

6A, 600V, UFS Series N-Channel IGBT with Anti-Parallel Hyperfast Diodes

January 1997

Features

- 6A, 600V at $T_C = 25^\circ\text{C}$
- 600V Switching SOA Capability
- Typical Fall Time 130ns at $T_J = 150^\circ\text{C}$
- Short Circuit Rating
- Low Conduction Loss
- Hyperfast Anti-Parallel Diode

Description

The HGTP3N60C3D, HGT1S3N60C3D, and HGT1S3N60C3DS are MOS gated high voltage switching devices combining the best features of MOSFETs and bipolar transistors. These devices have the high input impedance of a MOSFET and the low on-state conduction loss of a bipolar transistor. The much lower on-state voltage drop varies only moderately between 25°C and 150°C . The IGBT used is the development type TA49113. The diode used in anti-parallel with the IGBT is the development type TA49055.

The IGBT is ideal for many high voltage switching applications operating at moderate frequencies where low conduction losses are essential.

PACKAGING AVAILABILITY

PART NUMBER	PACKAGE	BRAND
HGTP3N60C3D	TO-220AB	G3N60C3D
HGT1S3N60C3D	TO-262AA	G3N60C3D
HGT1S3N60C3DS	TO-263AB	G3N60C3D

NOTE: When ordering, use the entire part number. Add the suffix 9A to obtain the TO-263AB variant in tape and reel, i.e. HGT1S3N60C3DS9A.

Formerly Developmental Type TA49119.

Packaging

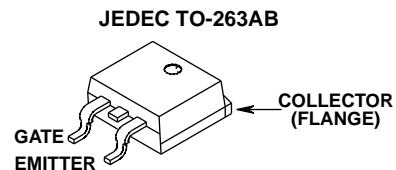
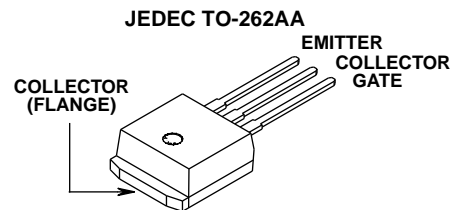
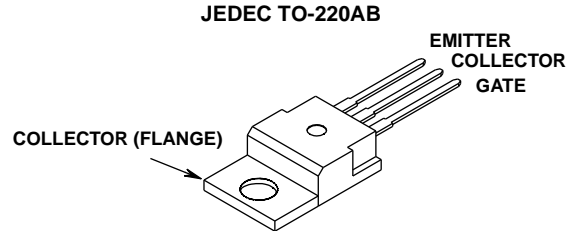

Terminal Diagram

N-CHANNEL ENHANCEMENT MODE

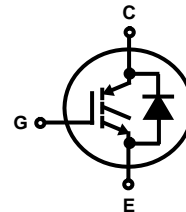

Absolute Maximum Ratings $T_C = 25^\circ\text{C}$, Unless Otherwise Specified

	HGTP3N60C3D, HGT1S3N60C3D HGT1S3N60C3DS	UNITS
Collector-Emitter Voltage	600	V
Collector Current Continuous	6	A
At $T_C = 25^\circ\text{C}$	3	A
At $T_C = 110^\circ\text{C}$	24	A
Collector Current Pulsed (Note 1)	± 20	V
Gate-Emitter Voltage Continuous	± 30	V
Gate-Emitter Voltage Pulsed	18A at 480V	SSOA
Switching Safe Operating Area at $T_J = 150^\circ\text{C}$, Fig. 14	33	W
Power Dissipation Total at $T_C = 25^\circ\text{C}$	0.27	W/ $^\circ\text{C}$
Power Dissipation Derating $T_C > 25^\circ\text{C}$	-40 to 150	$^\circ\text{C}$
Operating and Storage Junction Temperature Range	260	$^\circ\text{C}$
Maximum Lead Temperature for Soldering	8	μs
Short Circuit Withstand Time (Note 2) at $V_{GE} = 10\text{V}$, Fig 6		

NOTES:

1. Repetitive Rating: Pulse width limited by maximum junction temperature.
2. $V_{CE(PK)} = 360\text{V}$, $T_J = 125^\circ\text{C}$, $R_{GE} = 82\Omega$.

HGTP3N60C3D, HGT1S3N60C3D, HGT1S3N60C3DS

Electrical Specifications $T_C = 25^\circ\text{C}$, Unless Otherwise Specified

PARAMETER	SYMBOL	TEST CONDITIONS	MIN	TYP	MAX	UNITS	
Collector-Emitter Breakdown Voltage	BV_{CES}	$I_C = 250\mu\text{A}$, $V_{GE} = 0\text{V}$	600	-	-	V	
Collector-Emitter Leakage Current	I_{CES}	$V_{CE} = BV_{CES}$, $T_C = 25^\circ\text{C}$	-	-	250	μA	
		$V_{CE} = BV_{CES}$, $T_C = 150^\circ\text{C}$	-	-	2.0	mA	
Collector-Emitter Saturation Voltage	$V_{CE(SAT)}$	$I_C = I_{C110}$, $V_{GE} = 15\text{V}$	$T_C = 25^\circ\text{C}$	-	1.65	2.0	V
			$T_C = 150^\circ\text{C}$	-	1.85	2.2	V
Gate-Emitter Threshold Voltage	$V_{GE(TH)}$	$I_C = 250\mu\text{A}$, $V_{CE} = V_{GE}$	$T_C = 25^\circ\text{C}$	3.0	5.5	6.0	V
Gate-Emitter Leakage Current	I_{GES}	$V_{GE} = \pm 25\text{V}$	-	-	± 250	nA	
Switching SOA	SSOA	$T_J = 150^\circ\text{C}$ $R_G = 82\Omega$ $V_{GE} = 15\text{V}$ $L = 1\text{mH}$	$V_{CE(PK)} = 480\text{V}$	18	-	-	A
			$V_{CE(PK)} = 600\text{V}$	2	-	-	A
Gate-Emitter Plateau Voltage	V_{GEP}	$I_C = I_{C110}$, $V_{CE} = 0.5 BV_{CES}$	-	8.3	-	V	
On-State Gate Charge	$Q_{G(ON)}$	$I_C = I_{C110}$, $V_{CE} = 0.5 BV_{CES}$	$V_{GE} = 15\text{V}$	-	10.8	13.5	nC
			$V_{GE} = 20\text{V}$	-	13.8	17.3	nC
Current Turn-On Delay Time	$t_{D(ON)I}$	$T_J = 150^\circ\text{C}$ $I_{CE} = I_{C110}$ $V_{CE(PK)} = 0.8 BV_{CES}$ $V_{GE} = 15\text{V}$ $R_G = 82\Omega$ $L = 1\text{mH}$	-	5	-	ns	
Current Rise Time	t_{RI}		-	10	-	ns	
Current Turn-Off Delay Time	$t_{D(OFF)I}$		-	325	400	ns	
Current Fall Time	t_{FI}		-	130	275	ns	
Turn-On Energy	E_{ON}		-	85	-	μJ	
Turn-Off Energy (Note 3)	E_{OFF}		-	245	-	μJ	
Diode Forward Voltage	V_{EC}	$I_{EC} = 3\text{A}$	-	2.0	2.5	V	
Diode Reverse Recovery Time	t_{RR}	$I_{EC} = 3\text{A}$, $dI_{EC}/dt = 200\text{A}/\mu\text{s}$	-	22	28	ns	
		$I_{EC} = 1\text{A}$, $dI_{EC}/dt = 200\text{A}/\mu\text{s}$	-	17	22	ns	
Thermal Resistance	$R_{\theta JC}$	IGBT	-	-	3.75	$^\circ\text{C}/\text{W}$	
		Diode	-	-	3.0	$^\circ\text{C}/\text{W}$	

NOTE:

3. Turn-Off Energy Loss (E_{OFF}) is defined as the integral of the instantaneous power loss starting at the trailing edge of the input pulse and ending at the point where the collector current equals zero ($I_{CE} = 0\text{A}$). The HGTP3N60C3D, HGT1S3N60C3D, and HGT1S3N60C3DS were tested per JEDEC standard No. 24-1 Method for Measurement of Power Device Turn-Off Switching Loss. This test method produces the true total Turn-Off Energy Loss. Turn-On losses include diode losses.

HARRIS SEMICONDUCTOR IGBT PRODUCT IS COVERED BY ONE OR MORE OF THE FOLLOWING U.S. PATENTS:

4,364,073	4,417,385	4,430,792	4,443,931	4,466,176	4,516,143	4,532,534	4,567,641
4,587,713	4,598,461	4,605,948	4,618,872	4,620,211	4,631,564	4,639,754	4,639,762
4,641,162	4,644,637	4,682,195	4,684,413	4,694,313	4,717,679	4,743,952	4,783,690
4,794,432	4,801,986	4,803,533	4,809,045	4,809,047	4,810,665	4,823,176	4,837,606
4,860,080	4,883,767	4,888,627	4,890,143	4,901,127	4,904,609	4,933,740	4,963,951

Typical Performance Curves

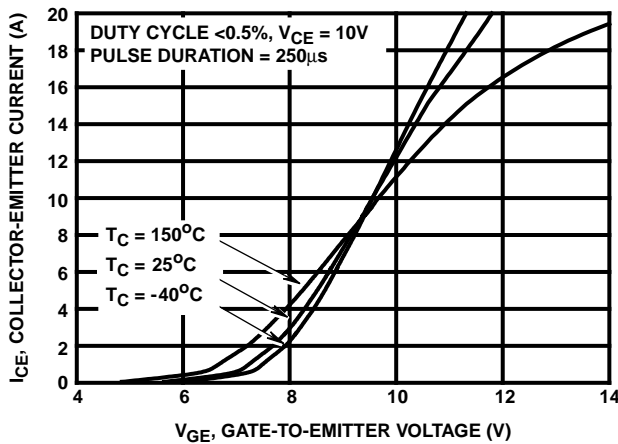

FIGURE 1. TRANSFER CHARACTERISTICS

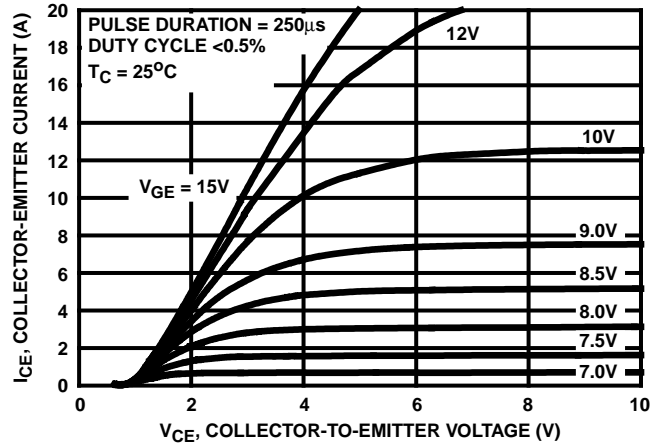

FIGURE 2. SATURATION CHARACTERISTICS

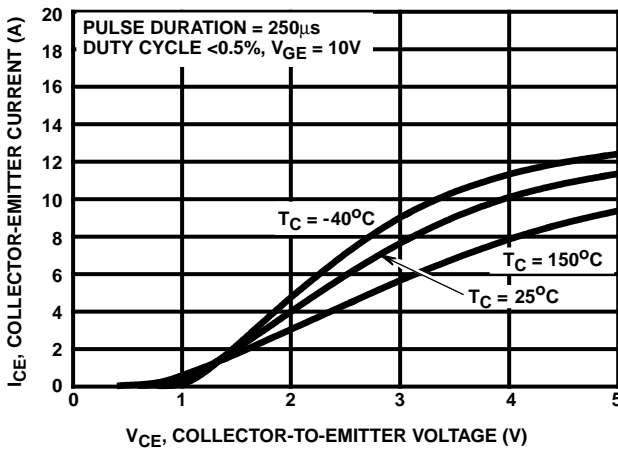

FIGURE 3. COLLECTOR-EMITTER ON - STATE VOLTAGE

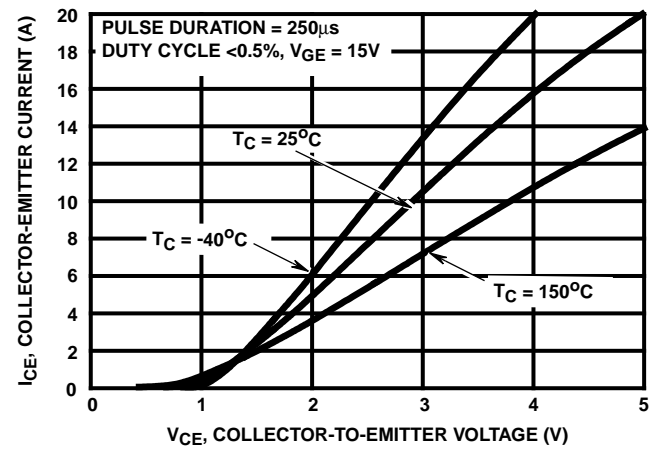

FIGURE 4. COLLECTOR-EMITTER ON - STATE VOLTAGE

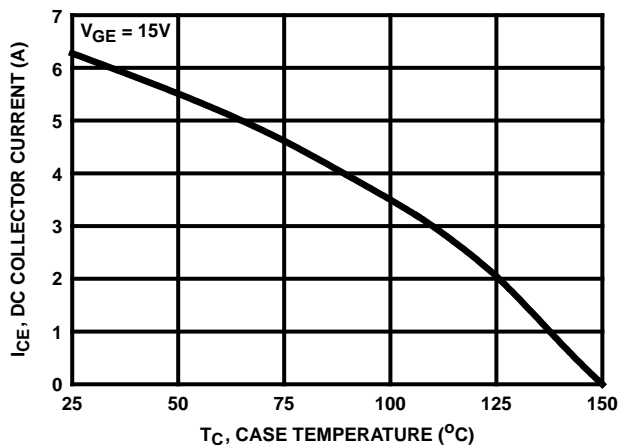

FIGURE 5. MAXIMUM DC COLLECTOR CURRENT AS A FUNCTION OF CASE TEMPERATURE

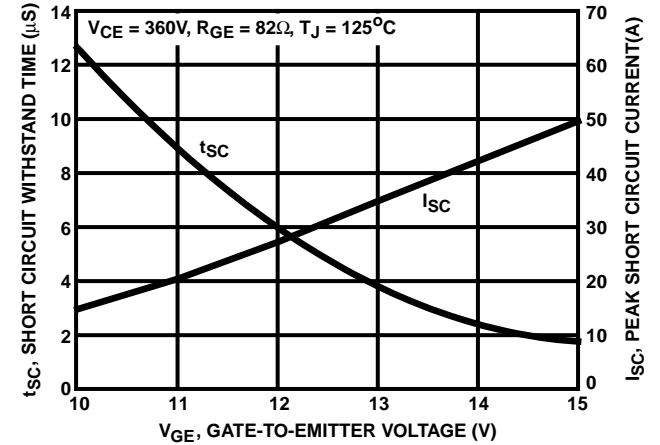

FIGURE 6. SHORT CIRCUIT WITHSTAND TIME

Typical Performance Curves (Continued)

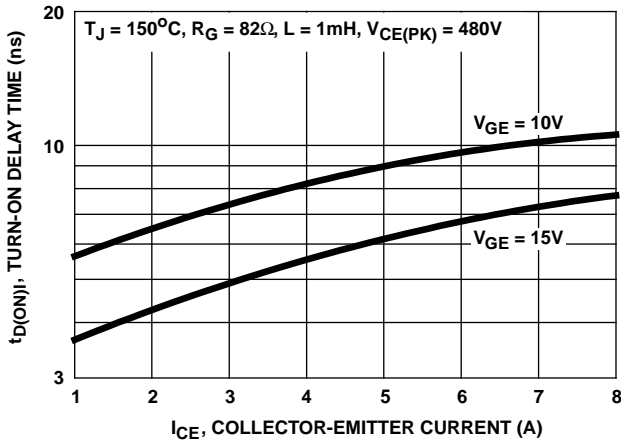

FIGURE 7. TURN-ON DELAY TIME AS A FUNCTION OF COLLECTOR-EMITTER CURRENT

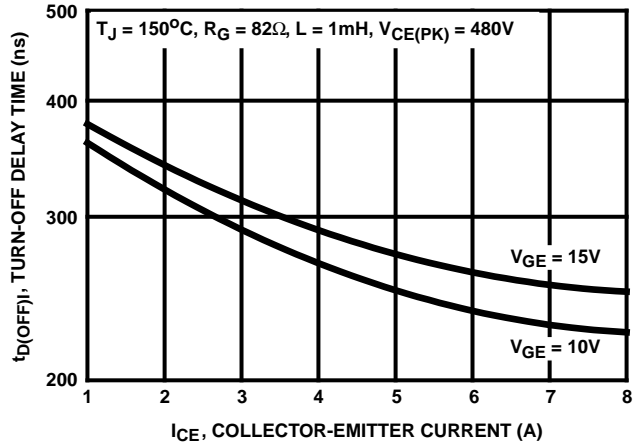

FIGURE 8. TURN-OFF DELAY TIME AS A FUNCTION OF COLLECTOR-EMITTER CURRENT

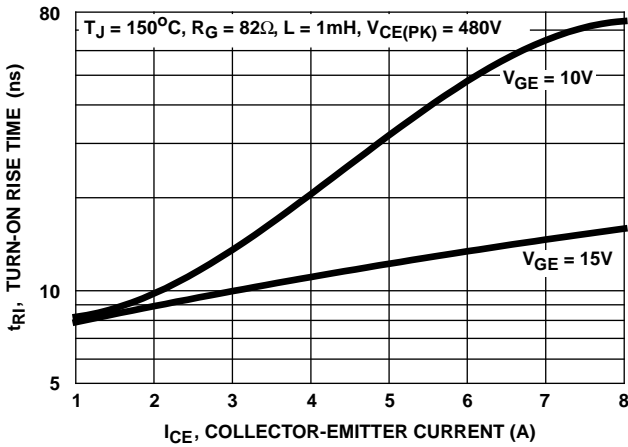

FIGURE 9. TURN-ON RISE TIME AS A FUNCTION OF COLLECTOR-EMITTER CURRENT

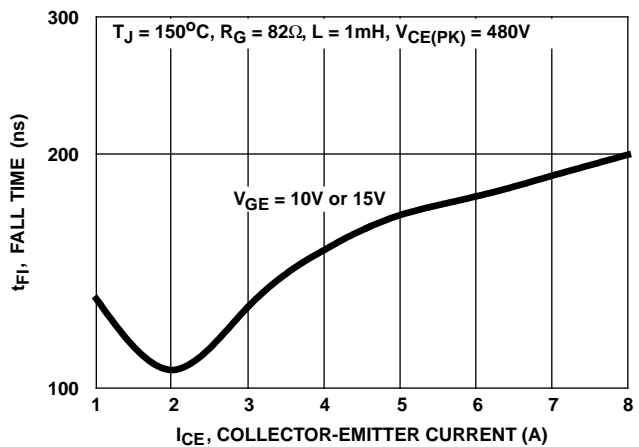

FIGURE 10. TURN-OFF FALL TIME AS A FUNCTION OF COLLECTOR-EMITTER CURRENT

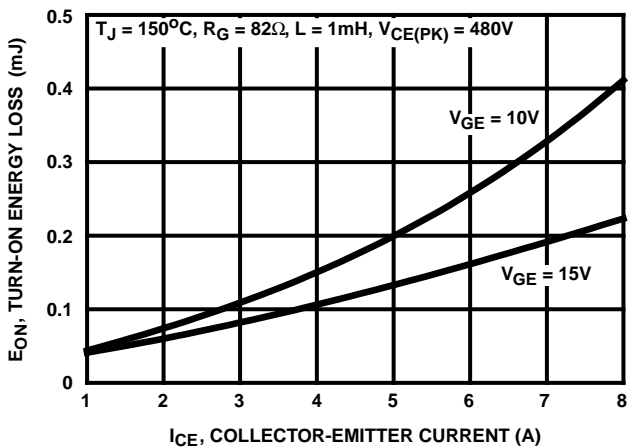

FIGURE 11. TURN-ON ENERGY LOSS AS A FUNCTION OF COLLECTOR-EMITTER CURRENT

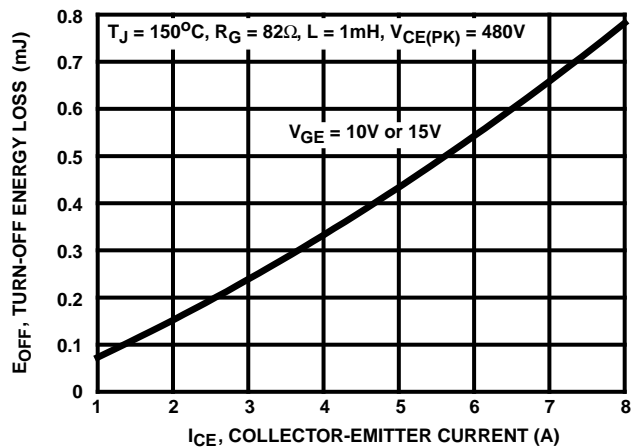

FIGURE 12. TURN-OFF ENERGY LOSS AS A FUNCTION OF COLLECTOR-EMITTER CURRENT

Typical Performance Curves (Continued)

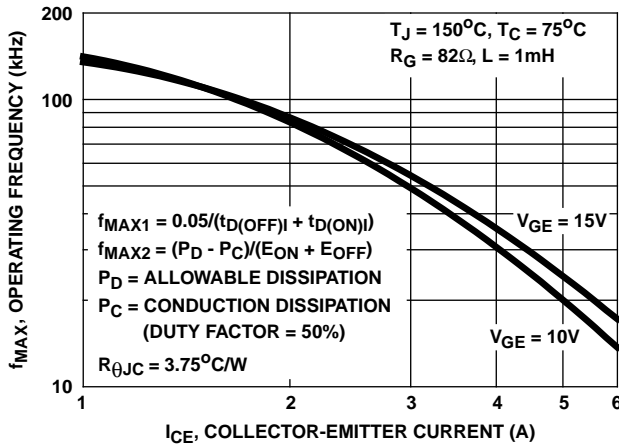

FIGURE 13. OPERATING FREQUENCY AS A FUNCTION OF COLLECTOR-EMITTER CURRENT

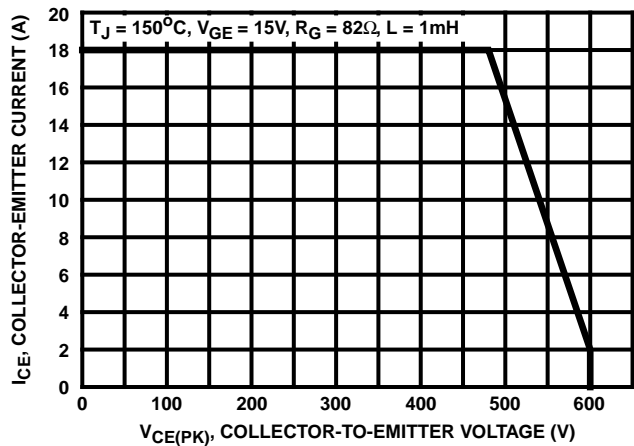

FIGURE 14. MINIMUM SWITCHING SAFE OPERATING AREA

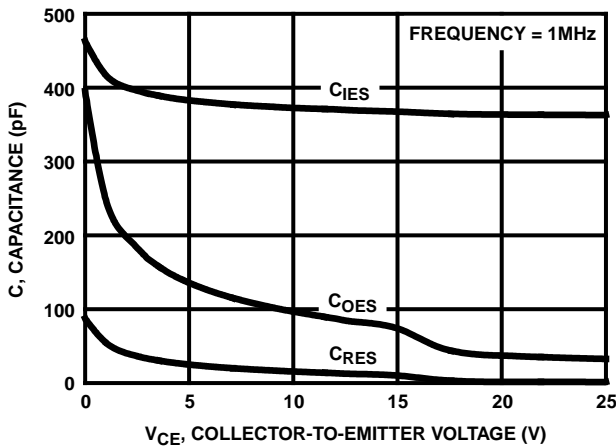

FIGURE 15. CAPACITANCE AS A FUNCTION OF COLLECTOR-EMITTER VOLTAGE

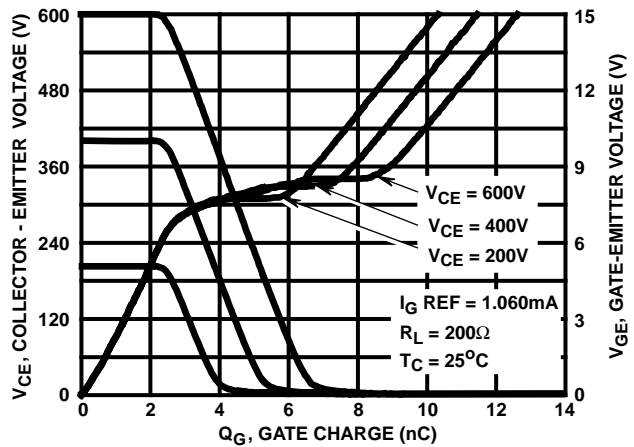

FIGURE 16. GATE CHARGE WAVEFORMS

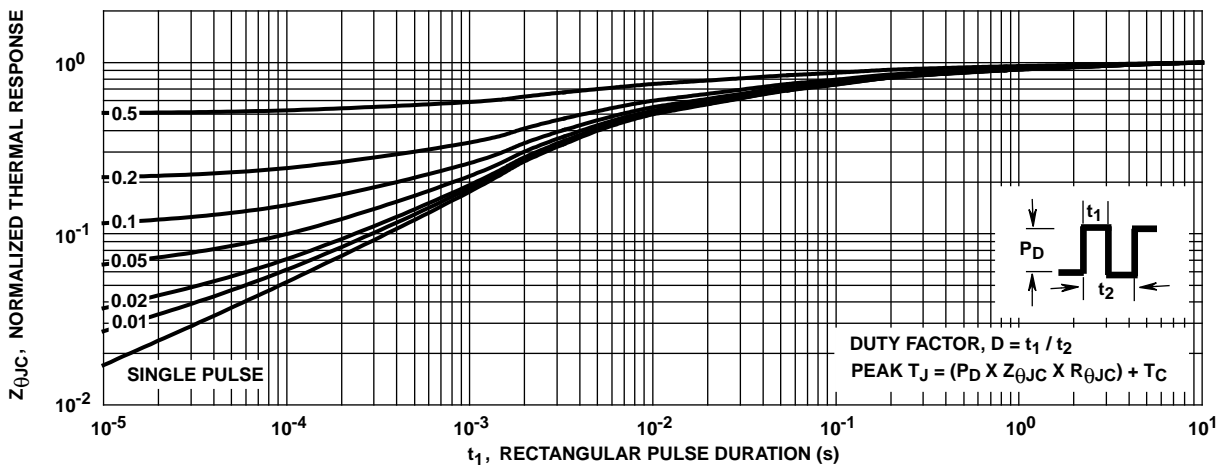

FIGURE 17. IGBT NORMALIZED TRANSIENT THERMAL IMPEDANCE, JUNCTION TO CASE

Typical Performance Curves (Continued)

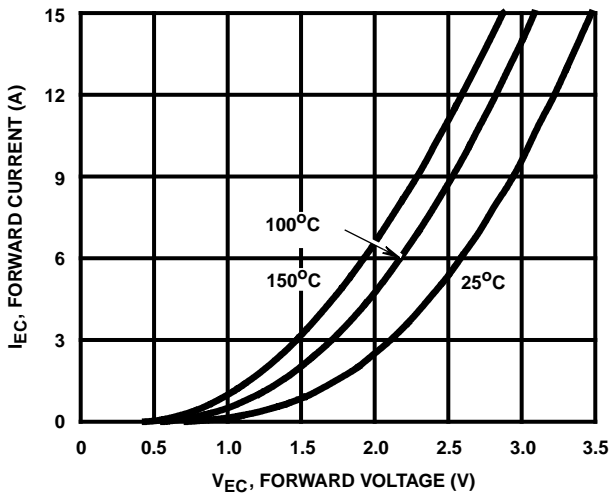

FIGURE 18. DIODE FORWARD CURRENT AS A FUNCTION OF FORWARD VOLTAGE DROP

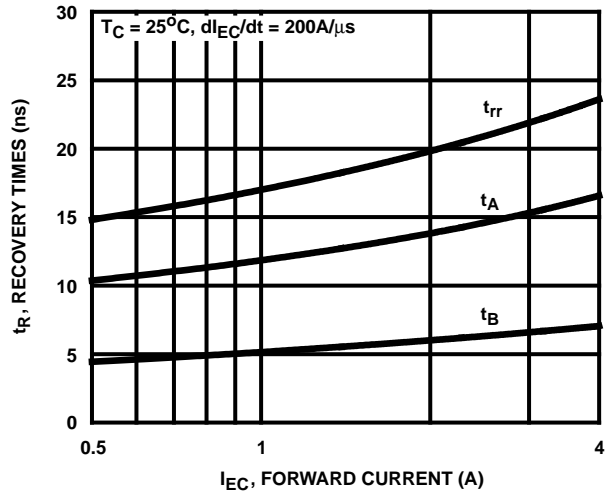

FIGURE 19. RECOVERY TIMES AS A FUNCTION OF FORWARD CURRENT

Test Circuit and Waveform

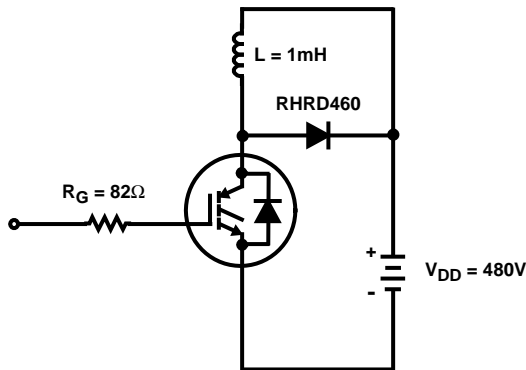

FIGURE 20. INDUCTIVE SWITCHING TEST CIRCUIT

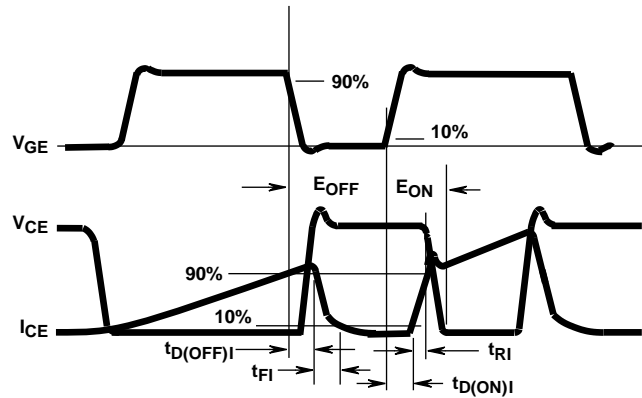

FIGURE 21. SWITCHING TEST WAVEFORMS

Operating Frequency Information

Operating frequency information for a typical device (Figure 13) is presented as a guide for estimating device performance for a specific application. Other typical frequency vs collector current (I_{CE}) plots are possible using the information shown for a typical unit in Figures 4, 7, 8, 11 and 12. The operating frequency plot (Figure 13) of a typical device shows f_{MAX1} or f_{MAX2} whichever is smaller at each point. The information is based on measurements of a typical device and is bounded by the maximum rated junction temperature.

f_{MAX1} is defined by $f_{MAX1} = 0.05 / (t_{D(OFF)|} + t_{D(ON)|})$. Dead-time (the denominator) has been arbitrarily held to 10% of the on-state time for a 50% duty factor. Other definitions are possible. $t_{D(OFF)|}$ and $t_{D(ON)|}$ are defined in Figure 21.

Device turn-off delay can establish an additional frequency limiting condition for an application other than T_{JMAX} . $t_{D(OFF)|}$ is important when controlling output ripple under a lightly loaded condition.

f_{MAX2} is defined by $f_{MAX2} = (P_D - P_C) / (E_{OFF} + E_{ON})$. The allowable dissipation (P_D) is defined by $P_D = (T_{JMAX} - T_C) / R_{\theta JC}$. The sum of device switching and conduction losses must not exceed P_D . A 50% duty factor was used (Figure 13) and the conduction losses (P_C) are approximated by $P_C = (V_{CE} \times I_{CE}) / 2$.

E_{ON} and E_{OFF} are defined in the switching waveforms shown in Figure 21. E_{ON} is the integral of the instantaneous power loss ($I_{CE} \times V_{CE}$) during turn-on and E_{OFF} is the integral of the instantaneous power loss during turn-off. All tail losses are included in the calculation for E_{OFF} ; i.e. the collector current equals zero ($I_{CE} = 0$).

Handling Precautions for IGBTs

Insulated Gate Bipolar Transistors are susceptible to gate-insulation damage by the electrostatic discharge of energy through the devices. When handling these devices, care should be exercised to assure that the static charge built in the handler's body capacitance is not discharged through the device. With proper handling and application procedures, however, IGBTs are currently being extensively used in production by numerous equipment manufacturers in military, industrial and consumer applications, with virtually no damage problems due to electrostatic discharge. IGBTs can be handled safely if the following basic precautions are taken:

1. Prior to assembly into a circuit, all leads should be kept shorted together either by the use of metal shorting springs or by the insertion into conductive material such as ECCOSORBD™ LD26 or equivalent.
2. When devices are removed by hand from their carriers, the hand being used should be grounded by any suitable means - for example, with a metallic wristband.

ECCOSORBD™ is a Trademark of Emerson and Cumming, Inc.

3. Tips of soldering irons should be grounded.
4. Devices should never be inserted into or removed from circuits with power on.
5. **Gate Voltage Rating** - Never exceed the gate-voltage rating of V_{GEM} . Exceeding the rated V_{GE} can result in permanent damage to the oxide layer in the gate region.
6. **Gate Termination** - The gates of these devices are essentially capacitors. Circuits that leave the gate open-circuited or floating should be avoided. These conditions can result in turn-on of the device due to voltage buildup on the input capacitor due to leakage currents or pickup.
7. **Gate Protection** - These devices do not have an internal monolithic zener diode from gate to emitter. If gate protection is required an external zener is recommended.

All Harris Semiconductor products are manufactured, assembled and tested under **ISO9000** quality systems certification.

Harris Semiconductor products are sold by description only. Harris Semiconductor reserves the right to make changes in circuit design and/or specifications at any time without notice. Accordingly, the reader is cautioned to verify that data sheets are current before placing orders. Information furnished by Harris is believed to be accurate and reliable. However, no responsibility is assumed by Harris or its subsidiaries for its use; nor for any infringements of patents or other rights of third parties which may result from its use. No license is granted by implication or otherwise under any patent or patent rights of Harris or its subsidiaries.

Sales Office Headquarters

For general information regarding Harris Semiconductor and its products, call **1-800-4-HARRIS**

NORTH AMERICA

Harris Semiconductor
P. O. Box 883, Mail Stop 53-210
Melbourne, FL 32902
TEL: 1-800-442-7747
(407) 729-4984
FAX: (407) 729-5321

EUROPE

Harris Semiconductor
Mercure Center
100, Rue de la Fusee
1130 Brussels, Belgium
TEL: (32) 2.724.2111
FAX: (32) 2.724.22.05

ASIA

Harris Semiconductor PTE Ltd.
No. 1 Tannery Road
Cencon 1, #09-01
Singapore 1334
TEL: (65) 748-4200
FAX: (65) 748-0400

