

# HGTP7N60C3D, HGT1S7N60C3DS, HGT1S7N60C3D

## 14A, 600V, UFS Series N-Channel IGBT with Anti-Parallel Hyperfast Diodes

### General Description

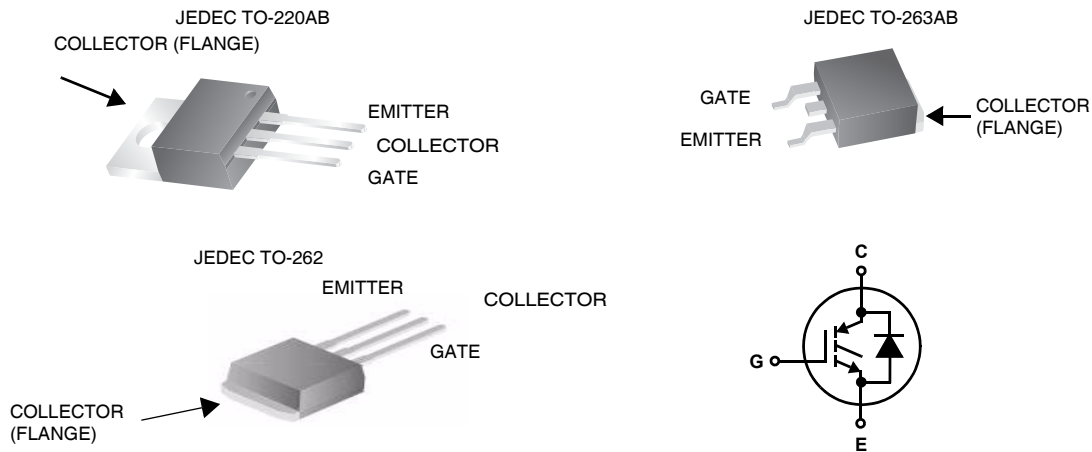
The HGTP7N60C3D, HGT1S7N60C3DS and HGT1S7N60C3D are MOS gated high voltage switching devices combining the best features of MOSFETs and bipolar transistors. These devices have the high input impedance of a MOSFET and the low on-state conduction loss of a bipolar transistor. The much lower on-state voltage drop varies only moderately between 25°C and 150°C. The IGBT used is developmental type TA49115. The diode used in anti-parallel with the IGBT is developmental type TA49057.

The IGBT is ideal for many high voltage switching applications operating at moderate frequencies where low conduction losses are essential, such as: AC and DC motor controls, power supplies and drivers for solenoids, relays and contactors.

Formerly Developmental Type TA49121.

### Features

- 14A, 600V at  $T_C = 25^\circ\text{C}$
- 600V Switching SOA Capability
- Typical Fall Time.....140ns at  $T_J = 150^\circ\text{C}$
- Short Circuit Rating
- Low Conduction Loss
- Hyperfast Anti-Parallel Diode



HGTP7N60C3D, HGT1S7N60C3DS, HGT1S7N60C3D 14A, 600V, UFS Series N-Channel IGBT with Anti-Parallel Hyperfast Diodes

### Absolute Maximum Ratings $T_A = 25^\circ\text{C}$ unless otherwise noted

Symbol	Parameter	Ratings	Units
$BV_{CES}$	Collector to Emitter Voltage	600	V
$I_{C25}$	Collector Current Continuous At $T_C = 25^\circ\text{C}$	14	A
$I_{C110}$	Collector Current Continuous At $T_C = 110^\circ\text{C}$	7	A
$I(AVG)$	Average Diode Forward Current at $110^\circ\text{C}$	8	A
$I_{CM}$	Collector Current Pulsed (Note 1)	56	A
$V_{GES}$	Gate to Emitter Voltage Continuous	$\pm 20$	V
$V_{GEM}$	Gate to Emitter Voltage Pulsed	$\pm 30$	V
SSOA	Switching Safe Operating Area at $T_J = 150^\circ\text{C}$ (Figure 14)	40A at 480V	
$P_D$	Power Dissipation Total at $T_C = 25^\circ\text{C}$	60	W
	Power Dissipation Derating $T_C > 25^\circ\text{C}$	0.487	W/ $^\circ\text{C}$
$T_J, T_{STG}$	Operating and Storage Junction Temperature Range	-40 to 150	$^\circ\text{C}$
$T_L$	Maximum Lead Temperature for Soldering	260	$^\circ\text{C}$
$t_{SC}$	Short Circuit Withstand Time (Note 2) at $V_{GE} = 15\text{V}$	1	$\mu\text{s}$
	Short Circuit Withstand Time (Note 2) at $V_{GE} = 10\text{V}$	8	$\mu\text{s}$

CAUTION: Stresses above those listed in "Absolute Maximum Ratings" may cause permanent damage to the device. This is a stress only rating and operation of the device at these or any other conditions above those indicated in the operational sections of this specification is not implied.

NOTES:

1. Repetitive Rating: Pulse width limited by maximum junction temperature.
2.  $V_{CE(PK)} = 360\text{V}$ ,  $T_J = 125^\circ\text{C}$ ,  $R_G = 50\text{W}$ .

### Thermal Characteristics

$R_{\theta JC}$	Thermal Resistance IGBT	2.1	$^\circ\text{C/W}$
	Thermal Resistance Diode	2.0	$^\circ\text{C/W}$

### Package Marking and Ordering Information

Part Number	Package	Brand
HGTP7N60C3D	TO-220AB	G7N60C3D
HGT1S7N60C3DS	TO-263AB	G7N60C3D
HGT1S7N60C3D	TO-262	G7N60C3D

NOTES: When ordering, use the entire part number. Add the suffix 9A to obtain the TO-263AB variant in tape and reel, i.e. HGT1S7N60C3DS9A.

**Electrical Characteristics**  $T_A = 25^\circ\text{C}$  unless otherwise noted

Symbol	Parameter	Test Conditions	Min	Typ	Max	Units
--------	-----------	-----------------	-----	-----	-----	-------

**Off Characteristics**

$BV_{CES}$	Collector to Emitter Breakdown Voltage	$I_C = 250\mu\text{A}, V_{GE} = 0\text{V}$	600	-	-	V	
$I_{CES}$	Collector to Emitter Leakage Current	$V_{CE} = BV_{CES}, T_C = 25^\circ\text{C}$ $V_{CE} = BV_{CES}, T_C = 150^\circ\text{C}$	-	-	250 2.0	$\mu\text{A}$ mA	
$I_{GES}$	Gate-Emitter Leakage Current	$V_{GE} = \pm 25\text{V}$	-	-	$\pm 250$	nA	
$V_{CE(SAT)}$	Collector to Emitter Saturation Voltage	$I_C = I_{C110},$ $V_{GE} = 15\text{V}$	$T_C = 25^\circ\text{C}$	-	1.6	2.0	V
			$T_C = 150^\circ\text{C}$	-	1.9	2.4	V

**On Characteristics**

$V_{GE(TH)}$	Gate-Emitter Threshold Voltage	$I_C = 250\mu\text{A}, V_{CE} = V_{GE},$ $T_C = 25^\circ\text{C}$	3.0	5.0	6.0	V	
SSOA	Switching SOA	$T_J = 150^\circ\text{C},$ $R_G = 50\Omega,$ $V_{GE} = 15\text{V},$ $L = 1\text{mH}$	$V_{CE(PK)} = 480\text{V}$	40	-	-	A
			$V_{CE(PK)} = 600\text{V}$	60	-	-	A
$V_{GEP}$	Gate to Emitter Plateau Voltage	$I_C = I_{C110}, V_{CE} = 0.5 BV_{CES}$	-	8	-	V	

**Switching Characteristics**

$t_{d(ON)}$	Current Turn-On Delay Time	$T_J = 150^\circ\text{C}$ $I_{CE} = I_{C110}$ $V_{CE(PK)} = 0.8 BV_{CES}$ $V_{GE} = 15\text{V}$ $R_G = 50\Omega$ $L = 1\text{mH}$	-	8.5	-	ns	
$t_{rl}$	Current Rise Time		-	11.5	-	ns	
$t_{d(OFF)}$	Current Turn-Off Delay Time		-	350	400	ns	
$t_{fl}$	Current Fall Time		-	140	275	ns	
$E_{ON}$	Turn-On Energy		-	165	-	$\mu\text{J}$	
$E_{OFF}$	Turn-Off Energy (Note 3)		-	600	-	$\mu\text{J}$	
$Q_{G(ON)}$	On-State Gate Charge	$I_C = I_{C110},$ $V_{CE} = 0.5 BV_{CES}$	$V_{GE} = 15\text{V}$	-	23	30	nC
			$V_{GE} = 20\text{V}$	-	30	38	nC

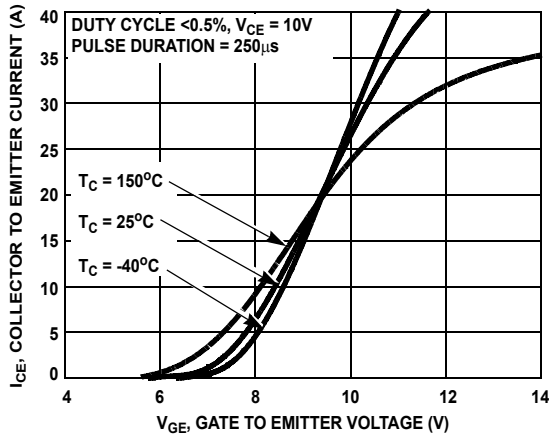
**Drain-Source Diode Characteristics and Maximum Ratings**

$V_{EC}$	Diode Forward Voltage	$I_{EC} = 7\text{A}$	-	1.9	2.5	V
$t_{rr}$	Diode Reverse Recovery Time	$I_{EC} = 7\text{A}, di_{EC}/dt = 200\text{A}/\mu\text{s}$	-	25	37	ns
		$I_{EC} = 1\text{A}, di_{EC}/dt = 200\text{A}/\mu\text{s}$	-	18	30	ns

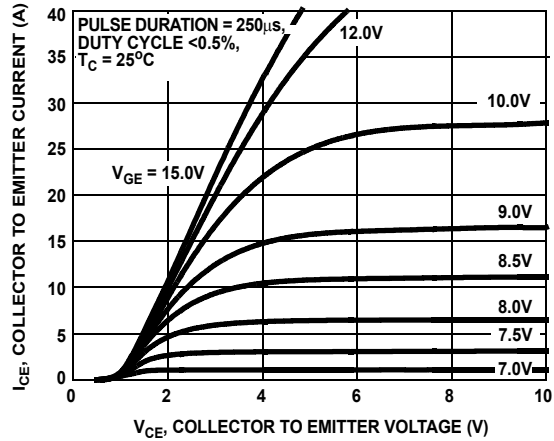
NOTES:

3. Turn-Off Energy Loss ( $E_{OFF}$ ) is defined as the integral of the instantaneous power loss starting at the trailing edge of the input pulse and ending at the point where the collector current equals zero ( $I_{CE} = 0\text{A}$ ). The HGT1S7N60C3D and HGT1S7N60C3DS were tested per JEDEC standard No. 24-1 Method for Measurement of Power Device Turn-Off Switching Loss. This test method produces the true total Turn-Off Energy Loss. Turn-On losses include diode losses.

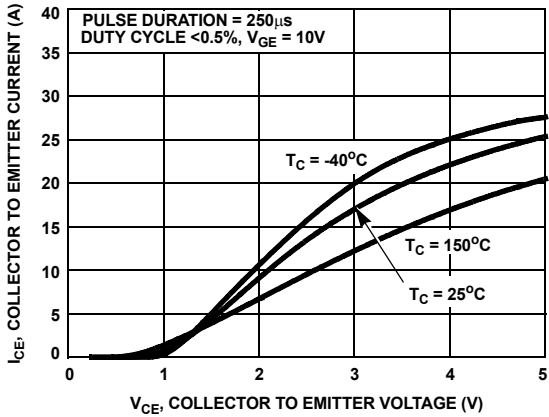
**Typical Performance Curves**



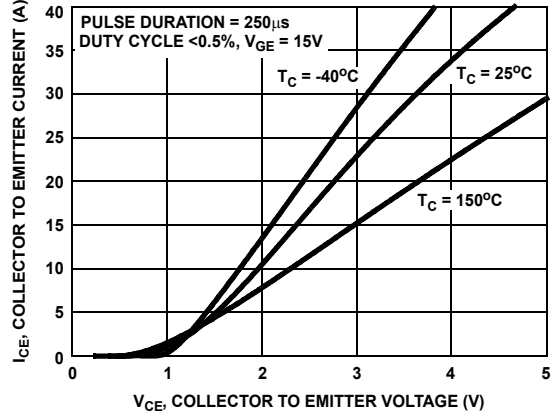
**Figure 1. TRANSFER CHARACTERISTICS**



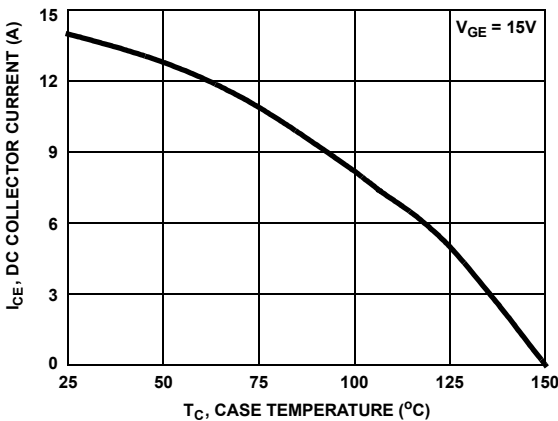
**Figure 2. SATURATION CHARACTERISTICS**



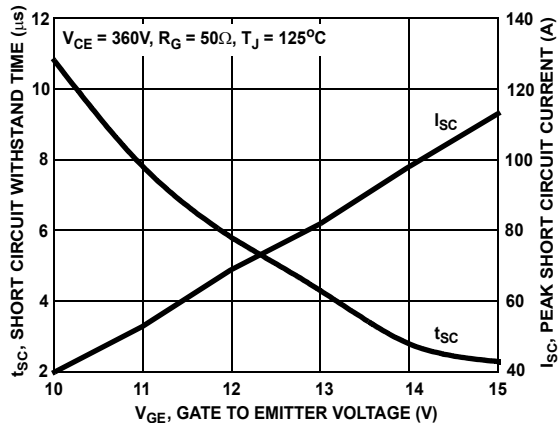
**Figure 3. COLLECTOR TO EMITTER ON-STATE VOLTAGE**



**Figure 4. COLLECTOR TO EMITTER ON-STATE VOLTAGE**

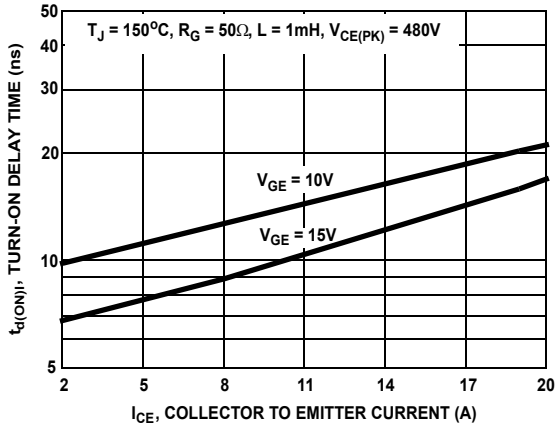


**Figure 5. MAXIMUM DC COLLECTOR CURRENT vs CASE TEMPERATURE**

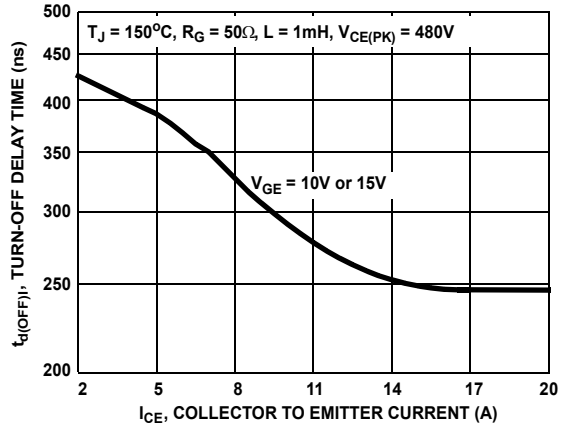


**Figure 6. SHORT CIRCUIT WITHSTAND TIME**

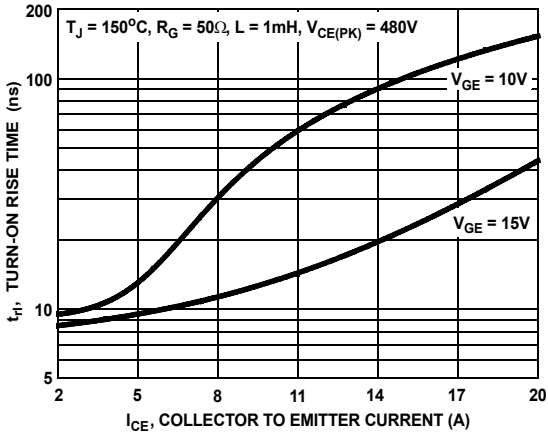
### Typical Performance Curves



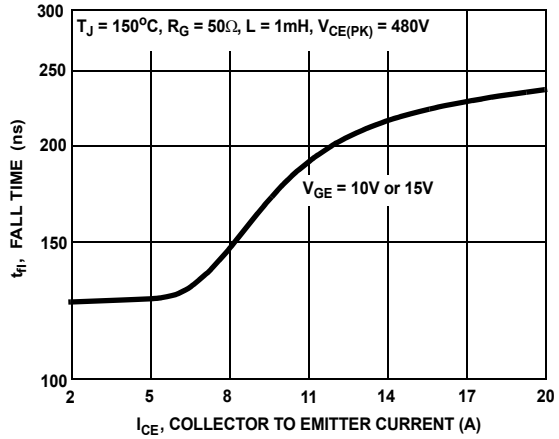
**Figure 7. TURN-ON DELAY TIME vs COLLECTOR TO EMITTER CURRENT**



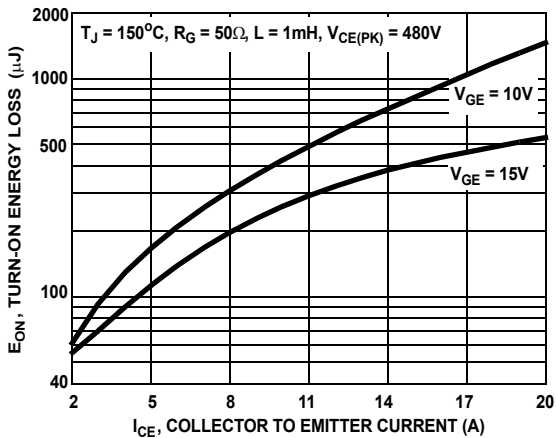
**Figure 8. TURN-OFF DELAY TIME vs COLLECTOR TO EMITTER CURRENT**



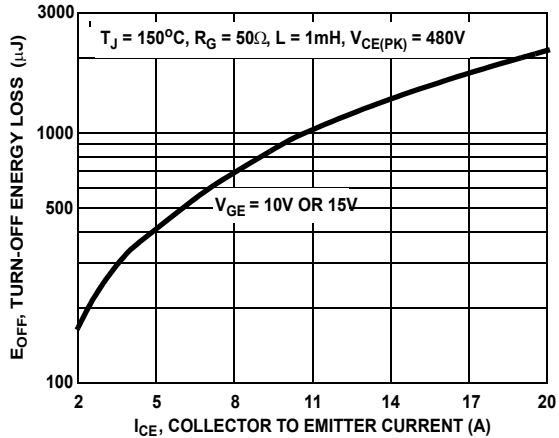
**Figure 9. TURN-ON RISE TIME vs COLLECTOR TO EMITTER CURRENT**



**Figure 10. Single Pulse Maximum Power Dissipation**



**Figure 11. TURN-ON ENERGY LOSS vs COLLECTOR TO EMITTER CURRENT**



**Figure 12. TURN-OFF ENERGY LOSS vs COLLECTOR TO EMITTER CURRENT**

Typical Performance Curves

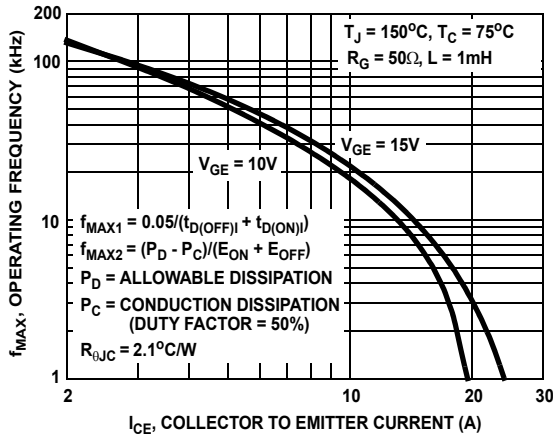


Figure 13. OPERATING FREQUENCY vs COLLECTOR TO EMITTER CURRENT

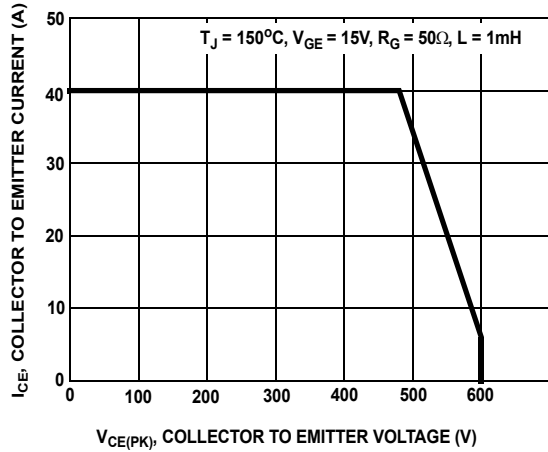


Figure 14. MINIMUM SWITCHING SAFE OPERATING AREA

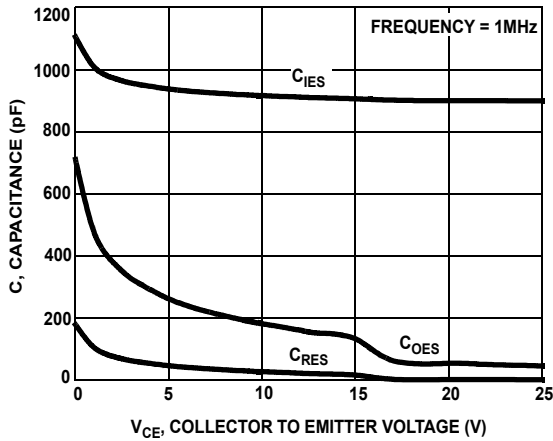


Figure 15. CAPACITANCE vs COLLECTOR TO EMITTER VOLTAGE

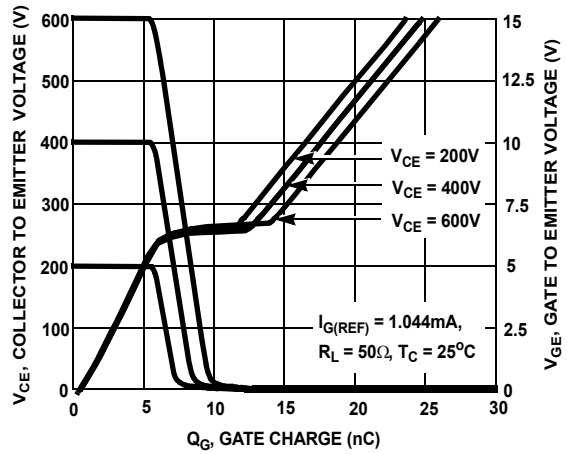


Figure 16. GATE CHARGE WAVEFORMS

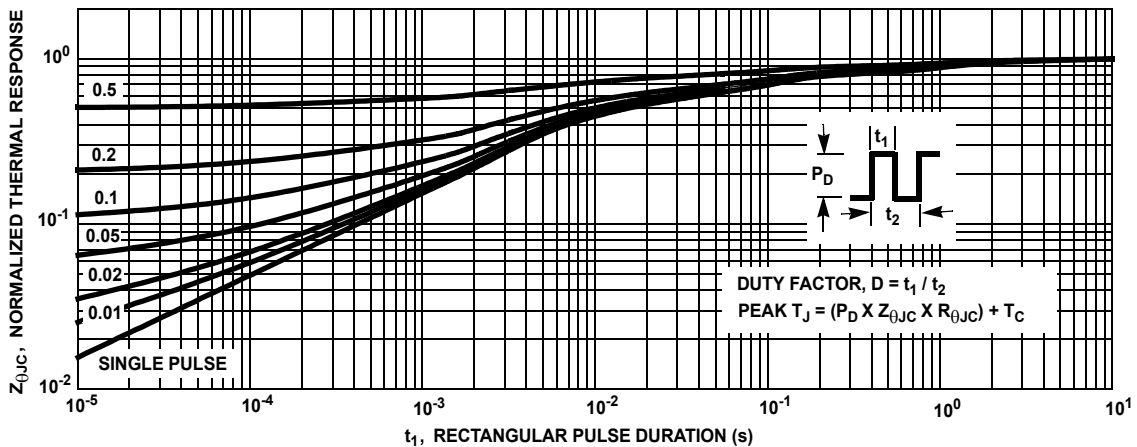
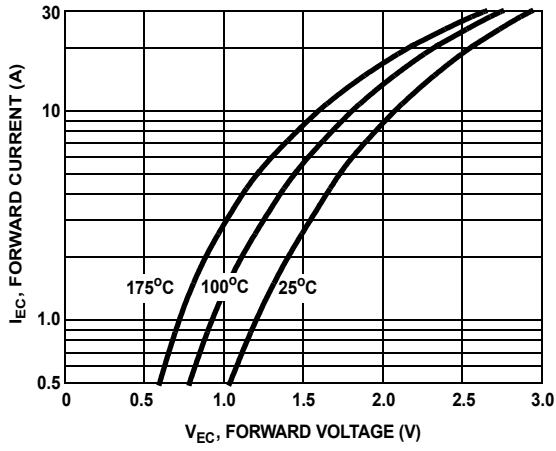
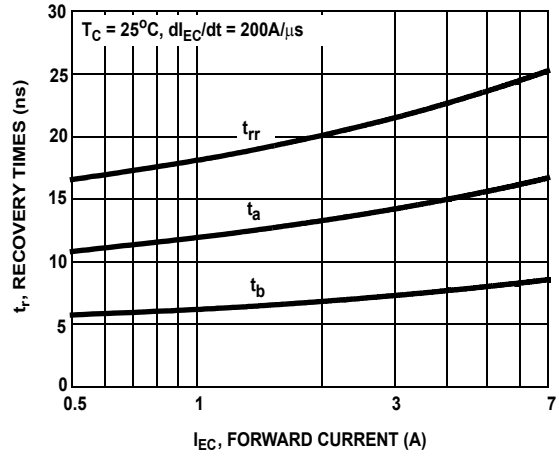


Figure 17. IGBT NORMALIZED TRANSIENT THERMAL IMPEDANCE, JUNCTION TO CASE

**Typical Performance Curves**

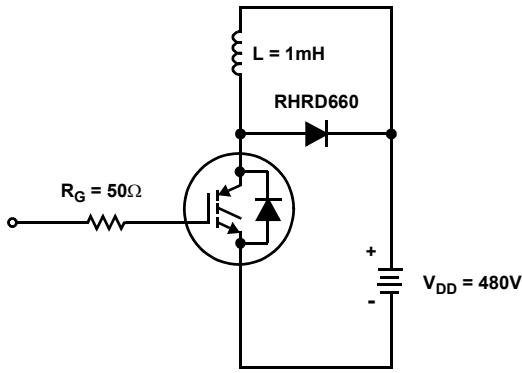


**Figure 18. DIODE FORWARD CURRENT vs FORWARD VOLTAGE DROP**

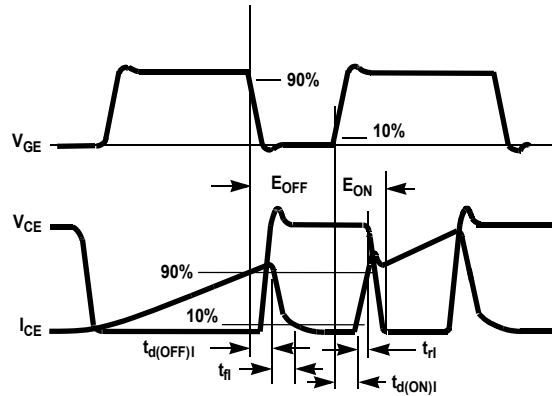


**Figure 19. RECOVERY TIMES vs FORWARD CURRENT**

**Test Circuit and Waveforms**



**Figure 20. INDUCTIVE SWITCHING TEST CIRCUIT**



**Figure 21. SWITCHING TEST WAVEFORMS**

## Handling Precautions for IGBTs

Insulated Gate Bipolar Transistors are susceptible to gate-insulation damage by the electrostatic discharge of energy through the devices. When handling these devices, care should be exercised to assure that the static charge built in the handler's body capacitance is not discharged through the device. With proper handling and application procedures, however, IGBTs are currently being extensively used in production by numerous equipment manufacturers in military, industrial and consumer applications, with virtually no damage problems due to electrostatic discharge. IGBTs can be handled safely if the following basic precautions are taken:

Prior to assembly into a circuit, all leads should be kept shorted together either by the use of metal shorting springs or by the insertion into conductive material such as ECCOSORB™ LD26 or equivalent.

When devices are removed by hand from their carriers, the hand being used should be grounded by any suitable means - for example, with a metallic wristband.

Tips of soldering irons should be grounded.

Devices should never be inserted into or removed from circuits with power on.

**Gate Voltage Rating** - Never exceed the gate-voltage rating of  $V_{GEM}$ . Exceeding the rated  $V_{GE}$  can result in permanent damage to the oxide layer in the gate region.

**Gate Termination** - The gates of these devices are essentially capacitors. Circuits that leave the gate open-circuited or floating should be avoided. These conditions can result in turn-on of the device due to voltage buildup on the input capacitor due to leakage currents or pickup.

**Gate Protection** - These devices do not have an internal monolithic zener diode from gate to emitter. If gate protection is required an external zener is recommended.

## Operating Frequency Information

Operating frequency information for a typical device (Figure 13) is presented as a guide for estimating device performance for a specific application. Other typical frequency vs collector current ( $I_{CE}$ ) plots are possible using the information shown for a typical unit in Figures 4, 7, 8, 11 and 12. The operating frequency plot (Figure 13) of a typical device shows  $f_{MAX1}$  or  $f_{MAX2}$  whichever is smaller at each point. The information is based on measurements of a typical device and is bounded by the maximum rated junction temperature.

$f_{MAX1}$  is defined by  $f_{MAX1} = 0.05 / (t_{d(OFF)I} + t_{d(ON)I})$ . Deadtime (the denominator) has been arbitrarily held to 10% of the on-state time for a 50% duty factor. Other definitions are possible.  $t_{d(OFF)I}$  and  $t_{d(ON)I}$  are defined in Figure 21.

Device turn-off delay can establish an additional frequency limiting condition for an application other than  $T_{JM}$ .  $t_{d(OFF)I}$  is important when controlling output ripple under a lightly loaded condition.

$f_{MAX2}$  is defined by  $f_{MAX2} = (P_D - P_C) / (E_{OFF} + E_{ON})$ . The allowable dissipation ( $P_D$ ) is defined by  $P_D = (T_{JM} - T_C) / R_{\theta JC}$ . The sum of device switching and conduction losses must not exceed  $P_D$ . A 50% duty factor was used (Figure 13) and the conduction losses ( $P_C$ ) are approximated by  $P_C = (V_{CE} \times I_{CE}) / 2$ .

$E_{ON}$  and  $E_{OFF}$  are defined in the switching waveforms shown in Figure 21.  $E_{ON}$  is the integral of the instantaneous power loss ( $I_{CE} \times V_{CE}$ ) during turn-on and  $E_{OFF}$  is the integral of the instantaneous power loss during turn-off. All tail losses are included in the calculation for  $E_{OFF}$ ; i.e. the collector current equals zero ( $I_{CE} = 0$ ).



## TRADEMARKS

The following are registered and unregistered trademarks Fairchild Semiconductor owns or is authorized to use and is not intended to be an exhaustive list of all such trademarks.

ACE <sup>x</sup> <sup>TM</sup>	FACT <sup>TM</sup>	<i>i-Lo</i> <sup>TM</sup>	PACMAN <sup>TM</sup>	SPM <sup>TM</sup>
ActiveArray <sup>TM</sup>	FACT Quiet Series <sup>TM</sup>	ImpliedDisconnect <sup>TM</sup>	POP <sup>TM</sup>	Stealth <sup>TM</sup>
Bottomless <sup>TM</sup>	FAST <sup>®</sup>	IntelliMAX <sup>TM</sup>	Power247 <sup>TM</sup>	SuperFET <sup>TM</sup>
Build it Now <sup>TM</sup>	FAST <sup>r</sup> <sup>TM</sup>	ISOPLANAR <sup>TM</sup>	PowerEdge <sup>TM</sup>	SuperSOT <sup>TM</sup> -3
CoolFET <sup>TM</sup>	FPST <sup>TM</sup>	LittleFET <sup>TM</sup>	PowerSaver <sup>TM</sup>	SuperSOT <sup>TM</sup> -6
CROSSVOLT <sup>TM</sup>	FRFET <sup>TM</sup>	MICROCOUPLER <sup>TM</sup>	PowerTrench <sup>®</sup>	SuperSOT <sup>TM</sup> -8
DOME <sup>TM</sup>	GlobalOptoisolator <sup>TM</sup>	MicroFET <sup>TM</sup>	QFET <sup>®</sup>	SyncFET <sup>TM</sup>
EcoSPARK <sup>TM</sup>	GTO <sup>TM</sup>	MicroPak <sup>TM</sup>	QS <sup>TM</sup>	TinyLogic <sup>®</sup>
E <sup>2</sup> C <sup>MOS</sup> <sup>TM</sup>	HiSeC <sup>TM</sup>	MICROWIRE <sup>TM</sup>	QT Optoelectronics <sup>TM</sup>	TINYOPTO <sup>TM</sup>
EnSigna <sup>TM</sup>	I <sup>2</sup> C <sup>TM</sup>	MSX <sup>TM</sup>	Quiet Series <sup>TM</sup>	TruTranslation <sup>TM</sup>
		MSXPro <sup>TM</sup>	RapidConfigure <sup>TM</sup>	UHC <sup>TM</sup>
Across the board. Around the world. <sup>TM</sup>		OCX <sup>TM</sup>	RapidConnect <sup>TM</sup>	UltraFET <sup>®</sup>
The Power Franchise <sup>®</sup>		OCXPro <sup>TM</sup>	μSerDes <sup>TM</sup>	UniFET <sup>TM</sup>
Programmable Active Droop <sup>TM</sup>		OPTOLOGIC <sup>®</sup>	SILENT SWITCHER <sup>®</sup>	VCX <sup>TM</sup>
		OPTOPLANAR <sup>TM</sup>	SMART START <sup>TM</sup>	Wire <sup>TM</sup>

## DISCLAIMER

FAIRCHILD SEMICONDUCTOR RESERVES THE RIGHT TO MAKE CHANGES WITHOUT FURTHER NOTICE TO ANY PRODUCTS HEREIN TO IMPROVE RELIABILITY, FUNCTION OR DESIGN. FAIRCHILD DOES NOT ASSUME ANY LIABILITY ARISING OUT OF THE APPLICATION OR USE OF ANY PRODUCT OR CIRCUIT DESCRIBED HEREIN; NEITHER DOES IT CONVEY ANY LICENSE UNDER ITS PATENT RIGHTS, NOR THE RIGHTS OF OTHERS.

## LIFE SUPPORT POLICY

FAIRCHILD'S PRODUCTS ARE NOT AUTHORIZED FOR USE AS CRITICAL COMPONENTS IN LIFE SUPPORT DEVICES OR SYSTEMS WITHOUT THE EXPRESS WRITTEN APPROVAL OF FAIRCHILD SEMICONDUCTOR CORPORATION.

As used herein:

1. Life support devices or systems are devices or systems which, (a) are intended for surgical implant into the body, or (b) support or sustain life, or (c) whose failure to perform when properly used in accordance with instructions for use provided in the labeling, can be reasonably expected to result in significant injury to the user.
2. A critical component is any component of a life support device or system whose failure to perform can be reasonably expected to cause the failure of the life support device or system, or to affect its safety or effectiveness.

## PRODUCT STATUS DEFINITIONS

### Definition of Terms

Datasheet Identification	Product Status	Definition
Advance Information	Formative or In Design	This datasheet contains the design specifications for product development. Specifications may change in any manner without notice.
Preliminary	First Production	This datasheet contains preliminary data, and supplementary data will be published at a later date. Fairchild Semiconductor reserves the right to make changes at any time without notice in order to improve design.
No Identification Needed	Full Production	This datasheet contains final specifications. Fairchild Semiconductor reserves the right to make changes at any time without notice in order to improve design.
Obsolete	Not In Production	This datasheet contains specifications on a product that has been discontinued by Fairchild semiconductor. The datasheet is printed for reference information only.

Rev. I16