



HIRP3010Q20-B30

SMD Type 850nm Infrared Emitter

Features

- Small double-end package
- Viewing Angle at X axis (Note3) = $\pm 65^\circ$
- High reliability
- Good spectral matching to Si photo detector
- RoHS compliance

Applications

- Infrared sensor
- Light barrier
- Infrared Touch Panel Solutions

Description

The HIRP3010Q20-B30 is a GaAlAs infrared LED housed in a miniature SMD package. The device has a peak wavelength of 850nm LED spectrally matched with phototransistor or photodiode.

Package Outline

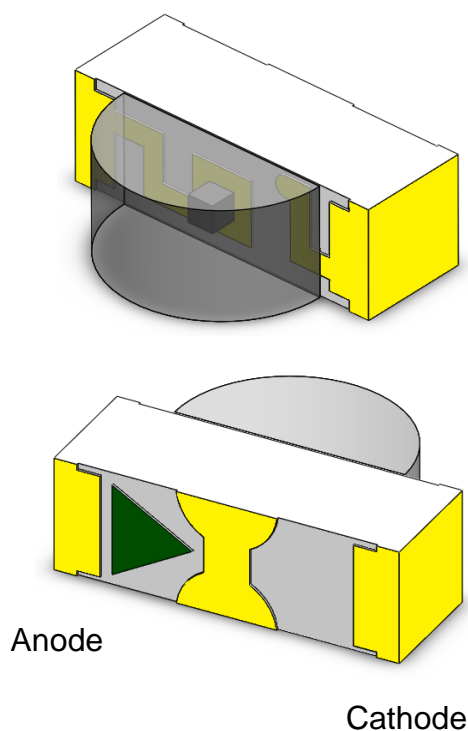

Schematic

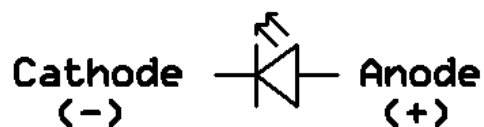



Absolute Maximum Rating at 25°C

Symbol	Parameters	Ratings	Units	Notes
I _F	Continuous Forward Current	70	mA	
I _{FP}	Peak Forward Current	0.7	A	1
V _R	Reverse Voltage	5	V	
T _{opr}	Operating Temperature	-40 ~ +85	°C	
T _{stg}	Storage Temperature	-40 ~ +100	°C	
T _{sol}	Soldering Temperature	260	°C	2
P _D	Power Dissipation at(or below) 25°C Free Air Temperature	140	mW	

Electro-Optical Characteristics *TA = 25°C (unless otherwise specified)*

Optical Characteristics

Symbol	Parameters	Test Conditions	Min	Typ	Max	Units	Notes
I _e	Radiant Intensity	I _F =20mA	1.0	2.1	-	mW/sr	
		I _F =70mA	-	7.0	-		
λ _p	Peak Wavelength	I _F =20mA	830	850	870	nm	
Δλ	Spectral Bandwidth	I _F =20mA	-	30	-	nm	
θ _{1/2}	Angle of Half Intensity (X)	I _F =20mA	-	±65	-	deg	3
	Angle of Half Intensity (Y)		-	±65	-		

Electrical Characteristics

Symbol	Parameters	Test Conditions	Min	Typ	Max	Units	Notes
V _F	Forward Voltage	I _F =20mA	1.30	1.40	1.7	V	
		I _F =70mA	1.40	1.56	2.0		
I _R	Reverse Current	V _R =5V	-	-	10	μA	

Notes:

- 1 : I_{FP} Conditions--Pulse Width ≤ 100μs and Duty ≤ 1%.
- 2 : Soldering time ≤ 5 seconds.
- 3 : Test condition :

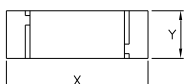



Typical Characteristic Curves

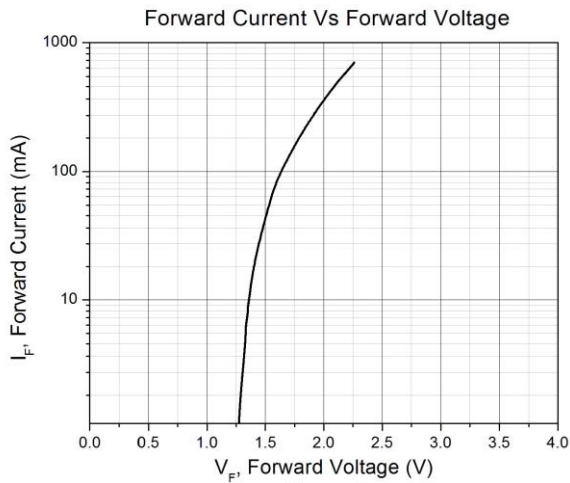

Figure 1

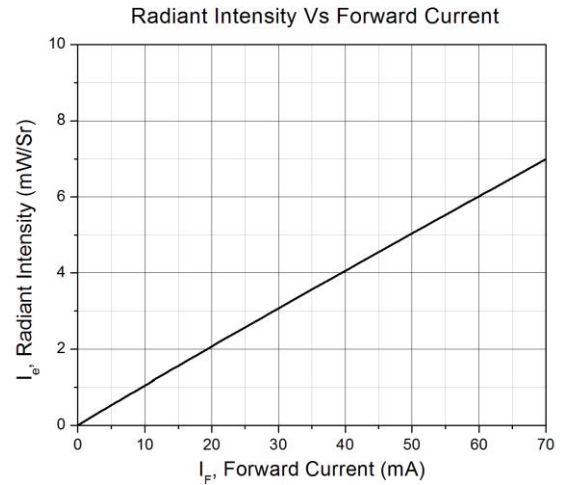

Figure 2

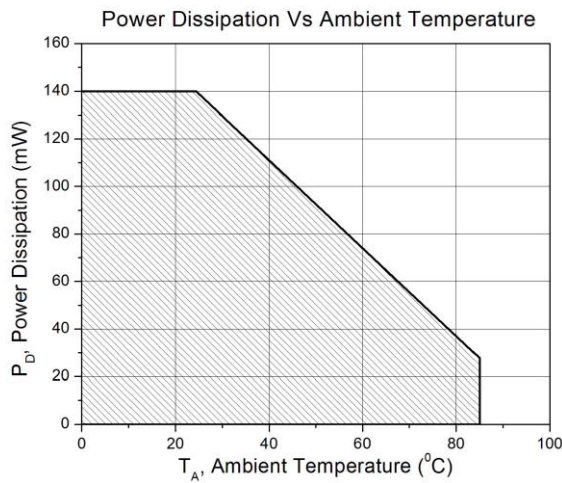

Figure 3

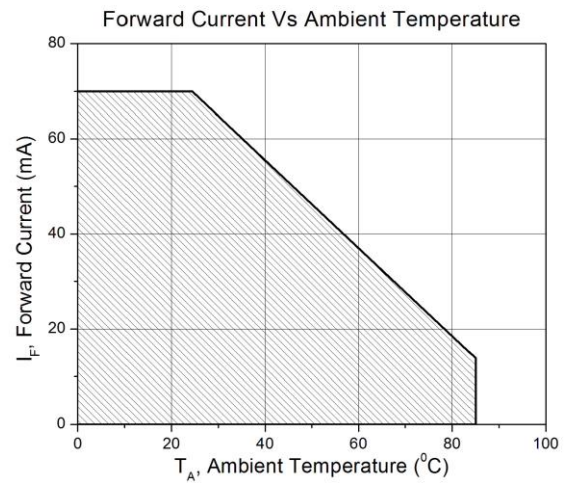

Figure 4

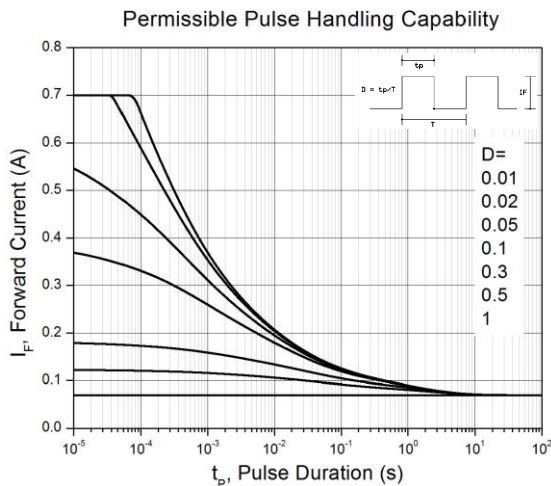

Figure 5

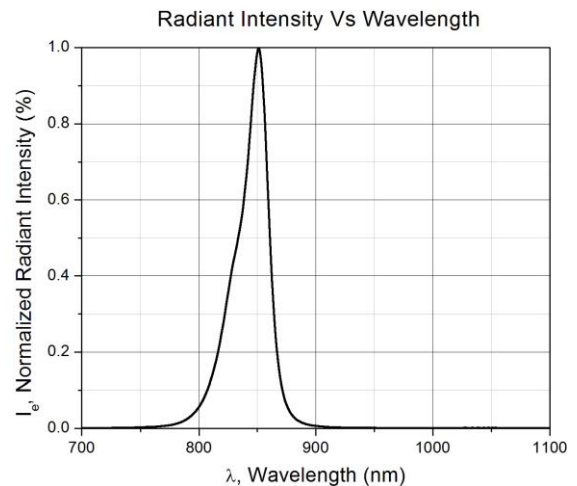

Figure 6



Typical Characteristic Curves

Angular Displacement at X axis

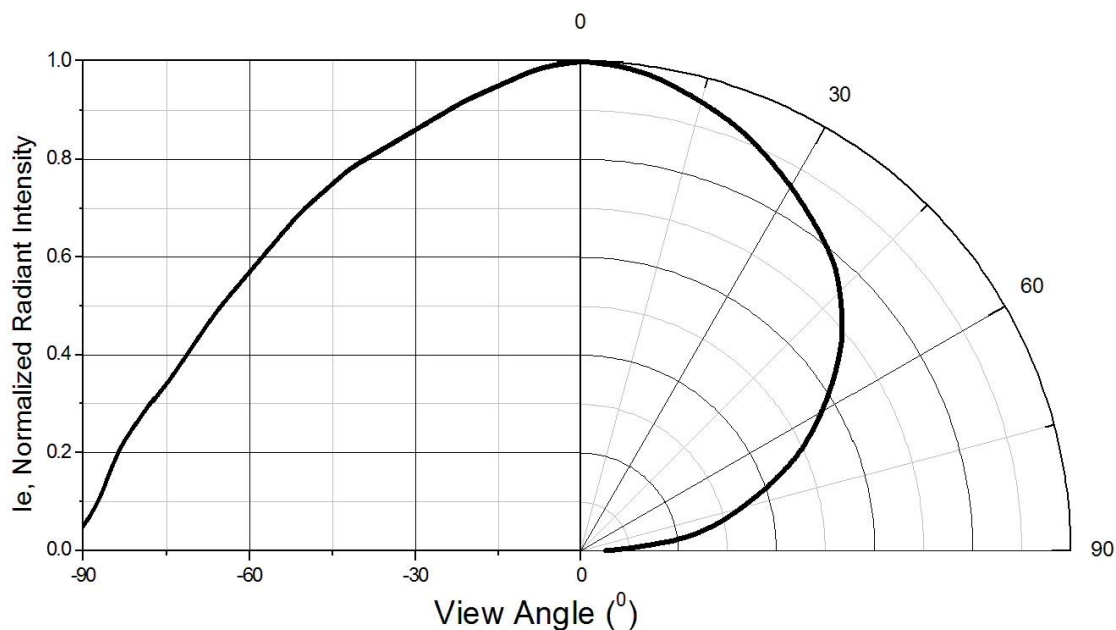

Figure 7

Angular Displacement at Y axis

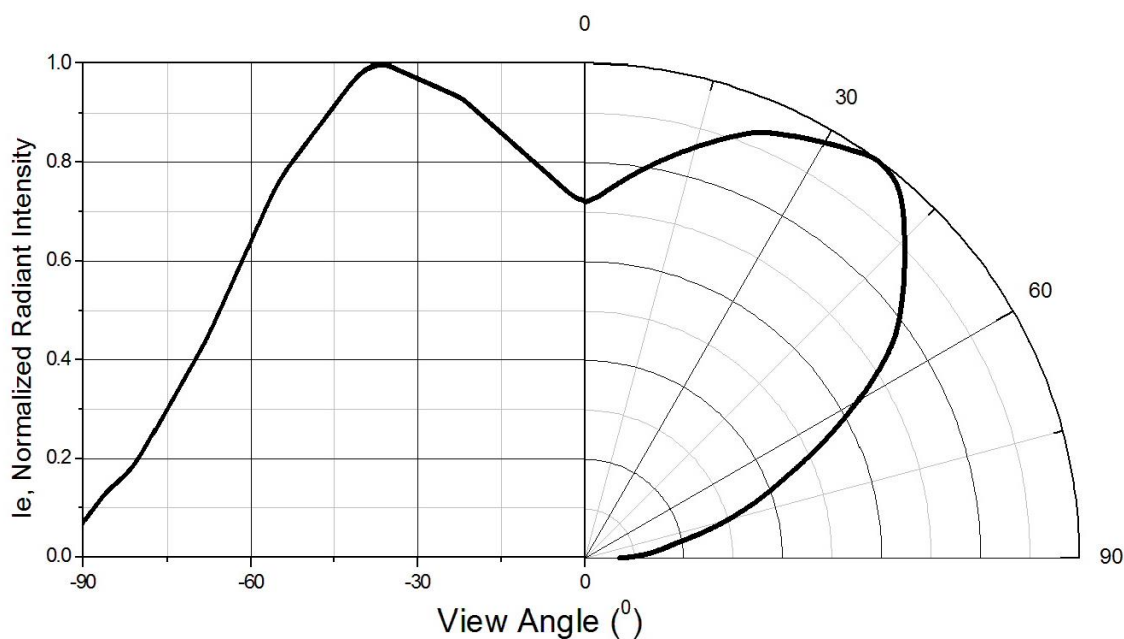

Figure 8



HIRP3010Q20-B30

SMD Type 850nm Infrared Emitter

Package Dimension *All dimensions are in mm, unless otherwise stated*

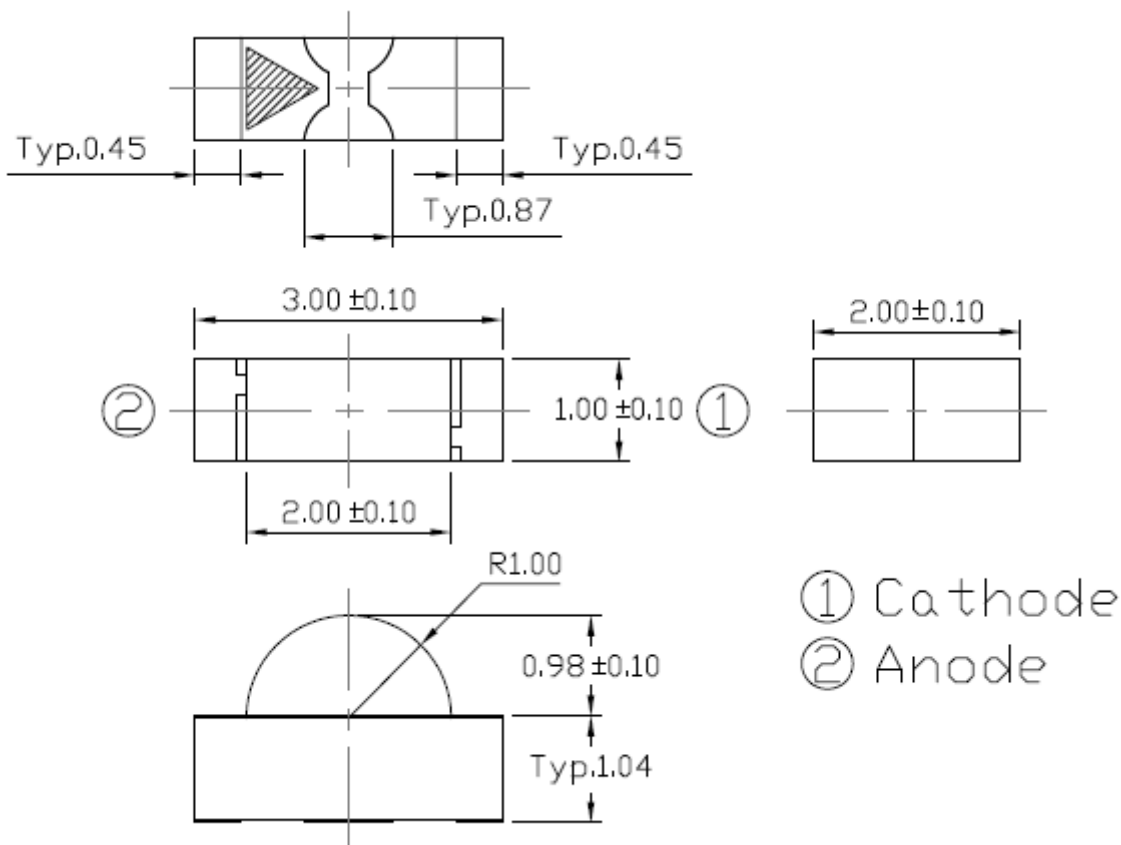

Recommended Soldering Mask *All dimensions are in mm, unless otherwise stated*

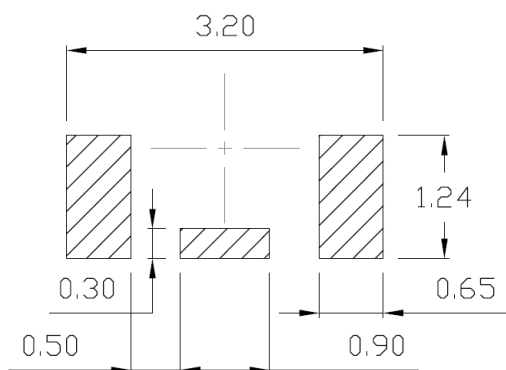

Ordering Information

Part Number	Description	Quantity
HIRP3010Q20-B30	Tape & Reel	3000 pcs



HIRP3010Q20-B30

SMD Type 850nm Infrared Emitter

Label Form Specification

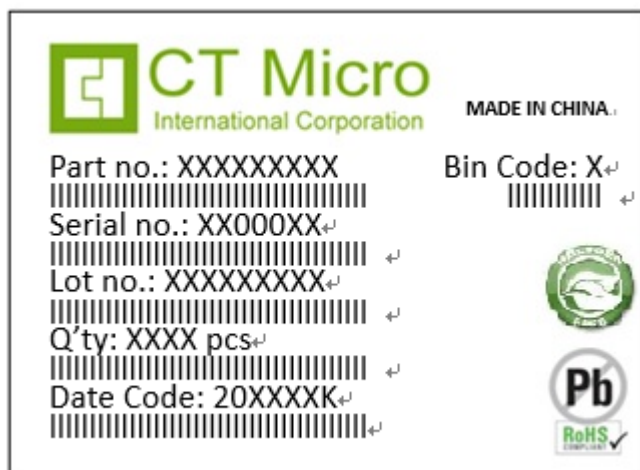

Part no: CTM Production Number

Serial no: Production Number

Lot no: Lot number

Q'ty: Packing Quantity

Date Code: Manufacture Date

Bin Code: 1e Ranks

MADE IN CHINA: Production Place

Storage Condition

1. Do not open moisture proof bag before the products are ready to use.
2. The moisture barrier bag should be stored at 30°C and 90%R.H. max. before opening.
Shelf life of non-opened bag is 12 months after the bag sealing date.
3. After opening the moisture barrier bag floor life is 168h at 30°C/60%RH. max. Unused LEDs should be resealed into moisture barrier bag. (Refer to J-STD-020 Standard)
4. If the moisture absorbent material has faded away or the LEDs have exceeded the storage time, baking treatment should be performed using the J-STD-033 Standard conditions.



Reflow Profile

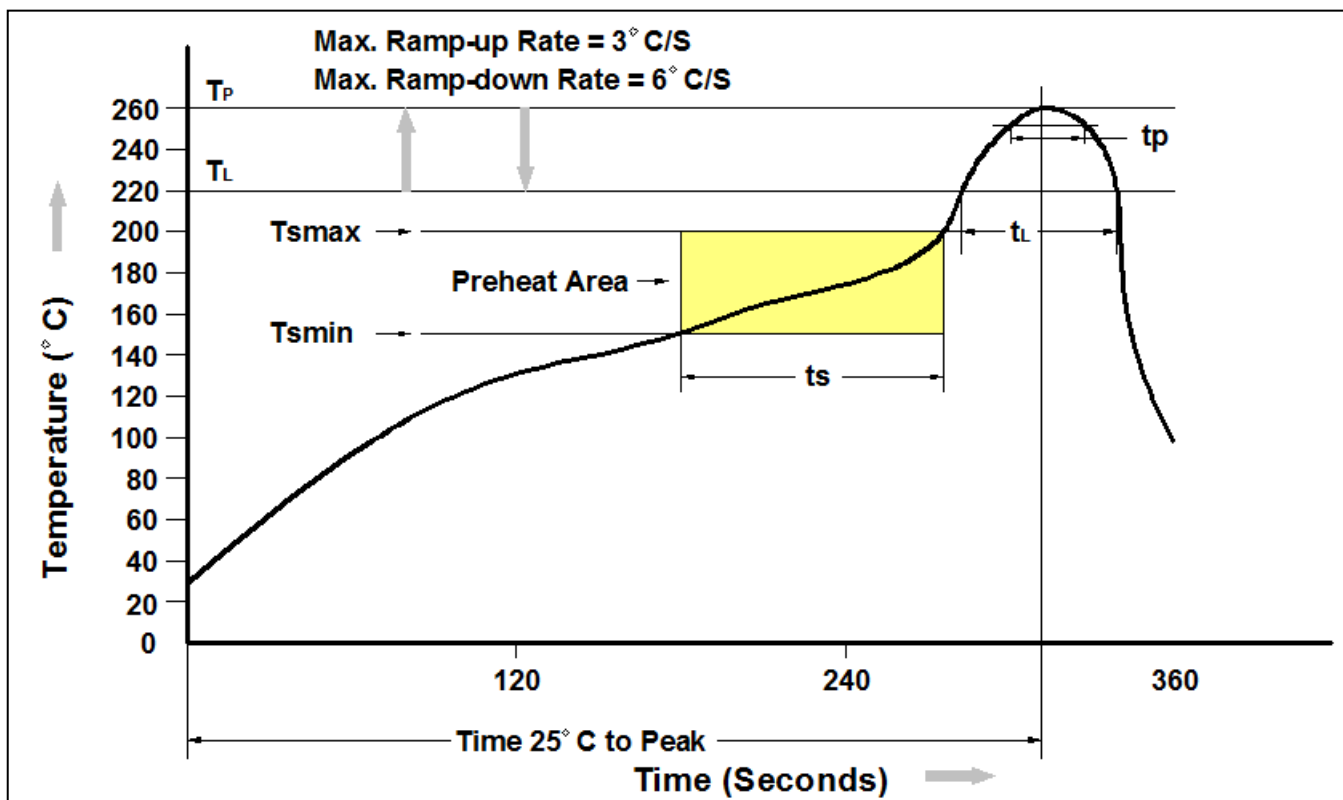

Profile Feature	Pb-Free Assembly Profile
Temperature Min. (T _{min})	150°C
Temperature Max. (T _{max})	200°C
Time (t _s) from (T _{min} to T _{max})	60-120 seconds
Ramp-up Rate (t _L to t _P)	3°C/second max.
Liquidous Temperature (T _L)	217°C
Time (t _L) Maintained Above (T _L)	60 – 150 seconds
Peak Body Package Temperature	260°C +0°C / -5°C
Time (t _P) within 5°C of 260°C	30 seconds
Ramp-down Rate (T _P to T _L)	6°C/second max
Time 25°C to Peak Temperature	8 minutes max.



DISCLAIMER

CT MICRO RESERVES THE RIGHT TO MAKE CHANGES WITHOUT FURTHER NOTICE TO ANY PRODUCTS HEREIN TO IMPROVE RELIABILITY, FUNCTION OR DESIGN. CT MICRO DOES NOT ASSUME ANY LIABILITY ARISING OUT OF THE APPLICATION OR USE OF ANY PRODUCT OR CIRCUIT DESCRIBED HEREIN; NEITHER DOES IT CONVEY ANY LICENSE UNDER ITS PATENT RIGHTS, NOR THE RIGHTS OF OTHERS.

CT MICRO ARE NOT AUTHORIZED FOR USE AS CRITICAL COMPONENTS IN LIFE SUPPORT DEVICES OR SYSTEMS WITHOUT EXPRESS WRITTEN APPROVAL OF CT MICRO INTERNATIONAL CORPORATION.

- 1. Life support devices or systems are devices or systems which, (a) are intended for surgical implant into the body, or (b) support or sustain life, or (c) whose failure to perform when properly used in accordance with instruction for use provided in the labelling, can be reasonably expected to result in significant injury to the user.*
- 2. A critical component is any component of a life support device or system whose failure to perform can be reasonably expected to cause the failure of the life support device or system, or to affect its safety or effectiveness.*