



HJ41C

NPN EPITAXIAL PLANAR TRANSISTOR

Description

The HJ41C is designed for use in general purpose amplifier and switching applications.

Absolute Maximum Ratings (Ta=25°C)

- Maximum Temperatures
 - Storage Temperature -55 ~ +150 °C
 - Junction Temperature +150 °C
- Maximum Power Dissipation
 - Total Power Dissipation (Tc=25°C) 20 W
- Maximum Voltages and Currents
 - BVCBO Collector to Base Voltage 100 V
 - BVCEO Collector to Emitter Voltage 100 V
 - BVEBO Emitter to Base Voltage 5 V
 - IC Collector Current 6 A

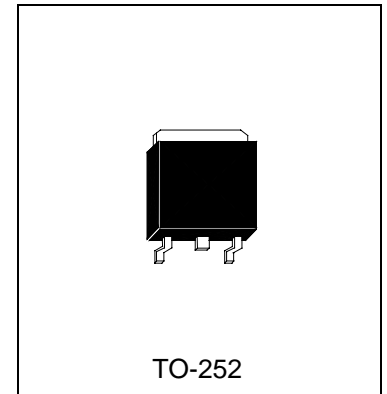

Characteristics (Ta=25°C)

Symbol	Min.	Typ.	Max.	Unit	Test Conditions
BVCBO	100	-	-	V	IC=1mA, IE=0
BVCEO	100	-	-	V	IC=30mA, IB=0
BVEBO	5	-	-	V	IC=1mA, IC=0
ICES	-	-	10	uA	VCE=100V, VEB=0
ICEO	-	-	50	uA	VCE=60V, IB=0
IEBO	-	-	500	uA	VEB=5V, IC=0
*VCE(sat)	-	-	1.5	V	IC=6A, IB=600mA
VBE(on)	-	-	2	V	VCE=4V, IC=6A
*hFE1	30	-	-		VCE=4V, IC=300mA
*hFE2	15	-	75		VCE=4V, IC=3A
fT	3	-	-	MHz	VCE=10V, IC=500mA, f=1MHz

*Pulse Test: Pulse Width ≤380us, Duty Cycle≤2%



Characteristics Curve

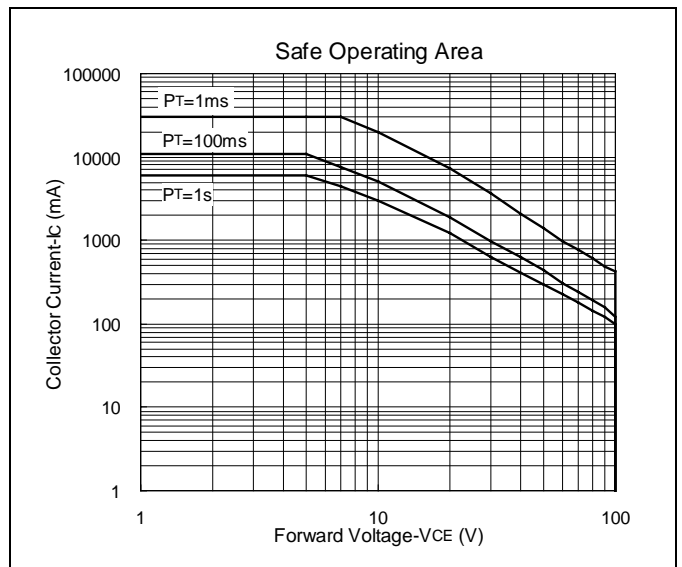
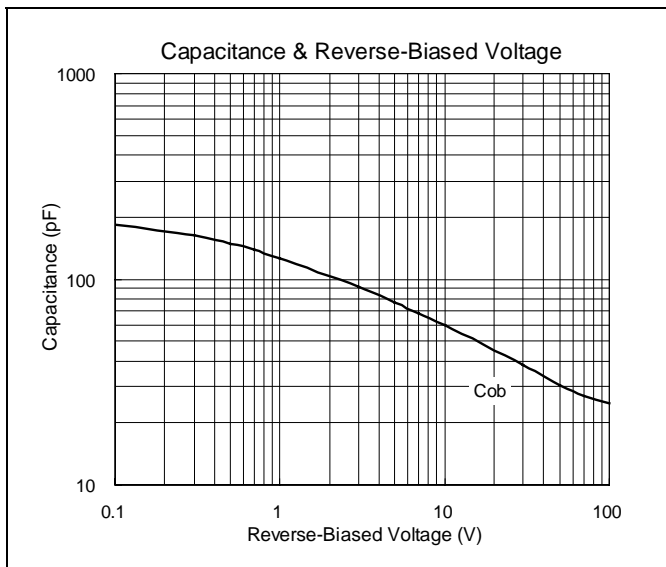
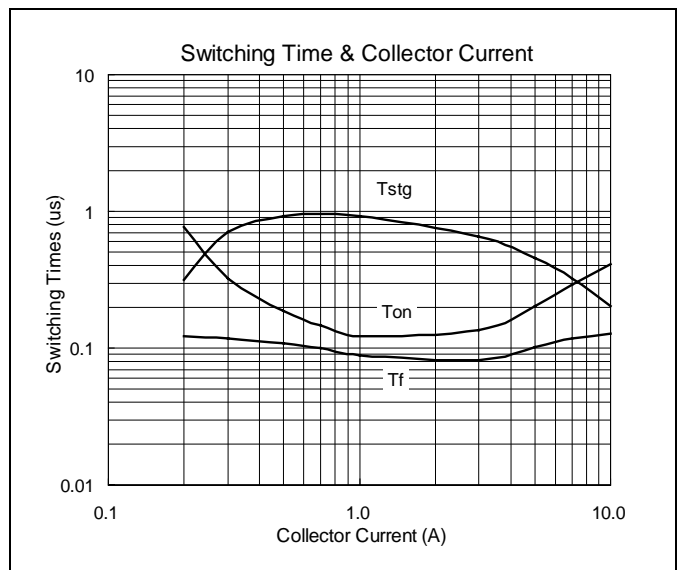
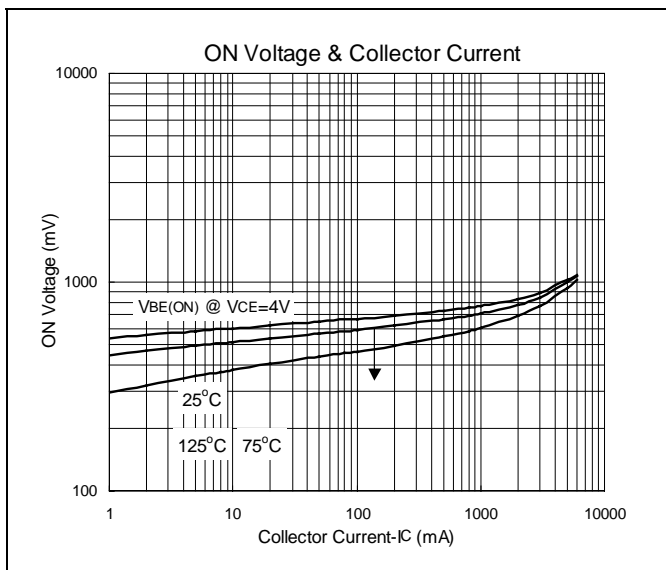
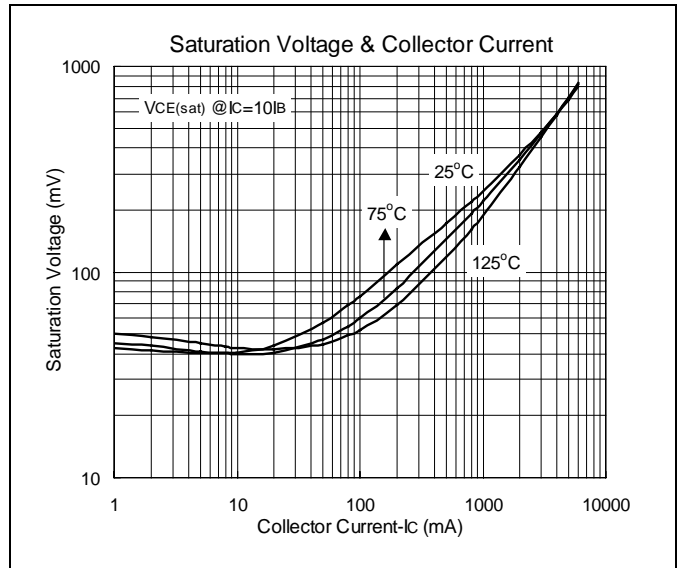
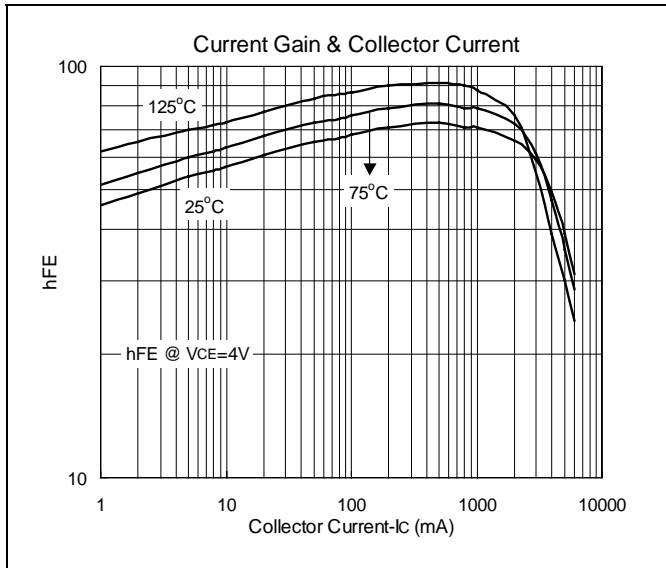



TO-252 Dimension

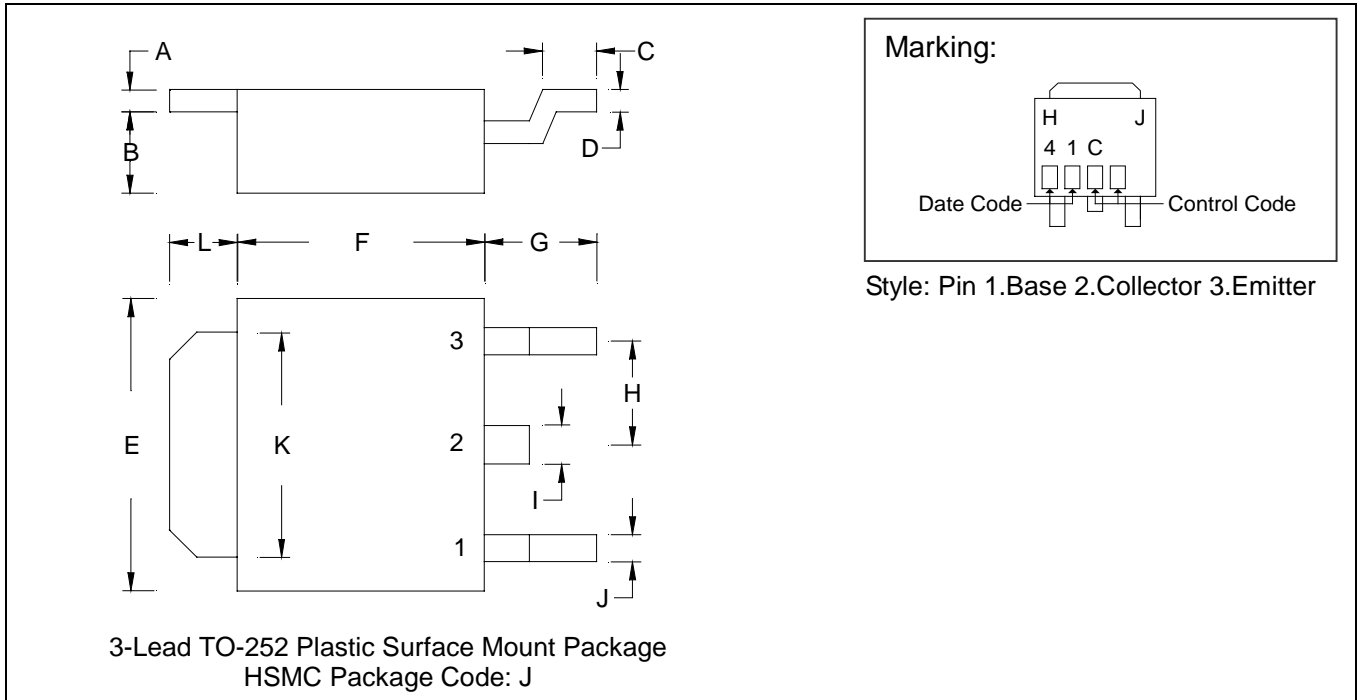

*: Typical

DIM	Inches		Millimeters		DIM	Inches		Millimeters	
	Min.	Max.	Min.	Max.		Min.	Max.	Min.	Max.
A	0.0177	0.0217	0.45	0.55	G	0.0866	0.1102	2.20	2.80
B	0.0650	0.0768	1.65	1.95	H	-	*0.0906	-	*2.30
C	0.0354	0.0591	0.90	1.50	I	-	0.0354	-	0.90
D	0.0177	0.0236	0.45	0.60	J	-	0.0315	-	0.80
E	0.2520	0.2677	6.40	6.80	K	0.2047	0.2165	5.20	5.50
F	0.2125	0.2283	5.40	5.80	L	0.0551	0.0630	1.40	1.60

- Notes:
- 1.Dimension and tolerance based on our Spec. dated May. 05,1996.
 - 2.Controlling dimension: millimeters.
 - 3.Maximum lead thickness includes lead finish thickness, and minimum lead thickness is the minimum thickness of base material.
 - 4.If there is any question with packing specification or packing method, please contact your local HSMC sales office.

Material:

- Lead: 42 Alloy; solder plating
- Mold Compound: Epoxy resin family, flammability solid burning class: UL94V-0

Important Notice:

- All rights are reserved. Reproduction in whole or in part is prohibited without the prior written approval of HSMC.
- HSMC reserves the right to make changes to its products without notice.
- **HSMC semiconductor products are not warranted to be suitable for use in Life-Support Applications, or systems.**
- HSMC assumes no liability for any consequence of customer product design, infringement of patents, or application assistance.

Head Office And Factory:

- **Head Office** (Hi-Sincerity Microelectronics Corp.): 10F.,No. 61, Sec. 2, Chung-Shan N. Rd. Taipei Taiwan R.O.C.
 Tel: 886-2-25212056 Fax: 886-2-25632712, 25368454
- **Factory 1:** No. 38, Kuang Fu S. Rd., Fu-Kou Hsin-Chu Industrial Park Hsin-Chu Taiwan. R.O.C
 Tel: 886-3-5983621~5 Fax: 886-3-5982931