

HL6339G/42G

633nm Lasing Laser Diode

HITACHI

ADE-208-1434A (Z)

Rev.1
Apr. 2002

Description

The HL6339G/42G is 0.63 μm band AlGaInP laser diode with a multi-quantum well (MQW) structure. Lasing wavelength of this laser is nearly equal to the wavelength of He-Ne gas laser. They are suitable as light sources for laser levelers, laser scanners and optical equipment for measurement.

Application

- Measurement
- Laser analysis systems
- Laser scanner

Features

- Optical output power : 5 mW (CW)
- Visible light output : 633 nm Typ (nearly equal to He-Ne gas laser)
- Low operating current : 55 mA Typ
- Low operating voltage : 2.3 V Typ
- TM mode oscillation

Package Type
• HL6339G/42G: G2

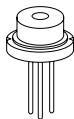

Internal Circuit

• HL6339G

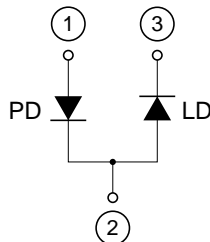

Internal Circuit

• HL6342G

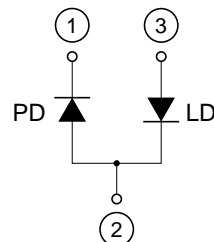

Absolute Maximum Ratings $(T_c = 25^\circ\text{C})$

Item	Symbol	Value	Unit
Optical output power	P_o	5	mW
LD reverse voltage	$V_{R(LD)}$	2	V
PD reverse voltage	$V_{R(PD)}$	30	V
Operating temperature	T_{opr}	-10 to +40	$^\circ\text{C}$
Storage temperature	T_{stg}	-40 to +85	$^\circ\text{C}$

Optical and Electrical Characteristics $(T_c = 25^\circ\text{C})$

Item	Symbol	Min	Typ	Max	Unit	Test Condition
Optical output power	P_o	5	—	—	mW	Kink free
Threshold current	I_{th}	—	45	60	mA	
Operating current	I_{OP}	—	55	70	mA	$P_o = 5 \text{ mW}$
Operating voltage	V_{OP}	—	2.3	2.7	V	$P_o = 5 \text{ mW}$
Slope efficiency	η_s	0.40	0.65	0.90	mW/mA	$3 \text{ (mW)} / (I_{(4\text{mW})} - I_{(1\text{mW})})$
Lasing wavelength	λ_p	630	633	635	nm	$P_o = 5 \text{ mW}$
Beam divergence parallel to the junction	$\theta_{//}$	6	8	11	deg.	$P_o = 5 \text{ mW}$
Beam divergence perpendicular to the junction	θ_{\perp}	25	30	35	deg.	$P_o = 5 \text{ mW}$
Monitor current	I_s	0.04	0.08	0.14	mA	$P_o = 5 \text{ mW}, V_{R(PD)} = 5 \text{ V}$

Typical Characteristic Curves

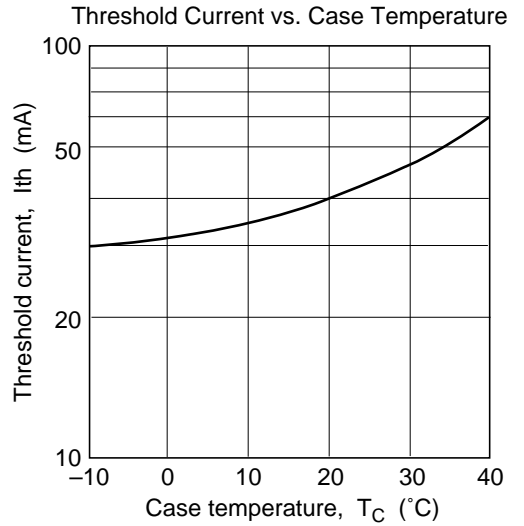
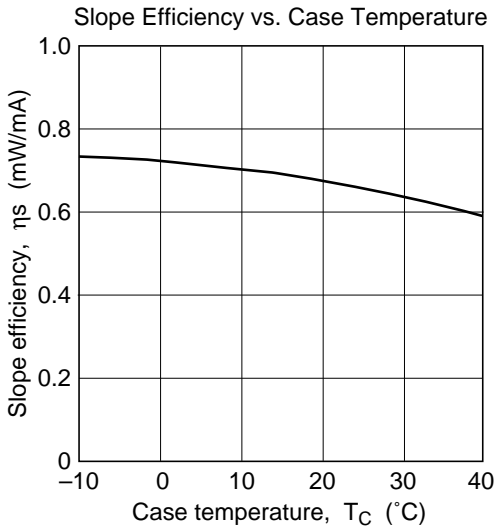
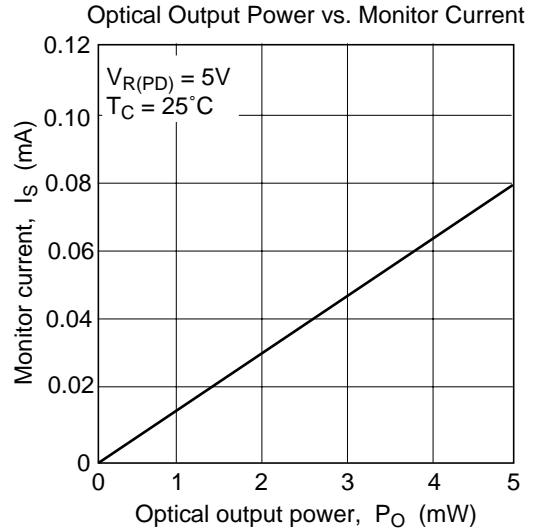
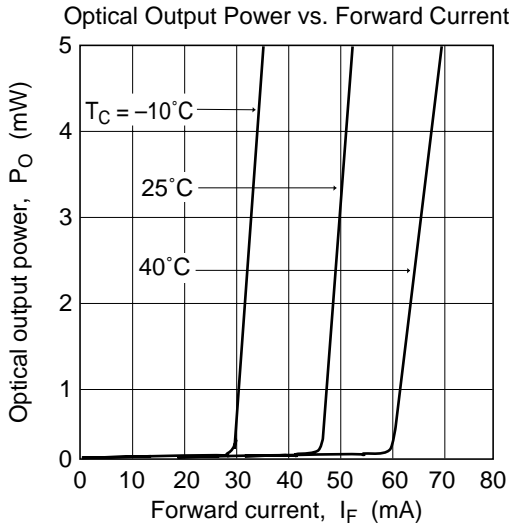

Typical Characteristic Curves (cont)

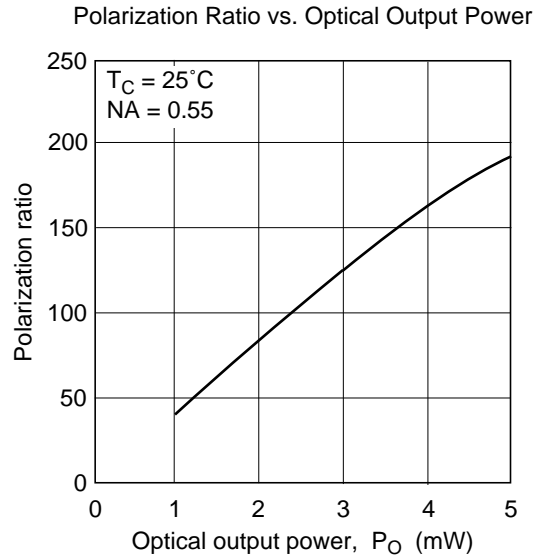
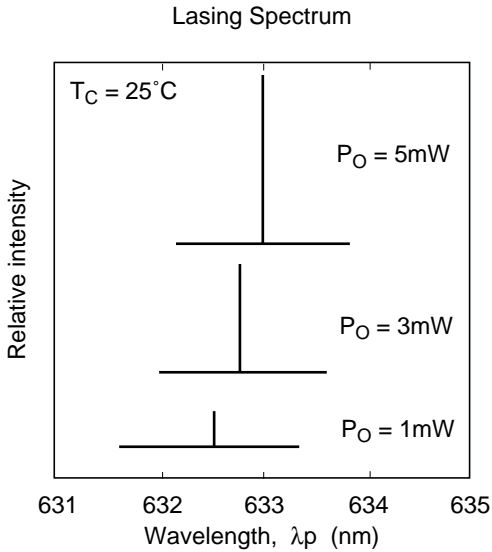
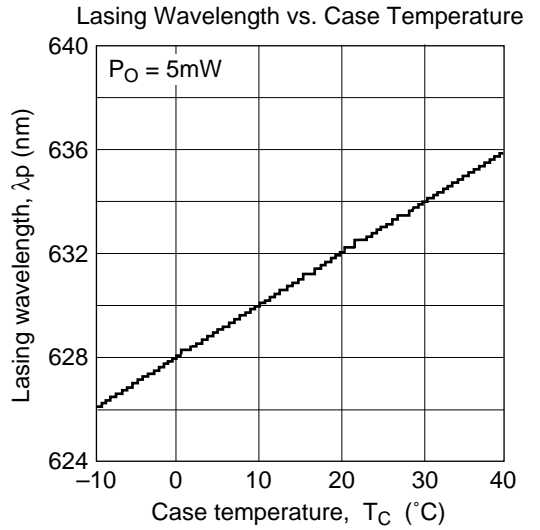
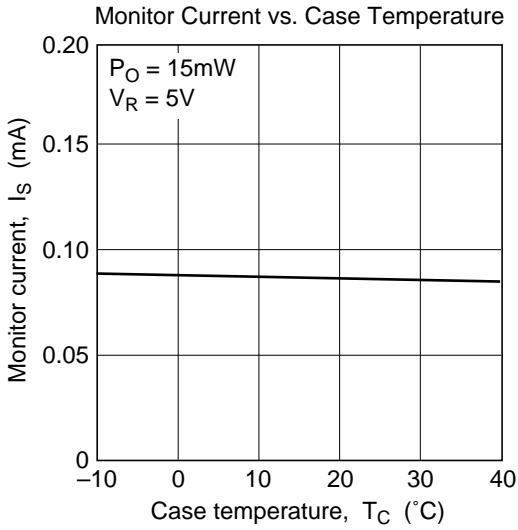

Typical Characteristic Curves (cont)

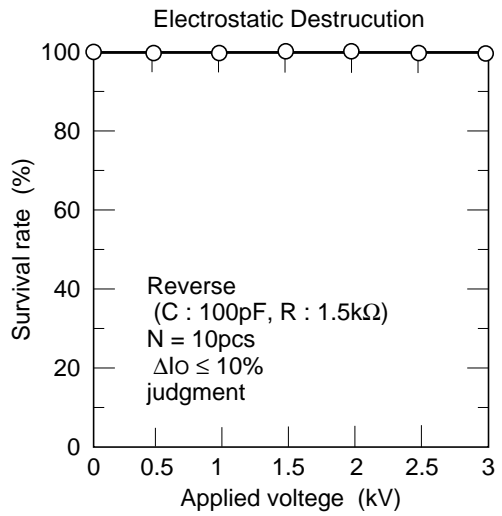
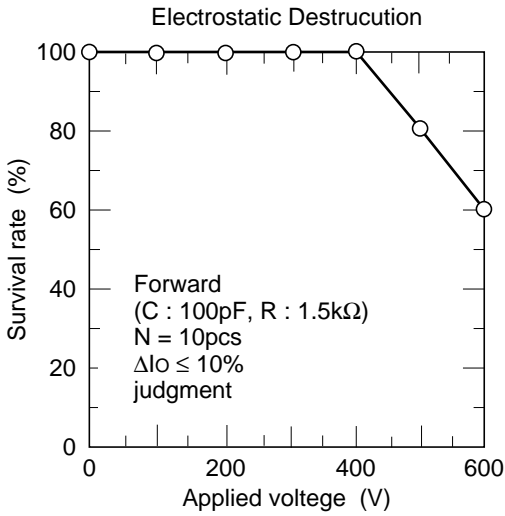
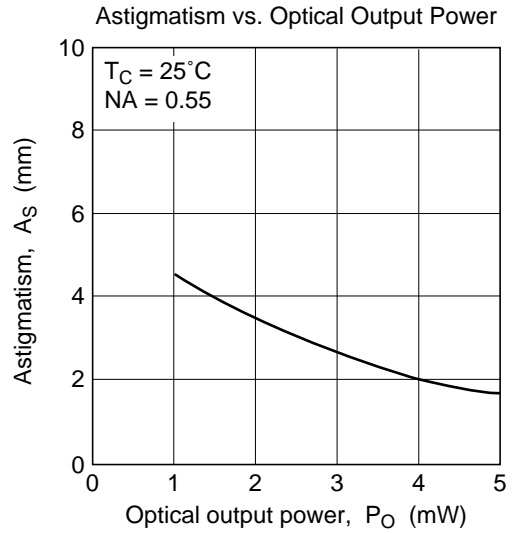
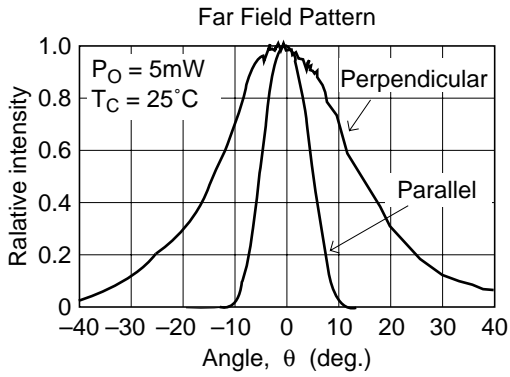

Package Dimensions

As of January, 2002
Unit: mm

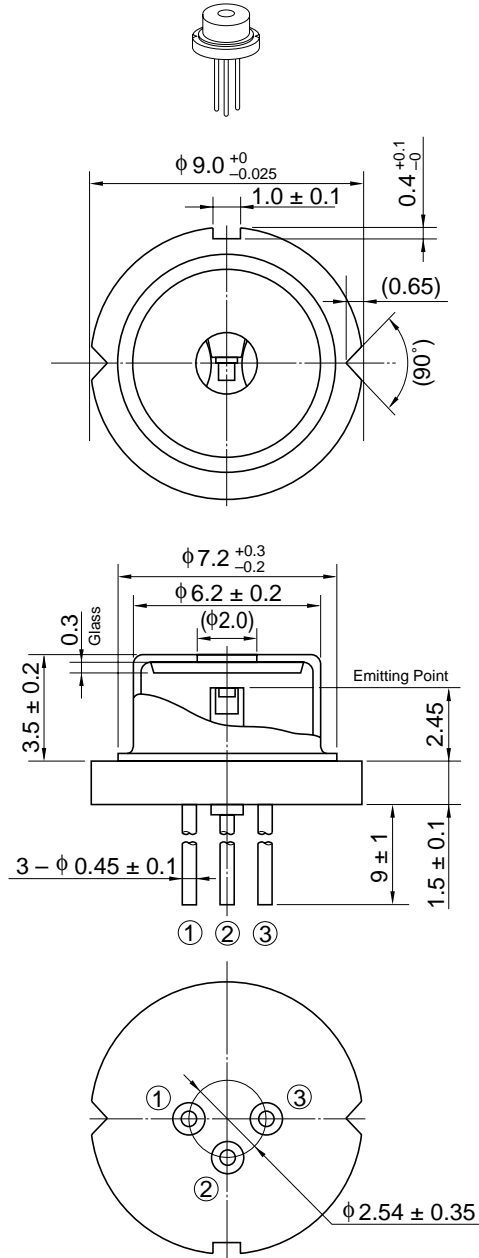

Hitachi Code	LD/G2
JEDEC	—
JEITA	—
Mass (reference value)	1.1 g

Disclaimer

1. Hitachi neither warrants nor grants licenses of any rights of Hitachi's or any third party's patent, copyright, trademark, or other intellectual property rights for information contained in this document. Hitachi bears no responsibility for problems that may arise with third party's rights, including intellectual property rights, in connection with use of the information contained in this document.
2. Products and product specifications may be subject to change without notice. Confirm that you have received the latest product standards or specifications before final design, purchase or use.
3. Hitachi makes every attempt to ensure that its products are of high quality and reliability. However, contact Hitachi's sales office before using the product in an application that demands especially high quality and reliability or where its failure or malfunction may directly threaten human life or cause risk of bodily injury, such as aerospace, aeronautics, nuclear power, combustion control, transportation, traffic, safety equipment or medical equipment for life support.
4. Design your application so that the product is used within the ranges guaranteed by Hitachi particularly for maximum rating, operating supply voltage range, heat radiation characteristics, installation conditions and other characteristics. Hitachi bears no responsibility for failure or damage when used beyond the guaranteed ranges. Even within the guaranteed ranges, consider normally foreseeable failure rates or failure modes in semiconductor devices and employ systemic measures such as fail-safes, so that the equipment incorporating Hitachi product does not cause bodily injury, fire or other consequential damage due to operation of the Hitachi product.
5. This product is not designed to be radiation resistant.
6. No one is permitted to reproduce or duplicate, in any form, the whole or part of this document without written approval from Hitachi.
7. Contact Hitachi's sales office for any questions regarding this document or Hitachi semiconductor products.

1. The laser light is harmful to human body especially to eye no matter what directly or indirectly. The laser beam shall be observed or adjusted through infrared camera or equivalent.

Sales Offices

HITACHI

Hitachi, Ltd.

Semiconductor & Integrated Circuits
Nippon Bldg., 2-6-2, Ohte-machi, Chiyoda-ku, Tokyo 100-0004, Japan
Tel: (03) 3270-2111 Fax: (03) 3270-5109

URL <http://www.hitachisemiconductor.com/>

For further information write to:

Hitachi Semiconductor (America) Inc. 179 East Tasman Drive San Jose, CA 95134 Tel: <1> (408) 433-1990 Fax: <1> (408) 433-0223	Hitachi Europe Ltd. Electronic Components Group Whitebrook Park Lower Cookham Road Maidenhead Berkshire SL6 8YA, United Kingdom Tel: <44> (1628) 585000 Fax: <44> (1628) 585200
---	--

Hitachi Asia Ltd. Hitachi Tower 16 Collyer Quay #20-00 Singapore 049318 Tel: <65>-538-6533/538-8577 Fax: <65>-538-6933/538-3877 URL: http://semiconductor.hitachi.com.sg
--

Hitachi Asia (Hong Kong) Ltd. Group III (Electronic Components) 7/F., North Tower World Finance Centre, Harbour City, Canton Road Tsim Sha Tsui, Kowloon Hong Kong Tel: <852>-(2)-735-9218 Fax: <852>-(2)-730-0281 URL: http://semiconductor.hitachi.com.hk

Hitachi Europe GmbH Electronic Components Group Dornacher Straße 3 D-85622 Feldkirchen Postfach 201, D-85619 Feldkirchen Germany Tel: <49> (89) 9 9180-0 Fax: <49> (89) 9 29 30 00

Hitachi Asia Ltd. (Taipei Branch Office) 4/F, No. 167, Tun Hwa North Road Hung-Kuo Building Taipei (105), Taiwan Tel: <886>-(2)-2718-3666 Fax: <886>-(2)-2718-8180 Telex: 23222 HAS-TP URL: http://www.hitachi.com.tw

Copyright © Hitachi, Ltd., 2001. All rights reserved. Printed in Japan.
Colophon 5.0