

HLC1395

Reflective Sensor

FEATURES

- Side-looking plastic package
- Phototransistor output
- IR emitter and phototransistor detector in a single package
- Low profile for design flexibility
- Designed for short distance detection
- High sensitivity
- Unfocused for sensing diffused surfaces

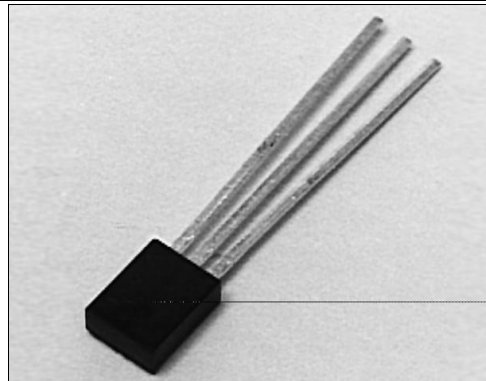

INFRA-58.TIF

DESCRIPTION

The HLC1395 is a miniature infrared sensor designed to sense reflective objects at short distances. Both the GaAs IRED and the NPN phototransistor are mounted side-by-side in a single black plastic package with an integral barrier to minimize crosstalk. The sensor is configured with the IRED cathode and the phototransistor emitter connected to a common lead.



The housing consists of an opaque polysulfone outer shell with transfer-molded, IR-transmissive epoxy encapsulant. Housings are soluble in chlorinated hydrocarbons and ketones. Recommended cleaning agents are methanol and isopropanol.

OUTLINE DIMENSIONS in inches (mm)

Tolerance 3 plc decimals ±0.010(0.25)
2 plc decimals ±0.030(0.76)

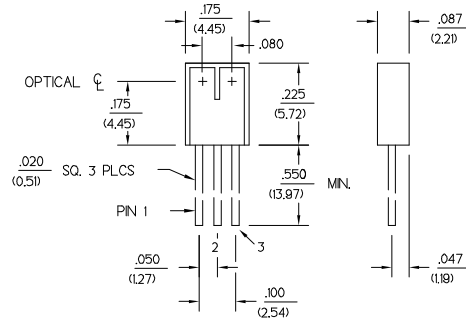

DIM_029.cdr

HLC1395

Reflective Sensor

ELECTRICAL CHARACTERISTICS (25°C unless otherwise noted)

| PARAMETER | SYMBOL | MIN | TYP | MAX | UNITS | TEST CONDITIONS |
|--------------------------------------|---------------|------|-----|-----|---------------|--|
| IR EMITTER | | | | | | |
| Forward Voltage | V_F | | 1.6 | | V | $I_F=20\text{ mA}$ |
| Reverse Current | I_R | | 10 | | μA | $V_R=3\text{ V}$ |
| DETECTOR | | | | | | |
| Collector-Emitter Breakdown Voltage | $V_{(BR)CEO}$ | 30 | | | V | $I_C=100\ \mu\text{A}$ |
| Emitter-Collector Breakdown Voltage | $V_{(BR)ECO}$ | 5.0 | | | V | $I_E=100\ \mu\text{A}$ |
| Collector Dark Current | I_{CEO} | | 100 | | nA | $V_{CE}=10\text{ V}, I_F=0$ |
| COUPLED CHARACTERISTICS | | | | | | |
| On-State Collector Current | $I_{C(ON)}$ | | | | mA | $V_{CE}=5\text{ V}$ |
| HLC1395-001 | | 0.30 | | | | $I_F=10\text{ mA}$ |
| HLC1395-002 | | 0.60 | | | | (1) |
| Collector-Emitter Saturation Voltage | $V_{CE(SAT)}$ | | 0.5 | | V | $I_C=40\ \mu\text{A}, I_F=10\text{ mA}$ (1) |
| Crosstalk (2) | I_{CX} | | 15 | | μA | $V_{CC}=5\text{ V}, I_F=10\text{ mA}$ |
| Rise And Fall Time | t_r, t_f | | 15 | | μs | $V_{CC}=5\text{ V}, I_C=0.3\text{ mA}$ $R_L=1000\ \Omega$ |

Notes

- Test surface is Eastman Kodak neutral white test card with 90% diffuse reflectance located 0.040 in. (1.0 mm) from the front surface of the device.
- Crosstalk (I_{CX}) is the collector current measured with current to emitter and no reflecting surface.

ABSOLUTE MAXIMUM RATINGS

(25°C Free-Air Temperature unless otherwise noted)

| | |
|-------------------------------|---------------|
| Operating Temperature Range | -40°C to 85°C |
| Storage Temperature Range | -40°C to 85°C |
| Soldering Temperature (5 sec) | 240°C |

IR EMITTER

| | |
|----------------------------|------------|
| Reverse Voltage | 3 V |
| Continuous Forward Current | 50 mA |
| Power Dissipation | 100 mW (1) |

DETECTOR

| | |
|---------------------------|------------|
| Collector-Emitter Voltage | 30 V |
| Emitter-Collector Voltage | 5 V |
| Power Dissipation | 100 mW (1) |
| Collector DC Current | 30 mA |

SCHEMATIC

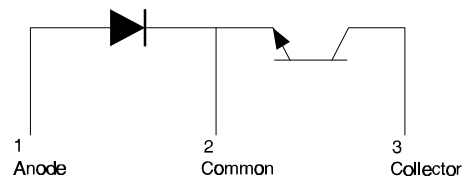

Honeywell reserves the right to make changes in order to improve design and supply the best products possible.

Honeywell

HLC1395

Reflective Sensor

Fig. 1 Normalized Light Current (I_L) vs Distance to Reflective Surface gra_071.ds4

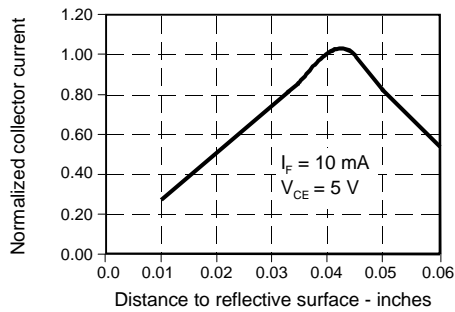

Fig. 2 Normalized Light Current (I_L) vs IRED Forward Current gra_072.ds4

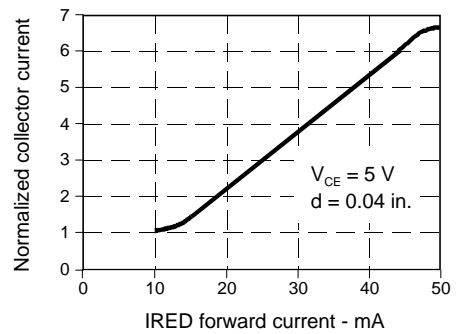

Fig. 3 IRED Forward Bias Characteristics gra_073.ds4

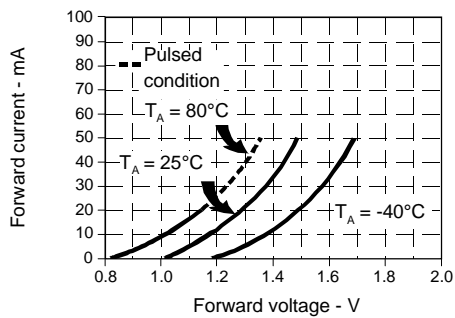

Fig. 4 Non-Saturated Switching Time vs Load Resistance gra_074.ds4

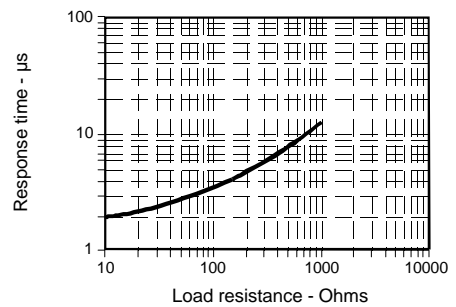

Fig. 5 Dark Current vs Temperature gra_301.cdr

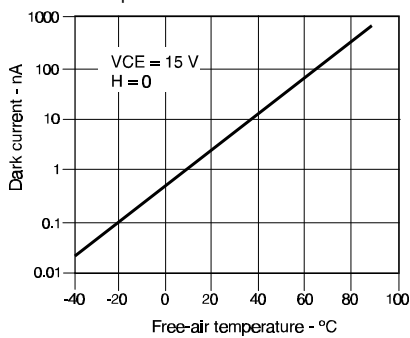
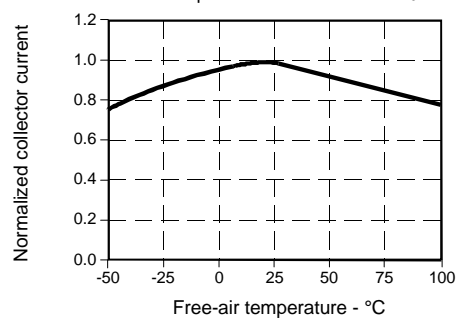

Fig. 6 Collector Current vs Ambient Temperature gra_076.ds4



All Performance Curves Show Typical Values

HLC1395
Reflective Sensor



Honeywell reserves the right to make changes in order to improve design and supply the best products possible.

Honeywell