

HLMP-P106/P156 HLMP-Q102/Q152/Q106/Q156

Subminiature High-Performance Red LED Lamps

Flat-Top Packages

The Broadcom[®] HLMP-Pxxx Series flat-top lamps use an untinted, nondiffused, truncated lens to provide a wide radiation pattern, which is necessary for use in backlighting applications. The flat-top lamps are also ideal for use as emitters in light pipe applications.

Dome Packages

The HLMP-Qxxx Series dome lamps, for use as indicators, use a tinted, diffused lens to provide a wide viewing angle with a high on-off contrast ratio. High-brightness lamps use an untinted, nondiffused lens to provide a high luminous intensity within a narrow radiation pattern.

Lead Configurations

All of these devices are made by encapsulating LED chips on axial lead frames to form molded epoxy subminiature lamp packages. A variety of package configuration options are available. These include special surface-mount lead configurations, gull wing, yoke lead, or Z-bend. Right-angle lead bends at 2.54-mm (0.100-in.) and 5.08-mm (0.200-in.) center spacing are available for through-hole mounting. For additional information, refer to the [Standard SMT and Through-Hole Lead Bend Options for Subminiature LED Lamps Data Sheet](#).

Features

- Subminiature flat-top package
- Ideal for backlighting and light piping applications
- Subminiature dome package
 - Diffused dome for a wide viewing angle
 - Nondiffused dome for high brightness
- Wide range of drive currents: 500 mA to 50 mA
- Ideal for space-limited applications
- Axial leads
- Available with lead configurations for surface-mount and through-hole PC board mounting

Device Selection Guide

Package Description	Viewing Angle $2\theta_{1/2}$	Deep Red Rd = 630 nm	Typical Iv $I_F = 500 \mu A$	Typical Iv $I_F = 20 \text{ mA}$	Package Outline
Domed, Diffused Tinted, Standard Current	35	HLMP-Q102	—	—	B
Domed, Diffused Tinted, Low Current	35	HLMP-Q152	2	—	B
Domed, Nondiffused Untinted, Standard Current	15	HLMP-Q106	—	—	B
Domed, Nondiffused Untinted, Low Current	15	HLMP-Q156	7	—	B
Flat Top, Nondiffused Untinted Standard Current	75	HLMP-P106	—	—	A
Flat Top, Nondiffused Untinted, Low Current	75	HLMP-P156	2	—	A

Ordering Information

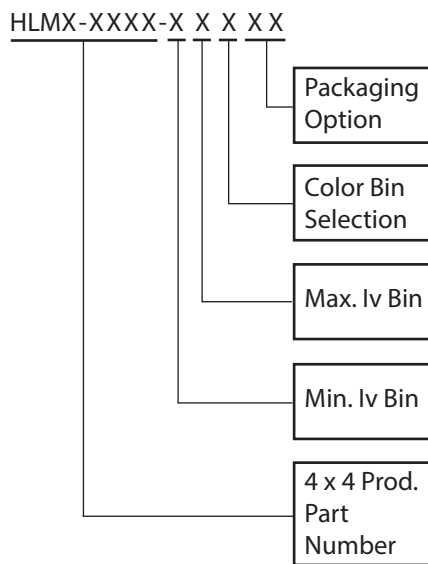

Package Dimensions

A) Flat-Top Lamps

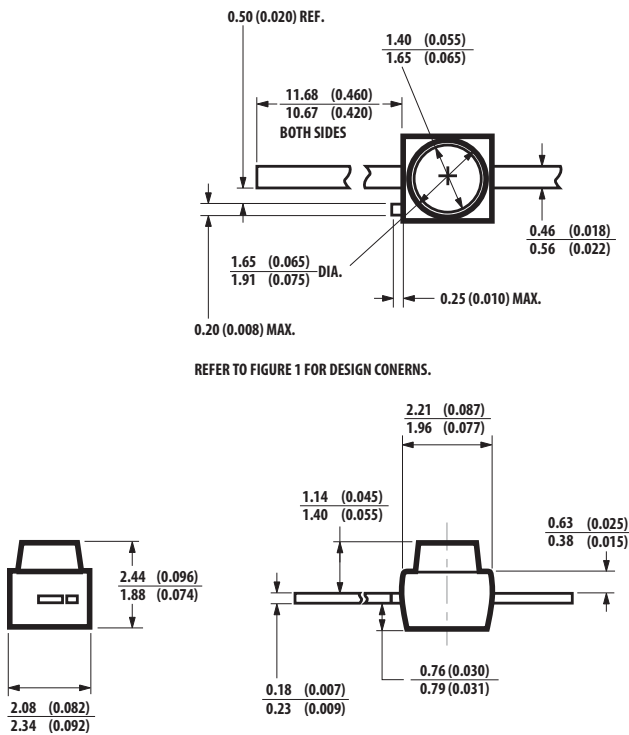

B) Diffused and Nondiffused Dome Lamps

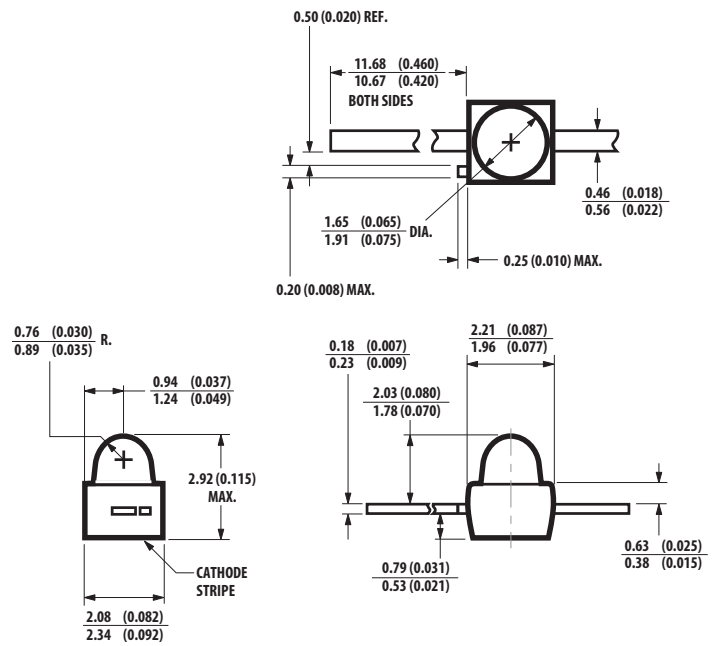

NOTE: All dimensions are in millimeters (inches).

Figure 1: Cathode Stripe Marking



NOTE: All dimensions are in millimeters (inches).

Absolute Maximum Ratings at $T_A = 25^\circ\text{C}$

Parameters	Value
DC Forward Current ^a	50 mA
Peak Forward Current ^b	300 mA
Average Forward Current ^{b, c}	30 mA
Transient Forward Current (10-ms Pulse) ^d	500 mA
Power Dissipation	100 mW ^e
Reverse Voltage	5V
Junction Temperature	110°C
Operating Temperature	-55°C to +100°C
Storage Temperature	-55°C to +100°C
Lead Soldering Temperature (1.6 mm [0.063 in.] from body)	260°C for 5 seconds
Reflow Soldering Temperature	260°C for 20 seconds

- a. Derate linearly as shown in [Figure 6](#).
- b. See [Figure 7](#) to establish pulsed operating conditions.
- c. Maximum I_{AVG} at $f = 1$ kHz, $DF = 10\%$.
- d. The transient peak current is the maximum nonrecurring peak current that the device can withstand without damaging the LED die and wire bonds. It is not recommended that the device be operated at peak currents above the absolute maximum peak forward current.
- e. 120 mW for HLMP-P156-HK0xx and HLMP-Q106-VX0xx.

Optical Characteristics at $T_A = 25^\circ\text{C}$ (Standard Current)

Part Number (Standard Current)	Luminous Intensity I_V (mcd) at 20 mA ^a		Total Flux Peak ϕ_V (mIn) at 20 mA ^b	Peak Wavelength λ_{peak} (nm)	Color, Dominant Wavelength λ_d^c (nm)	Viewing Angle $2\theta^{1/2}$ Degrees ^d	Luminous Efficacy η_V^e (lm/W)
	Min.	Typ.	Typ.	Typ.	Typ.	Typ.	
HLMP-Q106-R00xx	100	400	280	640	630	15	85
HLMP-Q102-N00xx	25	100	—	640	630	35	85
HLMP-Q106-VX0xx	630	—	—	640	630	15	—
HLMP-P106-Q00xx	63	130	280	640	630	75	85

- The luminous intensity, I_V , is measured at the mechanical axis of the lamp package. The actual peak of the spatial radiation pattern may not be aligned with this axis.
- ϕ_V is the total luminous flux output as measured with an integrating sphere.
- The dominant wavelength, λ_d , is derived from the CIE Chromaticity Diagram and represents the color of the device.
- $\theta^{1/2}$ is the off-axis angle where the luminous intensity is $1/2$ the peak intensity.
- Radiant intensity, I_V , in watts/steradian, may be calculated from the equation $I_V = I_V/\eta_V$, where I_V is the luminous intensity in candelas and η_V is the luminous efficacy in lumens/watt.

Optical Characteristics at $T_A = 25^\circ\text{C}$ (Low Current)

Part Number (Low Current)	Luminous Intensity I_V (mcd) at 0.5 mA ^a		Total Flux Peak ϕ_V (mIn) at 0.5 mA ^b	Peak Wavelength λ_{peak} (nm)	Color, Dominant Wavelength λ_d^c (nm)	Viewing Angle $2\theta^{1/2}$ Degrees ^d	Luminous Efficacy η_V^e (lm/W)
	Min.	Typ.	Typ.	Typ.	Typ.	Typ.	
HLMP-Q156-H00xx	2.5	7	10.5	640	630	15	85
HLMP-Q152-G00xx	1.6	2	—	640	630	35	85
HLMP-P156-EG0xx	0.63	2	10.5	640	630	75	85
HLMP-P156-HK0xx	2.5	—	—	640	630	75	—

- The luminous intensity, I_V , is measured at the mechanical axis of the lamp package. The actual peak of the spatial radiation pattern may not be aligned with this axis.
- ϕ_V is the total luminous flux output as measured with an integrating sphere.
- The dominant wavelength, λ_d , is derived from the CIE Chromaticity Diagram and represents the color of the device.
- $\theta^{1/2}$ is the off-axis angle where the luminous intensity is $1/2$ the peak intensity.
- Radiant intensity, I_V , in watts/steradian, may be calculated from the equation $I_V = I_V/\eta_V$, where I_V is the luminous intensity in candelas and η_V is the luminous efficacy in lumens/watt.

Electrical Characteristics at $T_A = 25^\circ\text{C}$ (Standard Current)

Part Number (Standard Current)	Forward Voltage V_F (Volts) at $I_F = 20\text{ mA}$		Reverse Breakdown V_R (Volts) at $I_R = 100\ \mu\text{A}$		Capacitance C (pF) $V_F = 0$, $f = 1\text{ MHz}$	Thermal Resistance $R\theta_{J-PIN}$ ($^\circ\text{C}/\text{W}$)	Speed of Response τ_s (ns) Time Constant e^{-t/τ_s}
	Typ.	Max.	Min.	Typ.	Typ.		Typ.
HLMP-Q106	2.0	2.4	5	25	20	170	45
HLMP-Q106-VX0xx	2.0	2.6	5	25	—	170	—
HLMP-Q102	2.0	2.4	5	25	20	170	45
HLMP-P106	2.0	2.4	5	25	20	170	45

Electrical Characteristics at $T_A = 25^\circ\text{C}$ (Low Current)

Part Number (Low Current)	Forward Voltage V_F (Volts) at $I_F = 0.5\text{ mA}$		Reverse Breakdown V_R (Volts) at $I_R = 100\ \mu\text{A}$		Capacitance C (pF) $V_F = 0$, $f = 1\text{ MHz}$	Thermal Resistance $R\theta_{J-PIN}$ ($^\circ\text{C}/\text{W}$)	Speed of Response τ_s (ns) Time Constant e^{-t/τ_s}
	Typ.	Max.	Min.	Typ.	Typ.		Typ.
HLMP-Q156	1.7	1.9	5	25	20	170	45
HLMP-Q152	1.7	1.9	5	25	20	170	45
HLMP-P156	1.7	1.9	5	25	20	170	45
HLMP-P156-HK0xx	1.7	1.9	5	25	—	170	—

Figure 2: Relative Intensity vs. Wavelength

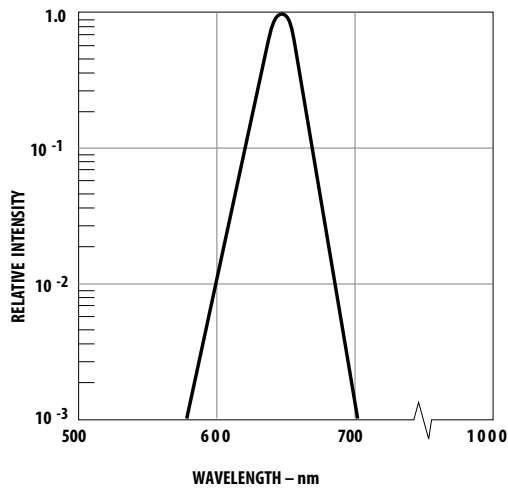

Figure 3: Forward Current vs. Forward Voltage

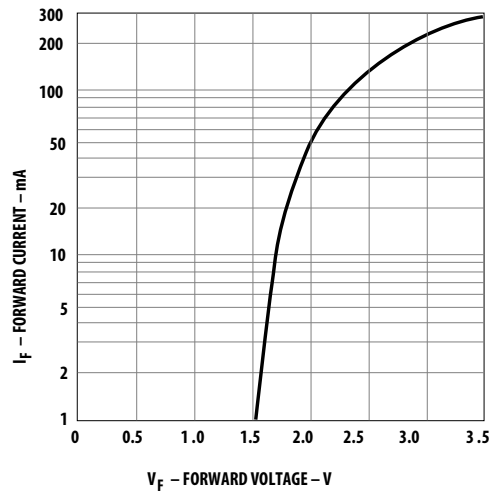

Figure 4: Relative Luminous Intensity vs. DC Forward Current

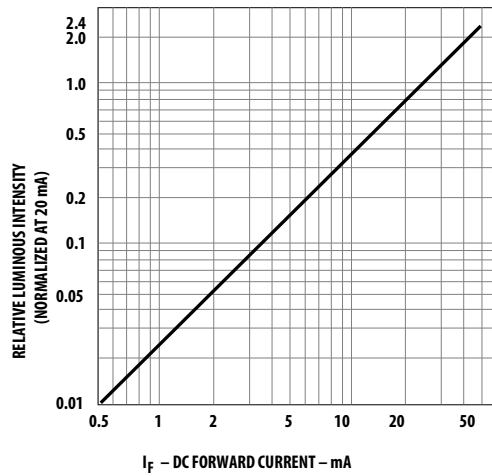

Figure 5: Relative Efficiency vs. Peak Forward Current

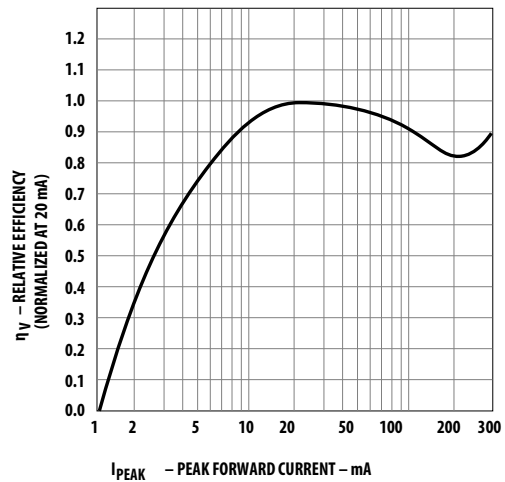

Figure 6: Maximum Forward DC Current vs. Ambient Temperature. Derating Based on $T_{JMAX} = 110^{\circ}\text{C}$.

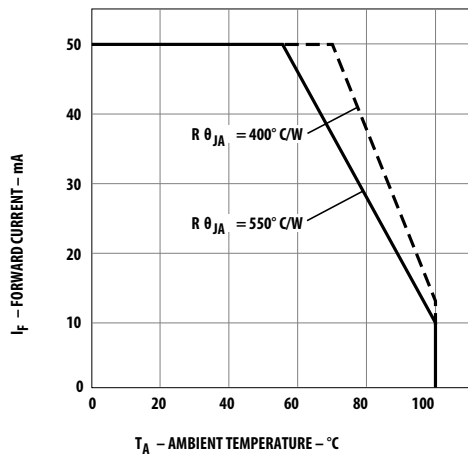

Figure 7: Maximum Average Current vs. Peak Forward Current

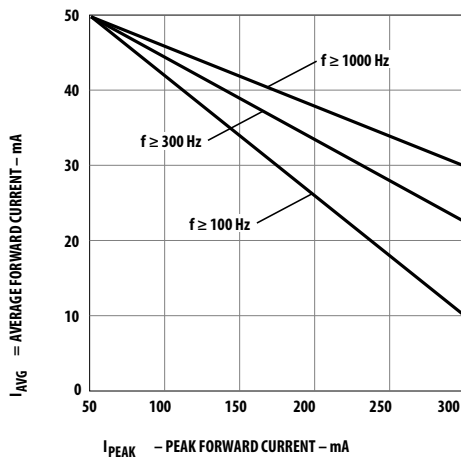

Figure 8: HLMP-Q106/-Q156

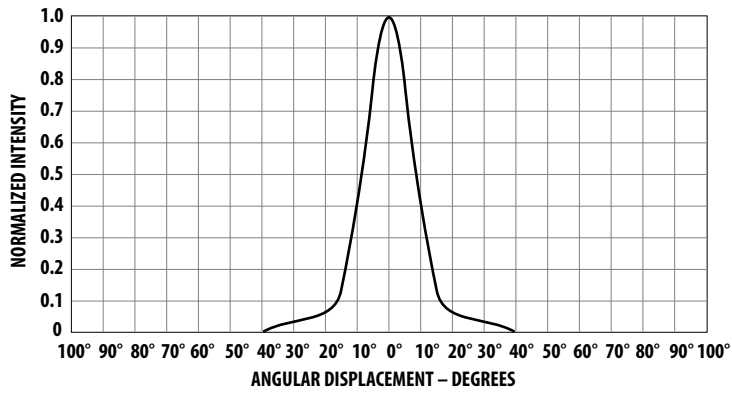

Figure 9: HLMP-Q102/-Q152

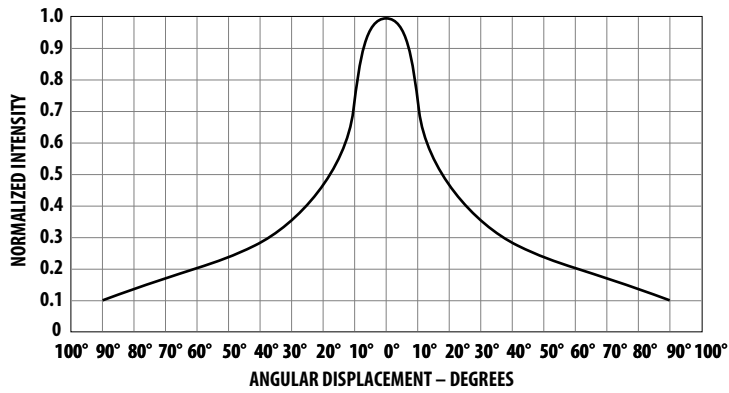
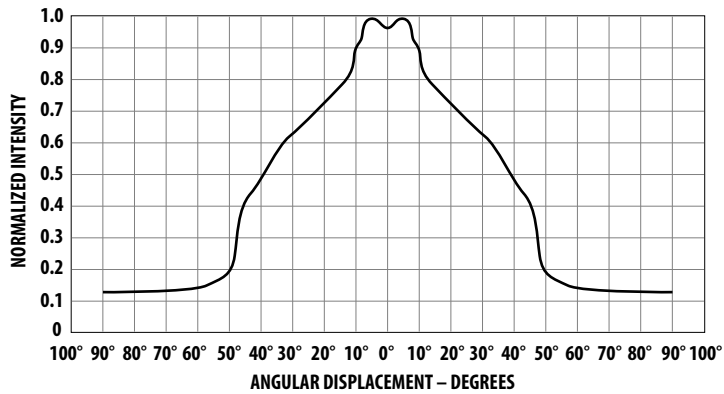

Figure 10: HLMP-P106/-P156



Intensity Bin Limits

Bin	Min.	Max.
E	0.63	1.25
F	1.00	2.00
G	1.60	3.20
H	2.50	5.00
J	4.00	8.00
K	6.30	12.50
L	10.00	20.00
M	16.00	32.00
N	25.00	50.00
P	40.00	80.00
Q	63.00	125.00
R	100.00	200.00
S	160.00	320.00
T	250.00	500.00
U	400.00	800.00
V	630.00	1250.00
W	1000.00	2000.00
X	1600.00	3200.00
Y	2500.00	5000.00

Color Bin Limits

Package	Bin	Min.	Max.
Red	0	Full Distribution	

Mechanical Option

00	Straight Leads, Bulk Packaging, Quantity of 500 Parts
11	Gull Wing Leads, 12-mm Tape on 7-in. Diameter Reel, 1500 Parts per Reel
12	Gull Wing Lead, Bulk Packaging, Quantity of 500 Parts
14	Gull Wing Leads, 12-mm Tape on 13-in. Diameter Reel, 6000 Parts per Reel
21	Yoke Leads, 12-mm Tape on 7-in. Diameter Reel, 1500 Parts per Reel
22	Yoke Leads, Bulk Packaging, Quantity of 500 Parts
24	Yoke Leads, 12-mm Tape on 13-in. Diameter Reel, 6000 Parts per Reel
31	Z-Bend Leads, 12-mm Tape on 7-in. Diameter Reel, 1500 Parts per Reel
32	Z-Bend Leads, Bulk Packaging, Quantity of 500 Parts
34	Z-Bend Leads, 12-mm Tape on 13-in. Diameter Reel, 6000 Parts per Reel

NOTE: All categories are established for classification of products. Products might not be available in all categories. Contact your local Broadcom representative for further clarification and information.

Copyright © 2012–2024 Broadcom. All Rights Reserved. The term “Broadcom” refers to Broadcom Inc. and/or its subsidiaries. For more information, go to www.broadcom.com. All trademarks, trade names, service marks, and logos referenced herein belong to their respective companies.

Broadcom reserves the right to make changes without further notice to any products or data herein to improve reliability, function, or design. Information furnished by Broadcom is believed to be accurate and reliable. However, Broadcom does not assume any liability arising out of the application or use of this information, nor the application or use of any product or circuit described herein, neither does it convey any license under its patent rights nor the rights of others.