

HM2301 Digital-output humidity and temperature sensor

Feature & Application:

- Full range temperature compensated
- Relative humidity and temperature measurement
- Calibrated digital signal
- Outstanding long-term stability
- Extra components not needed
- Long transmission distance
- Low power consumption
- 4 pins packaged and fully interchangeable



Description:

output calibrated digital signal. It utilizes exclusive digital-signal-collecting-technique and humidity sensing technology, assuring its reliability and stability. Its sensing elements is connected with 8-bit single-chip computer.

Every sensor of this model is temperature compensated and calibrated in accurate calibration chamber and the calibration-coefficient is saved in type of programme in OTP memory, when the sensor is detecting, it will cite coefficient from memory.

Small size & low consumption & long transmission distance(20m) enable DHT21 to be suited in all kinds of harsh application occasions.

Single-row packaged with four pins, making the connection very convenient.

Technical Specification:

Model	HM2301
Power supply	3.3-5V DC
Output signal	digital signal via single-bus
Sensing element	Polymer humidity capacitor



Street Address: No.169 Xuesong Road, National&High Tech Zone, Zhengzhou

Zip: 450001

Telephone: 86-371-67169080/70

Fax: 86-371-67169090

Website: <http://www.hwsensor.com>

E-mail: sales@hwsensor.com ; hwsensor@163.com

Measuring range	humidity 0-100%RH; temperature -40 - 80Celsius
Accuracy	humidity +/-3%RH(Max +5%RH); temperature < +/-1Celsius
Resolution or sensitivity	humidity 0.1%RH; temperature 0.1Celsius
Repeatability	humidity +/-1%RH; temperature +/-0.2Celsius
Humidity hysteresis	+/-0.3%RH
Long-term Stability	+/-0.5%RH/year
Sensing period	Average: 2s
Interchangeability	fully interchangeable
Dimensions	size 22*28*5mm

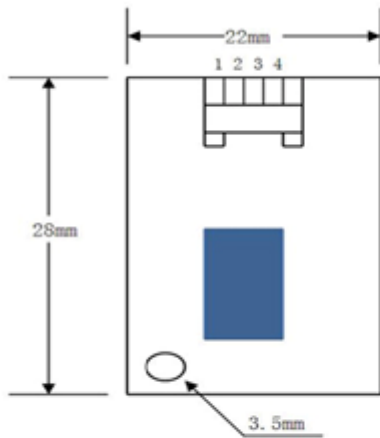
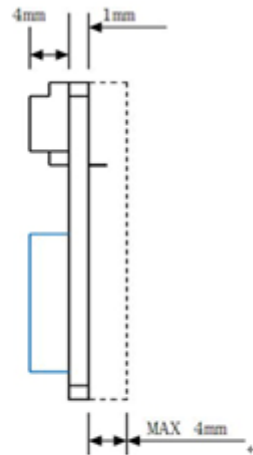
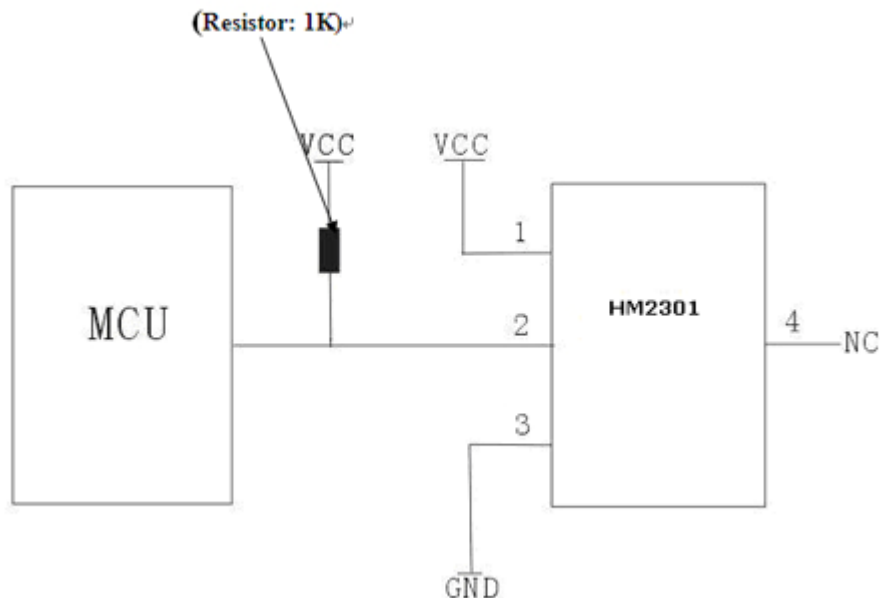
Dimensions: (unit----mm)

Front view

Side elevation
Electrical connection diagram:

Operating specifications:
Street Address: No.169 Xuesong Road,National&High Tech Zone,Zhengzhou

Telephone: 86-371-67169080/70

Website: <http://www.hwsensor.com>

(1) Power and Pins

Power's voltage should be 3.3-5V DC. When power is supplied to sensor, don't send any instruction to the sensor within one second to pass unstable status. One capacitor valued 100nF can be added between VDD and GND for wave filtering.

(2) Communication and signal

Single-bus data is used for communication between MCU and HM2301, it costs 5ms for single one time communication.

Data is comprised of integral and decimal part, the following is the formula for data.

HM2301 send out higher data bit firstly!

DATA=8 bit integral RH data+8 bit decimal RH data+8 bit integral T data+8 bit decimal T data+8 bit check-sum

If the data transmission is right, check-sum should be the last 8 bit of "8 bit integral RH data+8 bit decimal RH data+8 bit integral T data+8 bit decimal T data".

When MCU send start signal, HM2301 change from low-power-consumption-mode to running-mode. When MCU finishes sending the start signal, HM2301 will send response signal of 40-bit data that reflect the relative humidity and temperature information to MCU. Without start signal from MCU, DHT21 will not give response signal to MCU. One start signal for one time's response data that reflect the relative humidity and temperature information from HM2301. HM2301 will change to low-power-consumption-mode when data collecting finish if it don't receive start signal from MCU again.

1) Check bellow picture for overall communication process:

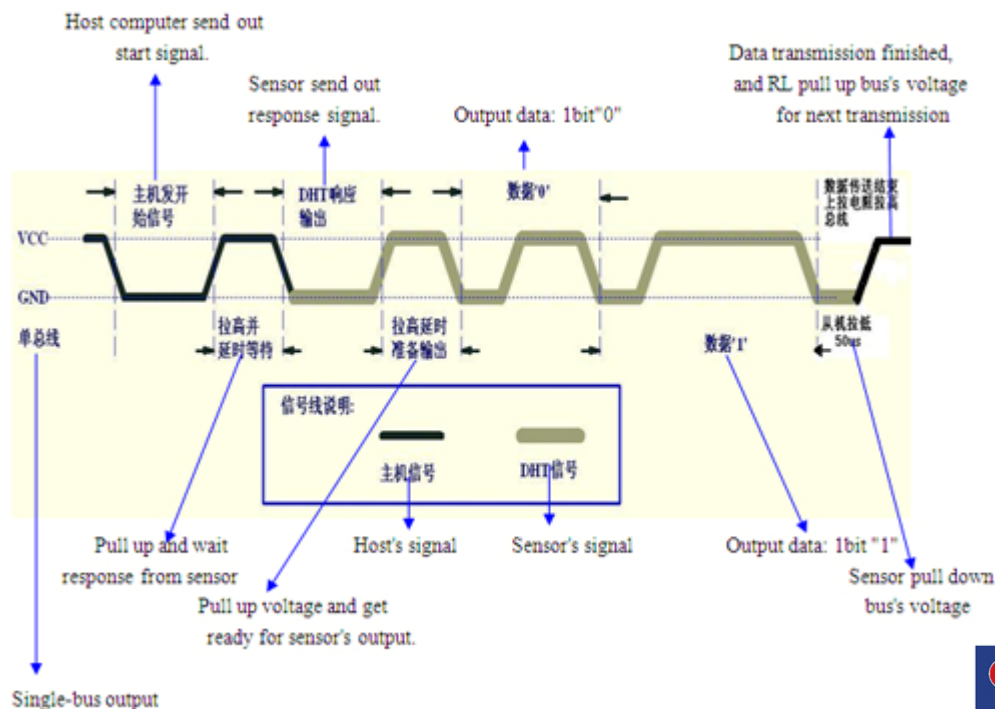

Step 1: MCU send out start signal to HM2301

Data-bus's free status is high voltage level. When communication between MCU and DHT21 begin,

Street Address: No.169 Xuesong Road, National & High Tech Zone, Zhengzhou

Zip: 450001

Telephone: 86-371-67169080/70

Fax: 86-371-67169090

Website: <http://www.hwsensor.com>

E-mail: sales@hwsensor.com ; hwsensor@163.com

program of MCU will transform data-bus's voltage level from high to low level and this process must beyond at least 1ms to ensure HM2301 could detect MCU's signal, then MCU will wait 20-40us for DHT21's response.

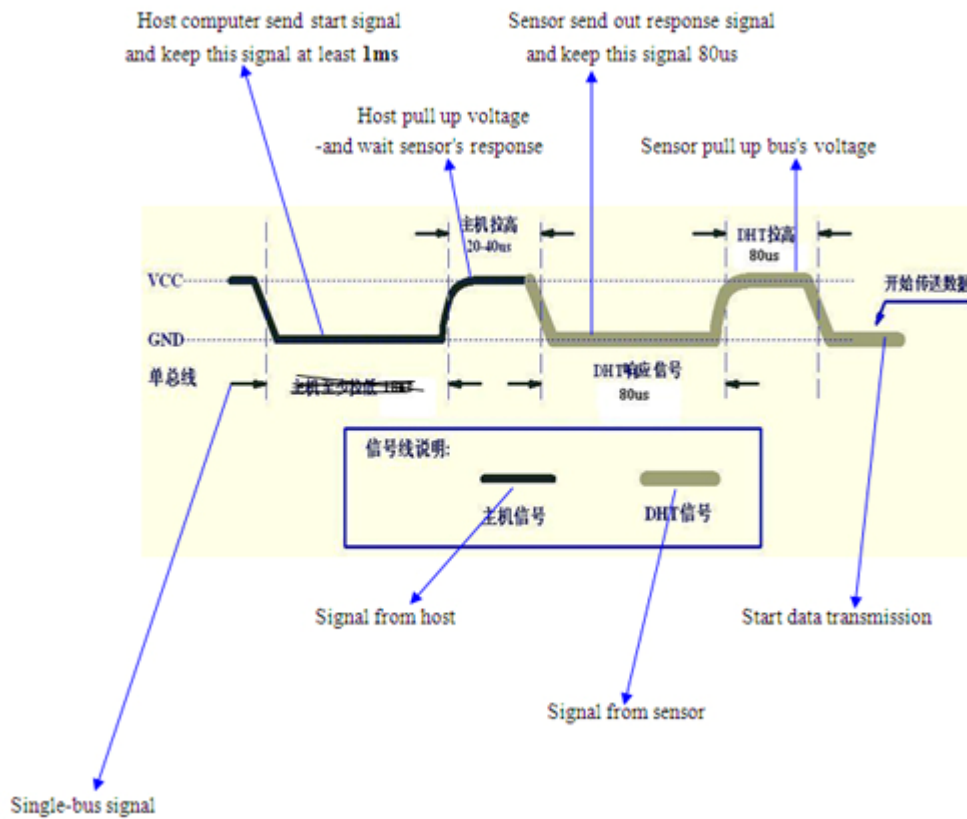

Step 2: HM2301 send response signal to MCU

When HM2301 detect the start signal, DHT21 will send out low-voltage-level signal and this signal last 80us as response signal, then program of DHT21 transform data-bus's voltage level from low to high level and last 80us for HM2301's preparation to send data.

Check bellow picture for step 2:

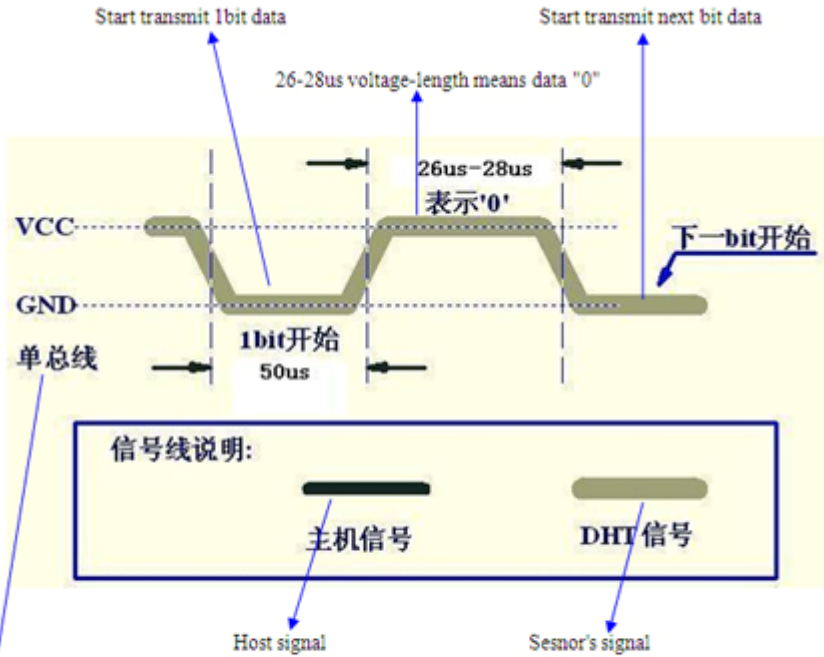

Single-bus signal

Step 3: HM2301 send data to MCU

When HM2301 is sending data to MCU, every bit's transmission begin with low-voltage-level that last 50us, the following high-voltage-level signal's length decide the bit is "1" or "0".

Check bellow picture for step 3:

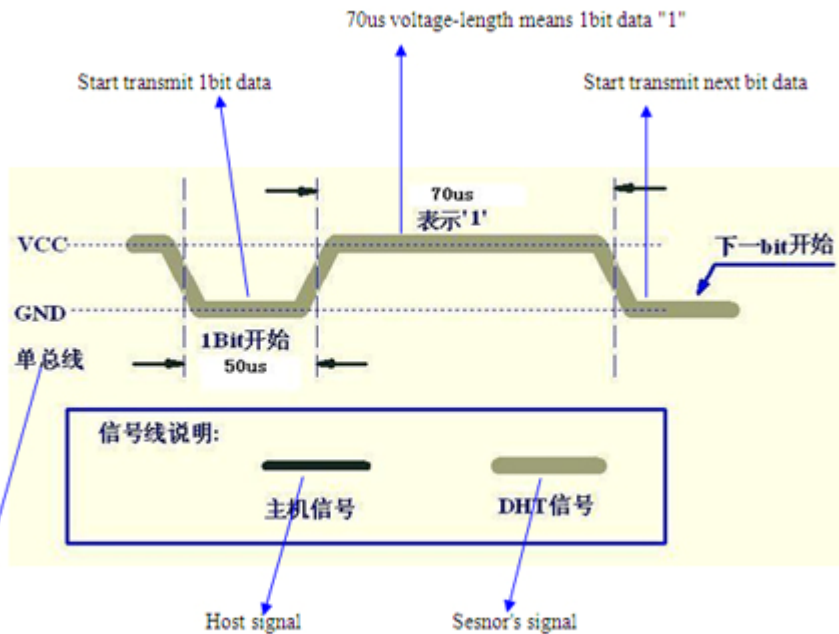

Single-bus signal

If signal from HM2301 is always high-voltage-level, it means HM2301 is not working properly, please check the electrical connection status.

Electrical Characteristics:

Item	Condition	Min	Typical	Max	Unit
Power supply	DC	3.3	5	5.5	V
Current supply	Measuring	1.3	1.5	2.1	mA
	Average	0.5	0.8	1.1	mA
Collecting period	Second	1.7		2	Second

- Collecting period should be : >1.7 second.

Attentions of application:**(1) Operating and storage conditions**

We don't recommend the applying RH-range beyond the range stated in this specification. The DHT21 sensor can recover after working in non-normal operating condition to calibrated status, but will accelerate sensors' aging.

(2) Attentions to chemical materials

Vapor from chemical materials may interfere HM2301's sensitive-elements and debase V's sensitivity.

(3) Disposal when (1) & (2) happens

Step one: Keep the HM2301 sensor at condition of Temperature 50~60 Celsius, humidity <10%RH for 2 hours;

Step two: After step one, keep the DHT21 sensor at condition of Temperature 20~30 Celsius, humidity >70%RH for 5 hours.

(4) Attention to temperature's affection

Relative humidity strongly depend on temperature, that is why we use temperature compensation technology to ensure accurate measurement of RH. But it's still be much better to keep the sensor at same temperature when sensing.

HM2301 should be mounted at the place as far as possible from parts that may cause change to temperature.

(5) Attentions to light

Long time exposure to strong light and ultraviolet may debase HM2301's performance.

(6) Attentions to connection wires

The connection wires' quality will effect communication's quality and distance, high quality shielding-wire is recommended.

(7) Other attentions

- Welding temperature should be bellow 260 Celsius.

- Avoid using the sensor under dew condition.

- Don't use this product in safety or emergency stop devices or any other occasion that failure of HM2301 may cause personal injury.