

## 32768-word × 8-bit High Speed CMOS Static RAM

### Features

- High speed: Fast access time 85/100/120/150 ns (max)
- Low power standby and low power operation
  - Standby: 200  $\mu$ W (typ)/ 10  $\mu$ W (typ) (L-/L-SL-version)
  - Operation: 40 mW (typ) ( $f = 1$  MHz)
- Single 5 V supply
- Completely static RAM: No clock or timing strobe required
- Equal access and cycle time
- Common data input and output, three-state output
- Directly TTL compatible—all inputs and outputs
- Battery back up operation capability (L-/L-SL-version)

### Ordering Information

Type No.	Access time	Package
HM62256P-8	85 ns	600-mil 28-pin plastic DIP (DP-28)
HM62256P-10	100 ns	
HM62256P-12	120 ns	
HM62256P-15	150 ns	
HM62256LP-8	85 ns	
HM62256LP-10	100 ns	
HM62256LP-12	120 ns	
HM62256LP-15	150 ns	
HM62256LP-10SL	100 ns	
HM62256LP-12SL	120 ns	
HM62256LP-15SL	150 ns	

Type No.	Access time	Package
HM62256FP-8T	85 ns	28-pin plastic SOP (FP-28DA)
HM62256FP-10T	100 ns	
HM62256FP-12T	120 ns	
HM62256FP-15T	150 ns	
HM62256LFP-8T	85 ns	
HM62256LFP-10T	100 ns	
HM62256LFP-12T	120 ns	
HM62256LFP-15T	150 ns	
HM62256LFP-10SLT	100 ns	
HM62256LFP-12SLT	120 ns	
HM62256LFP-15SLT	150 ns	

### Pin Arrangement

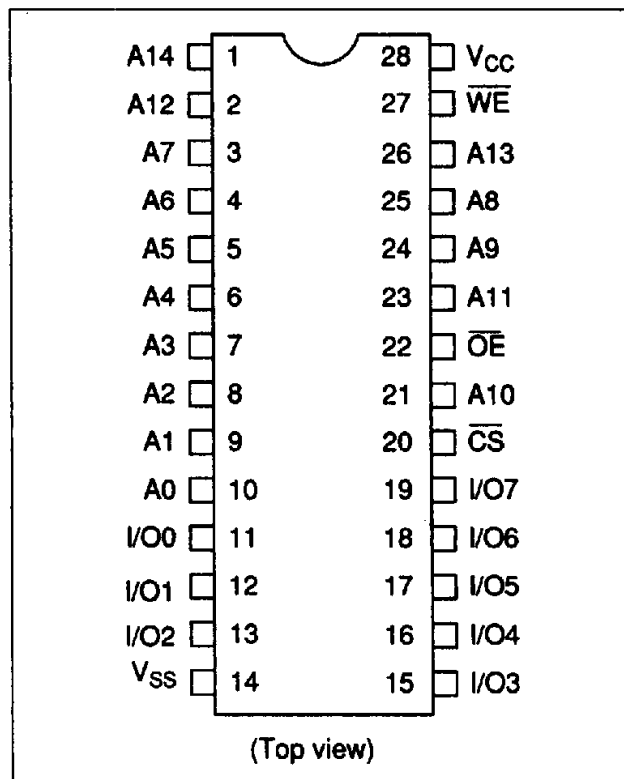

Note: This device is not available for new application.

# HM62256 Series

## Block Diagram

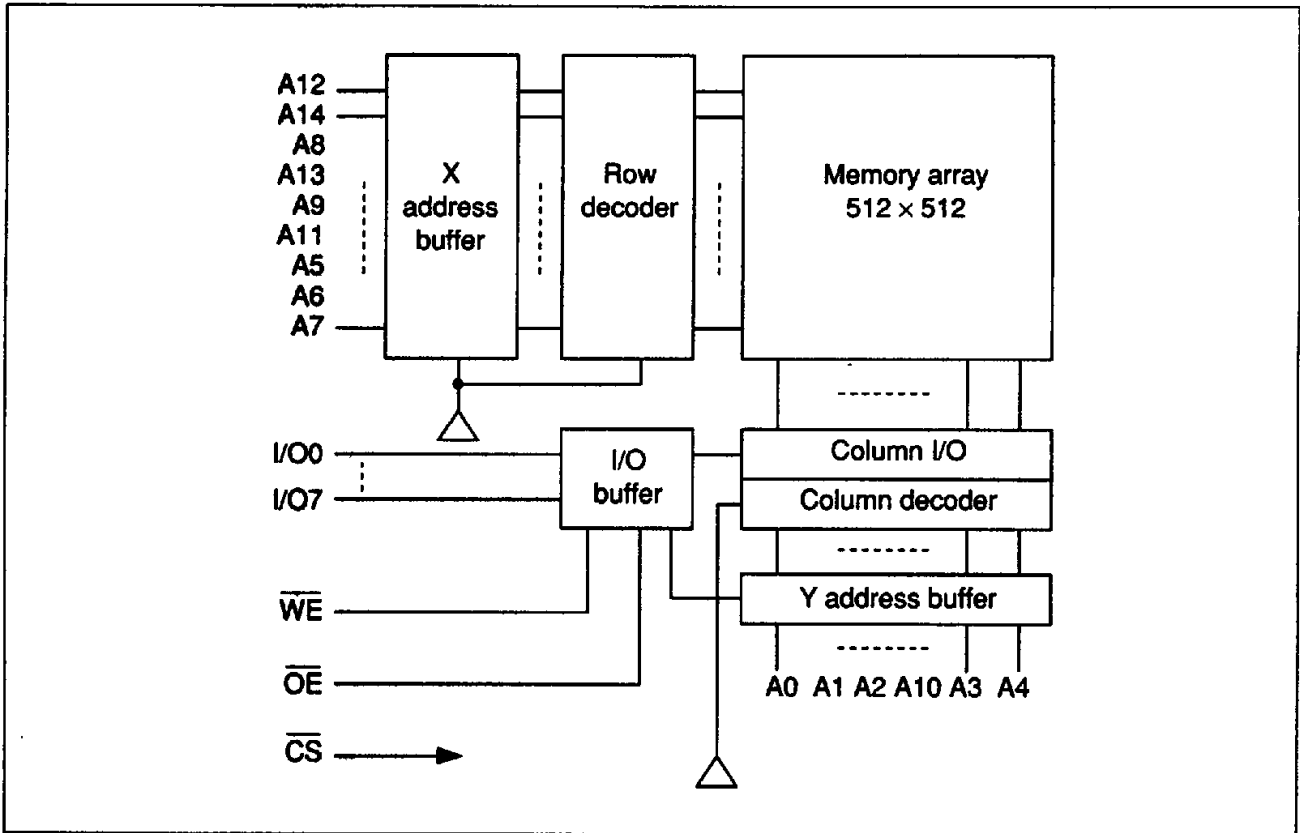

## Truth Table

$\overline{CS}$	$\overline{OE}$	$\overline{WE}$	Mode	$V_{CC}$ current	I/O pin	Reference cycle
H	x	x	Not selected	$I_{SB}, I_{SB1}$	High Z	—
L	L	H	Read	$I_{CC}$	Dout	Read cycle No. 1-3
L	H	L	Write	$I_{CC}$	Din	Write cycle No. 1
L	L	L	Write	$I_{CC}$	Din	Write cycle No. 2

Note: x means H or L

## Absolute Maximum Ratings

Parameter	Symbol	Rating	Unit
Voltage on any pin relative to $V_{SS}$	$V_T$	-0.5* to +7.0	V
Power dissipation	$P_T$	1.0	W
Operating temperature	$T_{opr}$	0 to +70	°C
Storage temperature	$T_{stg}$	-55 to +125	°C
Temperature under bias	$T_{bias}$	-10 to +85	°C

Note: -3.0 V min for pulse width  $\leq 50$  ns

## Recommended DC Operating Conditions ( $T_a = 0$ to +70°C)

Parameter	Symbol	Min	Typ	Max	Unit
Supply voltage	$V_{CC}$	4.5	5.0	5.5	V
	$V_{SS}$	0	0	0	V
Input voltage	$V_{IH}$	2.2	—	6.0	V
	$V_{IL}$	-0.5*	—	0.8	V

Note: -3.0 V min for pulse width  $\leq 50$  ns

## DC Characteristics ( $V_{CC} = 5\text{ V} \pm 10\%$ , $V_{SS} = 0\text{ V}$ , $T_a = 0$ to +70°C)

Parameter	Symbol	Min	Typ <sup>*1</sup>	Max	Unit	Test condition	
Input leakage current	$ I_{LI} $	—	—	2	$\mu\text{A}$	$V_{IN} = V_{SS}$ to $V_{CC}$	
Output leakage current	$ I_{LO} $	—	—	2	$\mu\text{A}$	$\overline{CS} = V_{IH}$ or $\overline{OE} = V_{IH}$ or $\overline{WE} = V_{IL}$ $V_{IO} = V_{SS}$ to $V_{CC}$	
Operating power supply current	$I_{CC}$	—	8	15	mA	$\overline{CS} = V_{IL}$ , $I_{IO} = 0\text{ mA}$	
Average operating power supply current	HM62256-8	$I_{CC1}$	—	50	70	mA	Min. cycle, duty = 100%, $\overline{CS} = V_{IL}$ , $I_{IO} = 0\text{ mA}$
	HM62256-10	—	—	40	70	mA	
	HM62256-12	—	—	35	70	mA	
	HM62256-15	—	—	33	70	mA	
		$I_{CC2}$	—	8	15	mA	$\overline{CS} = V_{IL}$ , $V_{IH} = V_{CC}$ , $V_{IL} = 0\text{V}$ , $I_{IO} = 0\text{ mA}$ $f = 1\text{ MHz}$

## HM62256 Series

### DC Characteristics ( $V_{CC} = 5\text{ V} \pm 10\%$ , $V_{SS} = 0\text{ V}$ , $T_a = 0\text{ to }+70^\circ\text{C}$ ) (cont)

Parameter	Symbol	Min	Typ *1	Max	Unit	Test condition
Standby power supply current	$I_{SB}$	—	0.5	3	mA	$\overline{CS} = V_{IH}$
	$I_{SB1}$	—	0.04	2	mA	$\overline{CS} \geq V_{CC} - 0.2\text{V}$ , $0\text{V} \leq V_{IN}$
	—	—	2*2	100*2	$\mu\text{A}$	
	—	—	2*3	50*3		
Output voltage	$V_{OL}$	—	—	0.4	V	$I_{OL} = 2.1\text{ mA}$
	$V_{OH}$	2.4	—	—	V	$I_{OH} = -1.0\text{ mA}$

- Notes: 1. Typical values are at  $V_{CC} = 5.0\text{ V}$ ,  $T_a = 25^\circ\text{C}$  and specified loading.  
2. These characteristics are guaranteed only for L-version.  
3. These characteristics are guaranteed only for L-SL version.

### Capacitance ( $T_a = 25^\circ\text{C}$ , $f = 1\text{ MHz}$ )

Parameter	Symbol	Typ	Max	Unit	Test Condition
Input capacitance	$C_{IN}$	—	6	pF	$V_{IN} = 0\text{ V}$
Input/output capacitance	$C_{I/O}$	—	8	pF	$V_{I/O} = 0\text{ V}$

Note: These parameters are sampled and not 100% tested.

### AC Characteristics ( $V_{CC} = 5\text{ V} \pm 10\%$ , $T_a = 0\text{ to }+70^\circ\text{C}$ unless otherwise noted)

#### AC Test Conditions:

- Input pulse levels: 0.8 V to 2.4 V
- Input and output timing reference levels: 1.5 V
- Input rise and fall times: 5 ns
- Output load: 1TTL gate and  $C_L = 100\text{ pF}$  (including scope and jig)

## Read Cycle

Parameter	Symbol	HM62256-8		HM62256-10		HM62256-12		HM62256-15		Unit
		Min	Max	Min	Max	Min	Max	Min	Max	
Read cycle time	$t_{RC}$	85	—	100	—	120	—	150	—	ns
Address access time	$t_{AA}$	—	85	—	100	—	120	—	150	ns
Chip select access time	$t_{ACS}$	—	85	—	100	—	120	—	150	ns
Output enable to output valid	$t_{OE}$	—	45	—	50	—	60	—	70	ns
Output hold from address change	$t_{OH}$	5	—	10	—	10	—	10	—	ns
Chip selection to output in low Z	$t_{CLZ}$	10	—	10	—	10	—	10	—	ns
Output enable to output in low Z	$t_{OLZ}$	5	—	5	—	5	—	5	—	ns
Chip deselection to output in high Z	$t_{CHZ}$	0	30	0	35	0	40	0	50	ns
Output disable to output in high Z	$t_{OHZ}$	0	30	0	35	0	40	0	50	ns

## Read Timing Waveform (1)

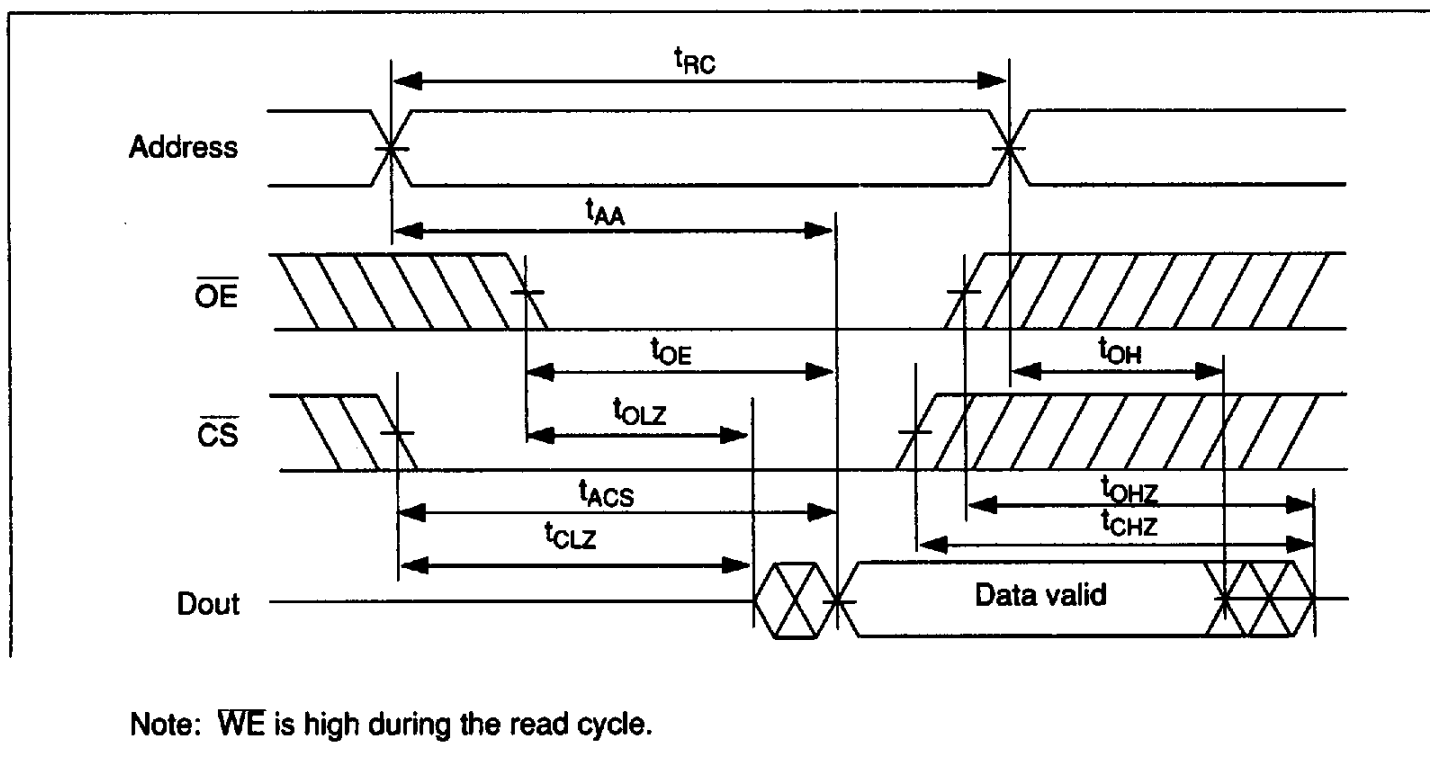

# HM62256 Series

## Read Timing Waveform (2)

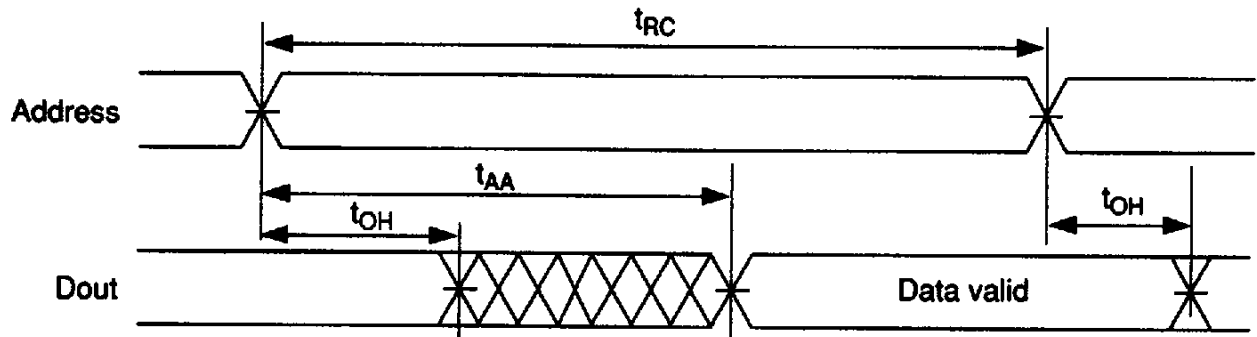

- Notes: 1.  $\overline{WE}$  is high during the read cycle.  
2. Device is continuously selected,  $\overline{CS} = V_{IL}$ .  
3.  $\overline{OE} = V_{IL}$ .

## Read Timing Waveform (3)

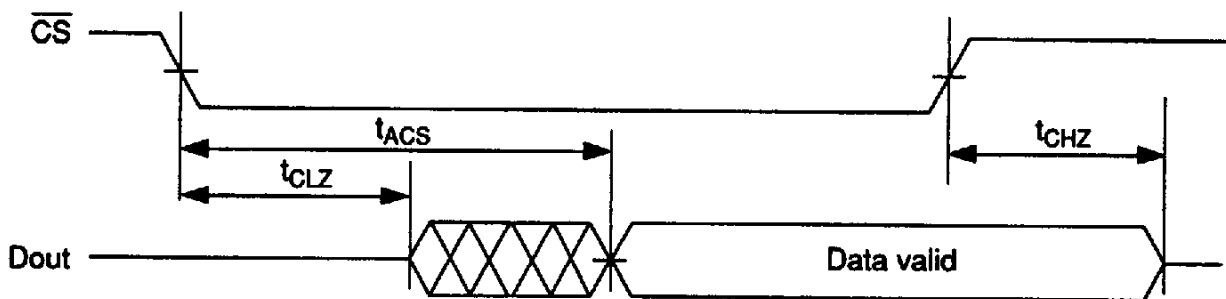

- Notes: 1.  $\overline{WE}$  is high during the read cycle.  
2. Address valid prior to or coincident with  $\overline{CS}$  transition low.  
3.  $\overline{OE} = V_{IL}$ .

## Write Cycle

Parameter	Symbol	HM62256-8		HM62256-10		HM62256-12		HM62256-15		Unit
		Min	Max	Min	Max	Min	Max	Min	Max	
Write cycle time	$t_{WC}$	85	—	100	—	120	—	150	—	ns
Chip selection to end of write	$t_{CW}$	75	—	80	—	85	—	100	—	ns
Address valid to end of write	$t_{AW}$	75	—	80	—	85	—	100	—	ns
Address set up time	$t_{AS}$	0	—	0	—	0	—	0	—	ns
Write pulse width	$t_{WP}$	60	—	60	—	70	—	90	—	ns
Write recovery time	$t_{WR}$	10	—	0	—	0	—	0	—	ns
Write to output in high Z	$t_{WHZ}$	0	30	0	35	0	40	0	50	ns
Data to write time overlap	$t_{DW}$	40	—	40	—	50	—	60	—	ns
Data hold from write time	$t_{DH}$	0	—	0	—	0	—	0	—	ns
Output disable to output in high Z	$t_{OHZ}$	0	30	0	35	0	40	0	50	ns
Output active from end of write	$t_{OW}$	5	—	5	—	5	—	5	—	ns

### Write Timing Waveform (1) ( $\overline{OE}$ Clock)

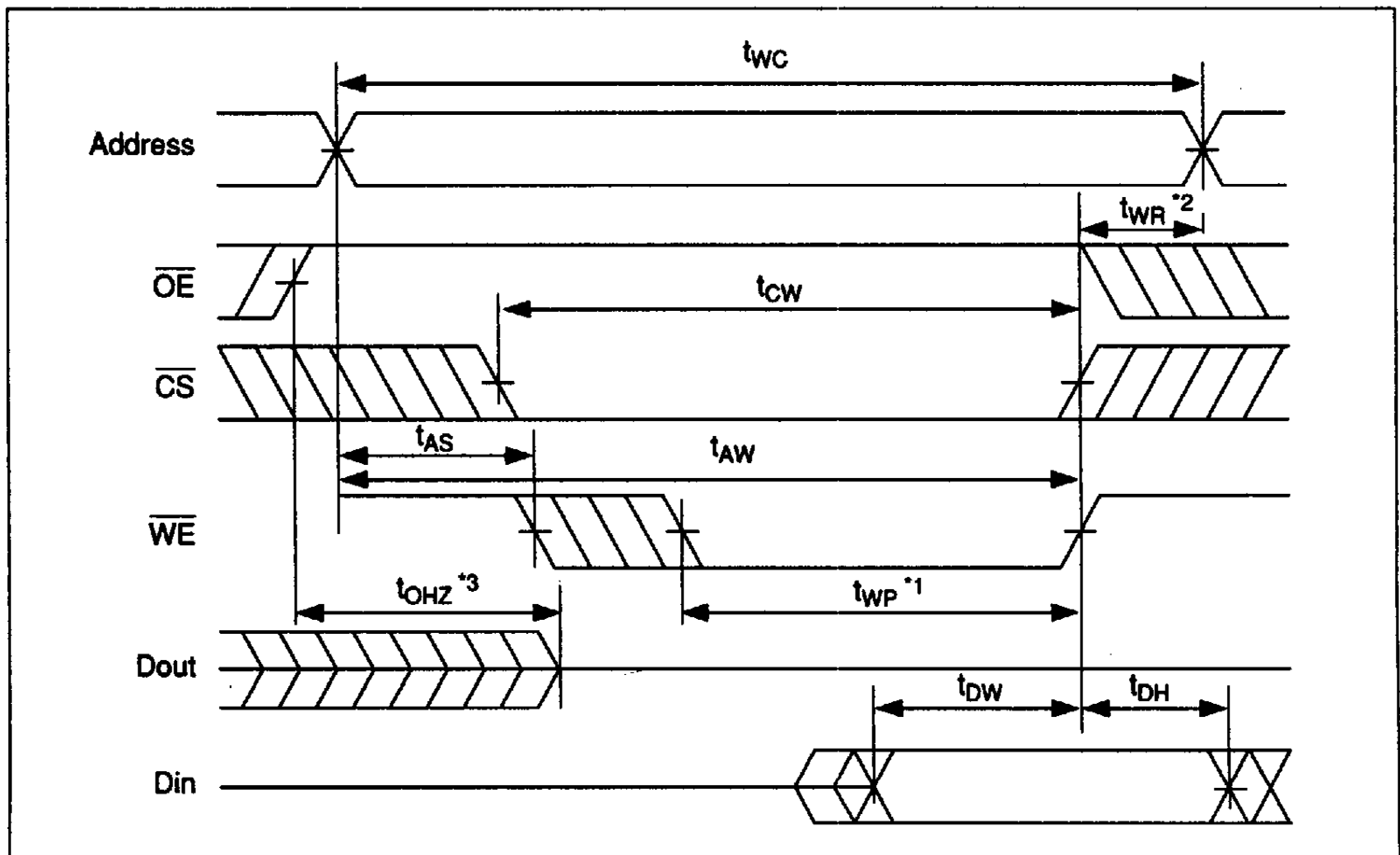

- Notes:
1. A write occurs during the overlap ( $t_{WP}$ ) of a low  $\overline{CS}$  and a low  $\overline{WE}$ .
  2.  $t_{WR}$  is measured from the earlier of  $\overline{CS}$  or  $\overline{WE}$  going high to the end of write cycle.
  3. During this period, I/O pins are in the output state. Out of phase input signals must not be applied.

# HM62256 Series

## Write Timing Waveform (2) ( $\overline{OE}$ Fixed Low)

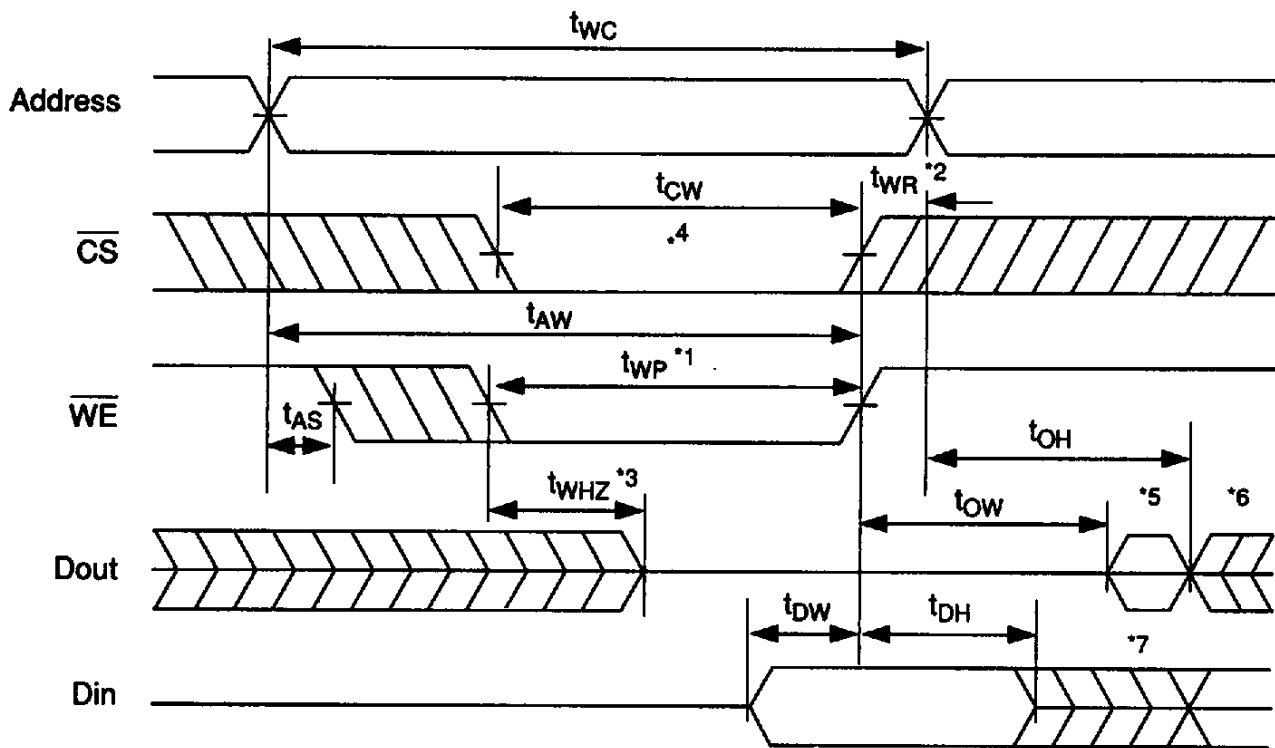

- Notes:
1. A write occurs during the overlap ( $t_{WP}$ ) of a low  $\overline{CS}$  and a low  $\overline{WE}$ .
  2.  $t_{WR}$  is measured from the earlier of  $\overline{CS}$  or  $\overline{WE}$  going high to the end of write cycle.
  3. During this period, I/O pins are in the output state. The input signals out of phase must not be applied.
  4. If the  $\overline{CS}$  low transition occurs simultaneously with the  $\overline{WE}$  low transition or after the  $\overline{WE}$  low transition, outputs remain in a high impedance state.
  5. Dout is in the same phase of written data of this write cycle.
  6. Dout is the read data of next address.
  7. If  $\overline{CS}$  is low during this period, I/O pins are in the output state. Out of phase input signals must not be applied to I/O pins.



**Low  $V_{CC}$  Data Retention Characteristics ( $T_a = 0$  to  $+70^\circ\text{C}$ )**

These characteristics are guaranteed only for L- and L-SL version.

Parameter	Symbol	Test Conditions	Min	Typ	Max	Unit
$V_{CC}$ for data retention	$V_{DR}$	$\overline{CS} \geq V_{CC} - 0.2 \text{ V}$	2.0	—	—	V
Data retention current	$I_{CCDR}$	$V_{CC} = 3.0 \text{ V}, \overline{CS} \geq 2.8 \text{ V}$ $0 \text{ V} \leq V_{IN}$	—	—	$50^{*2}$ $10^{*3}$	$\mu\text{A}$
Chip deselect to data retention time	$t_{CDR}$	See retention waveform	0	—	—	ns
Operation recovery time	$t_R$	See retention waveform	$t_{RC}^{*1}$	—	—	ns

- Notes: 1.  $t_{RC}$  = read cycle time  
 2. These characteristics are guaranteed only for L-version,  $V_{IL} = -0.3 \text{ V}$  min,  $20 \mu\text{A}$  max. at  $T_a = 0$  to  $40^\circ\text{C}$ .  
 3. These characteristics are guaranteed only for L-SL version,  $V_{IL} = -0.3 \text{ V}$  min,  $3 \mu\text{A}$  max. at  $T_a = 0$  to  $40^\circ\text{C}$ .

**Low  $V_{CC}$  Data Retention Waveform**

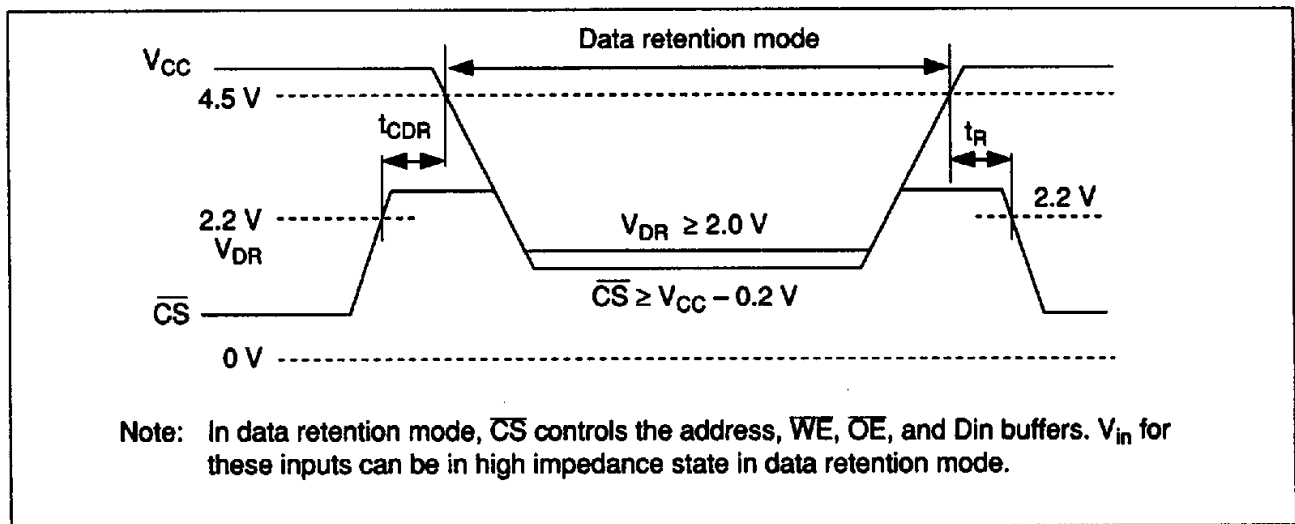

# HM62256 Series

## Characteristic Curves

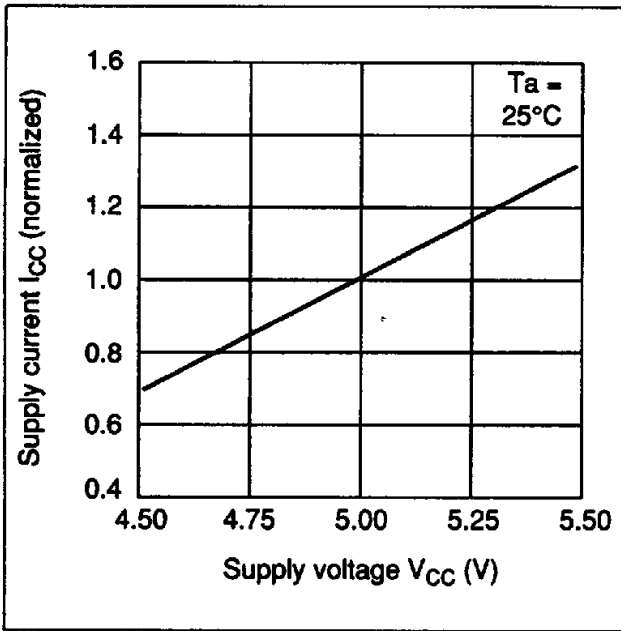

Supply Current vs. Supply Voltage (1)

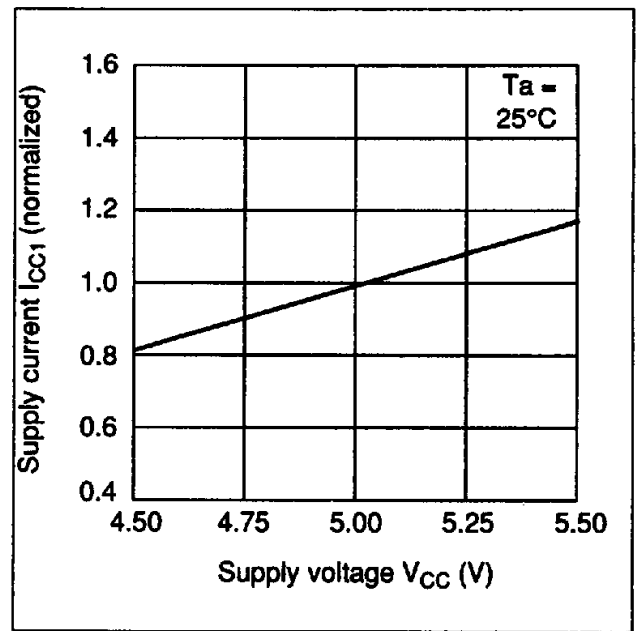

Supply Current vs. Supply Voltage (2)

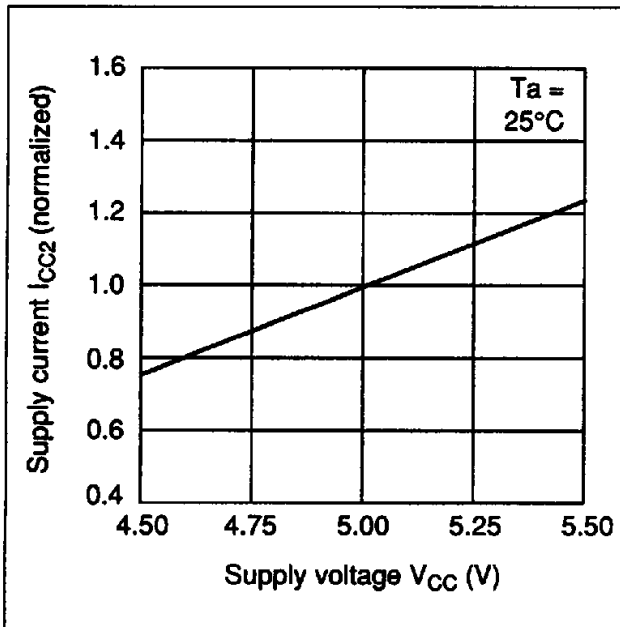

Supply Current vs. Supply Voltage (3)

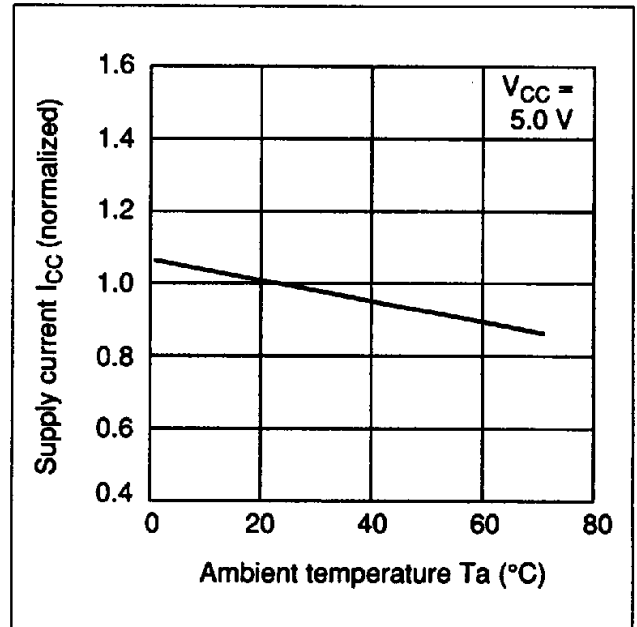

Supply Current vs. Ambient Temperature (1)

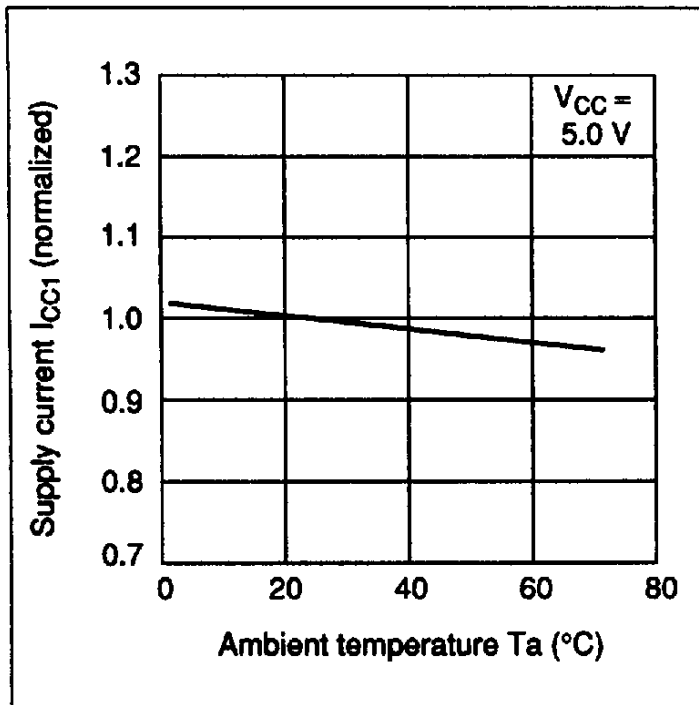

Supply Current vs. Ambient Temperature (2)

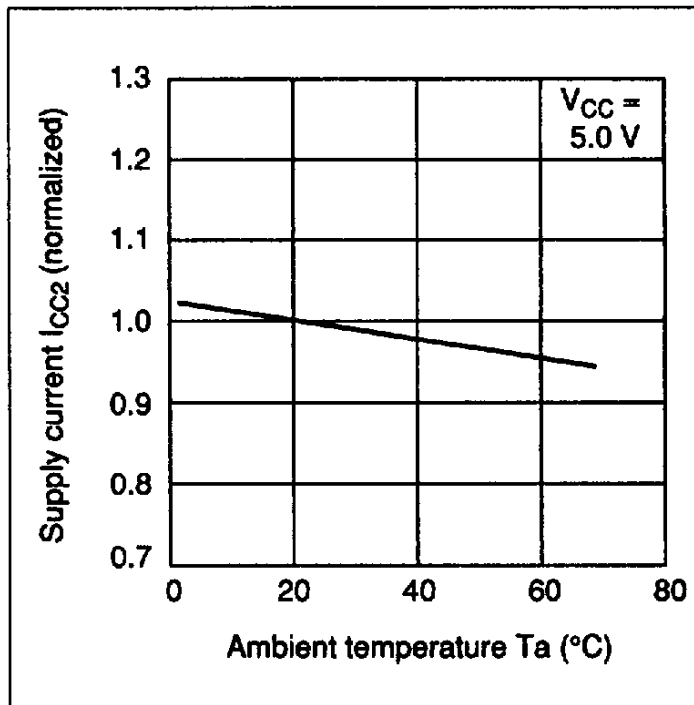

Supply Current vs. Ambient Temperature (3)

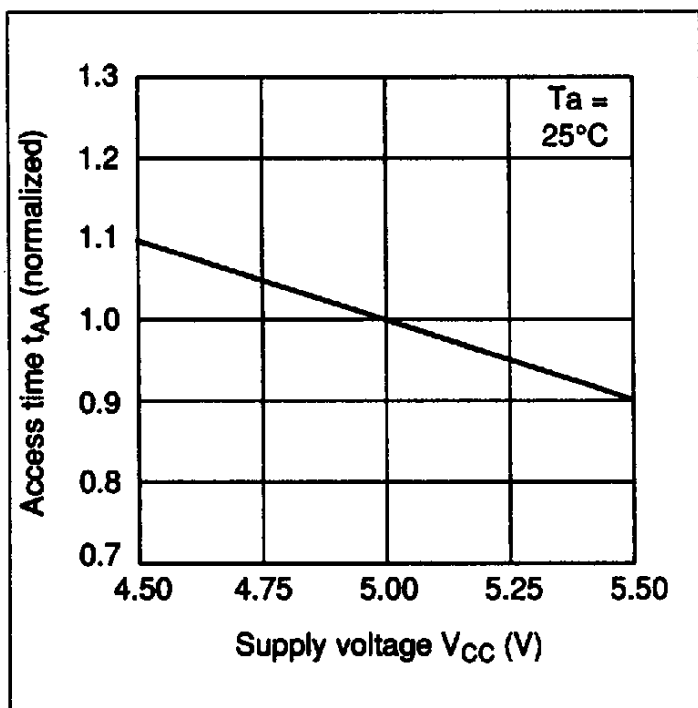

Access Time vs. Supply Voltage

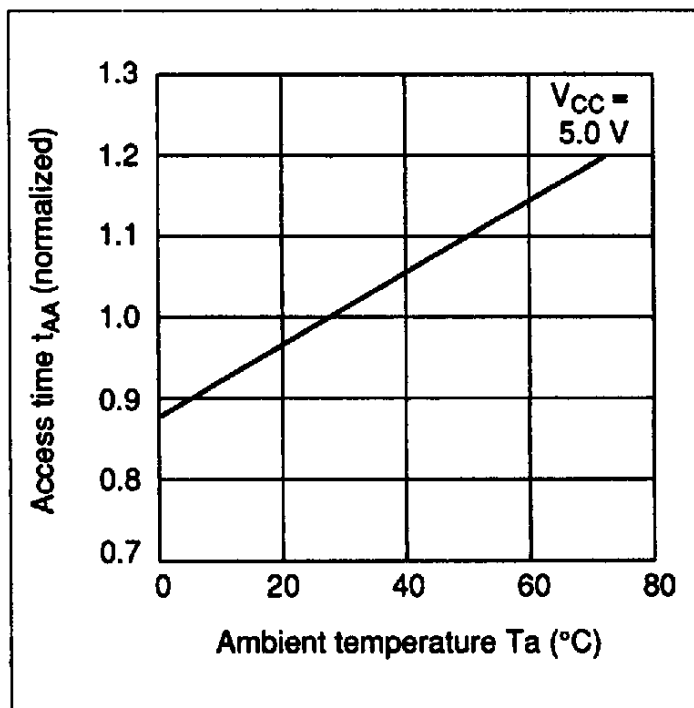

Access Time vs. Ambient Temperature

# HM62256 Series

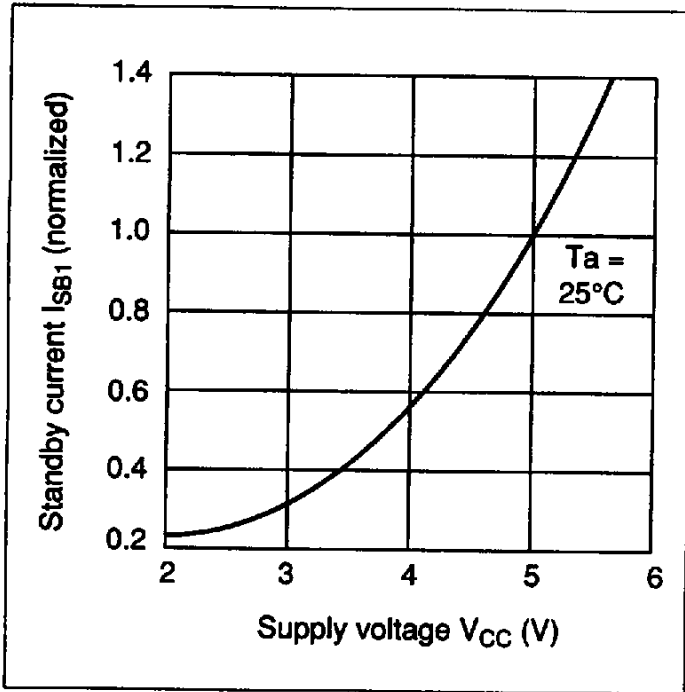

Standby Current vs. Supply Voltage

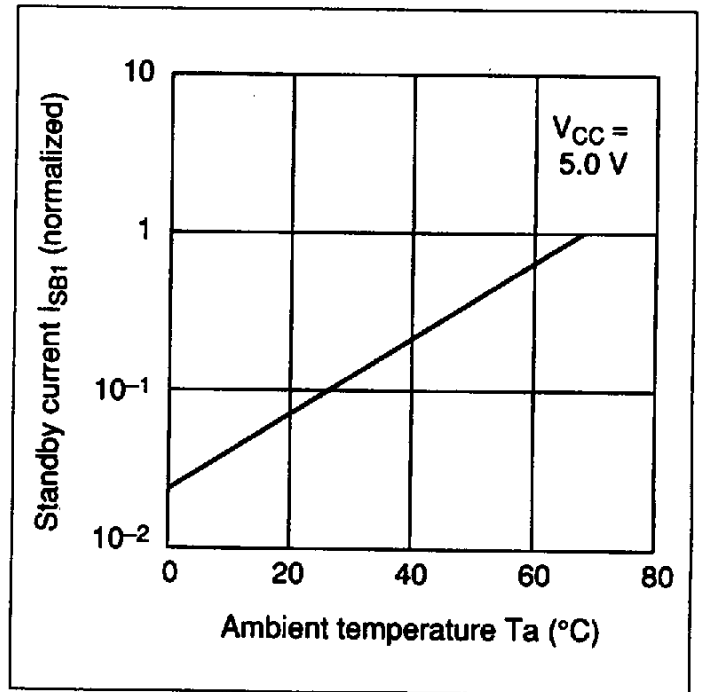

Standby Current vs. Ambient Temperature

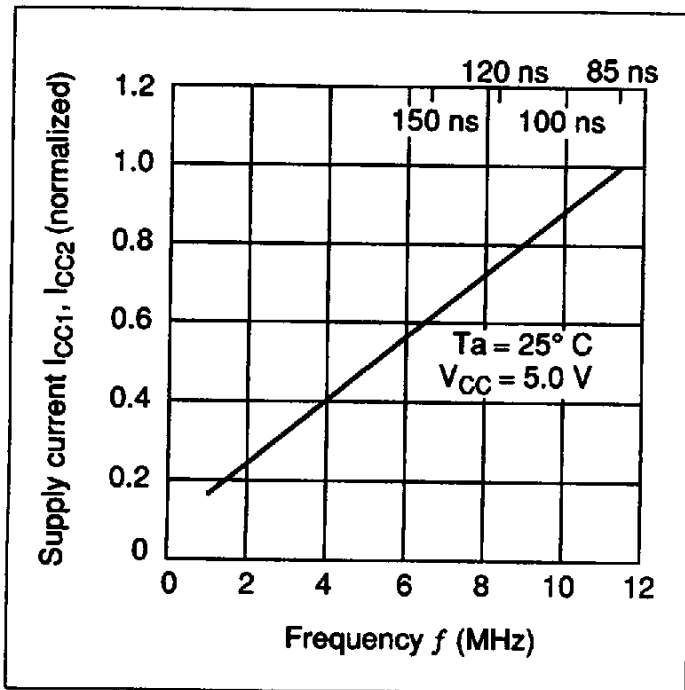

Supply Current vs. Frequency (Read)

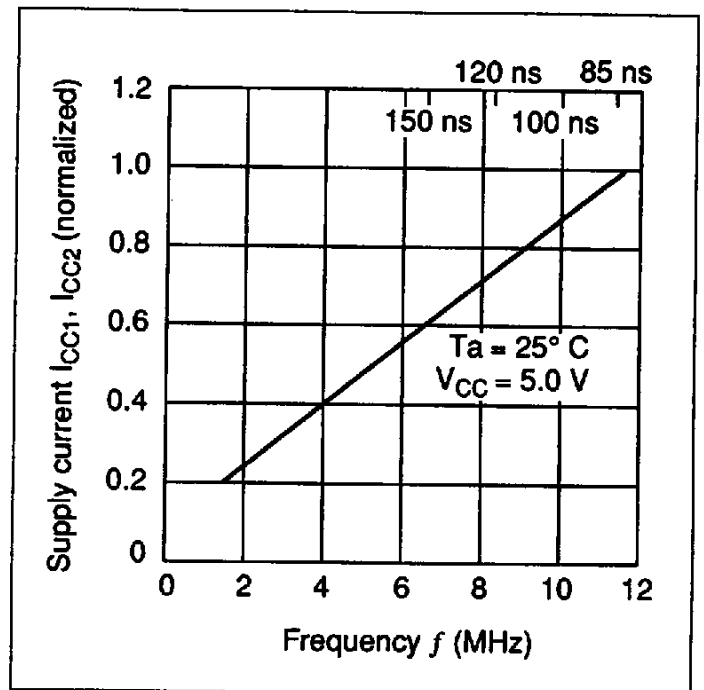

Supply Current vs. Frequency (Write)

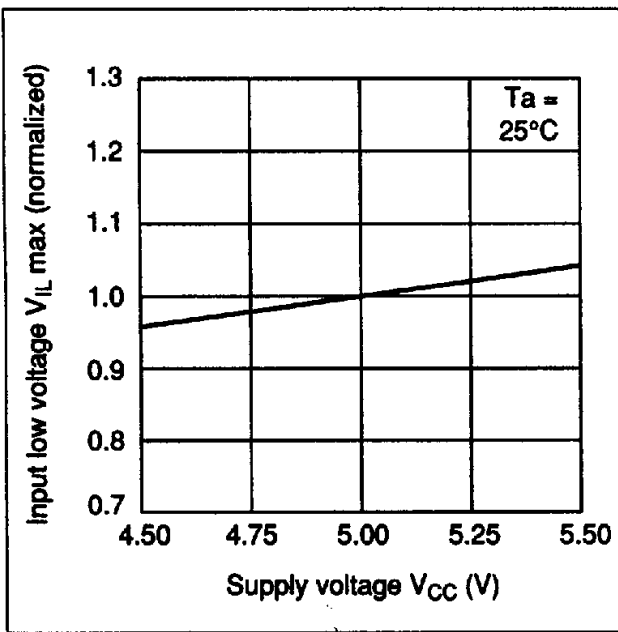

Input Low Voltage vs. Supply Voltage

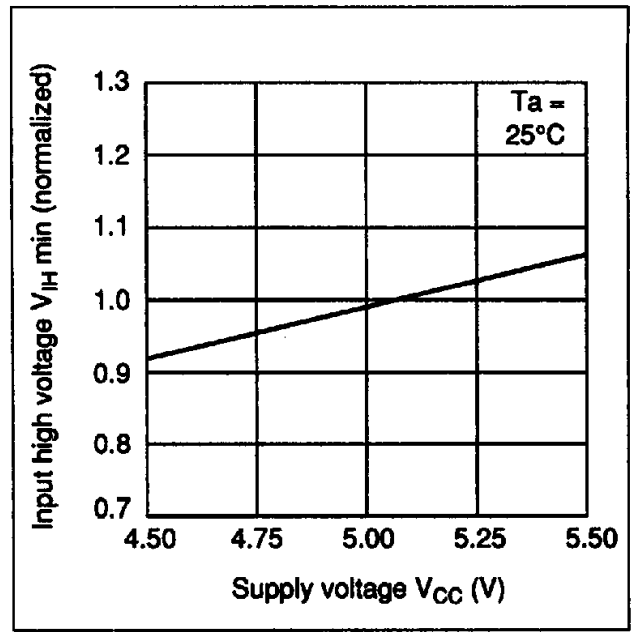

Input High Voltage vs. Supply Voltage

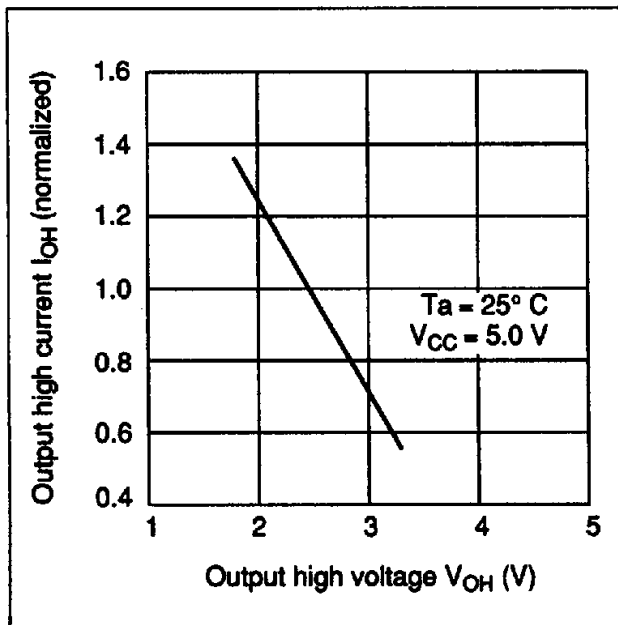

Output Current vs. Output Voltage (High)

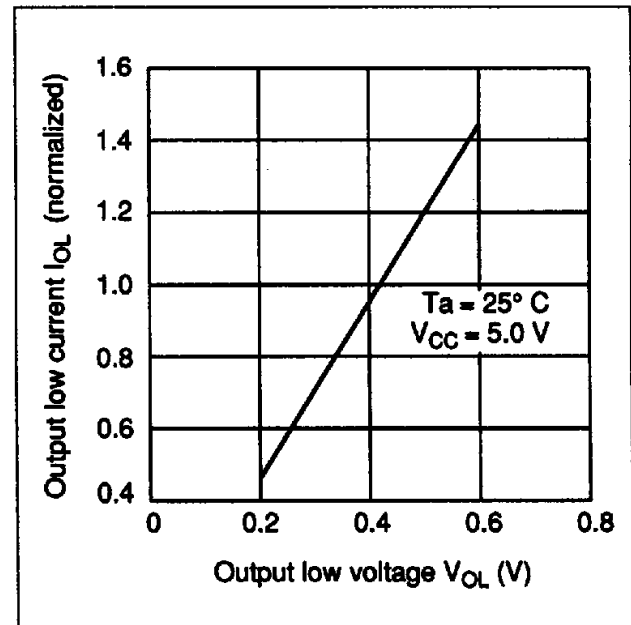

Output Current vs. Output Voltage (Low)

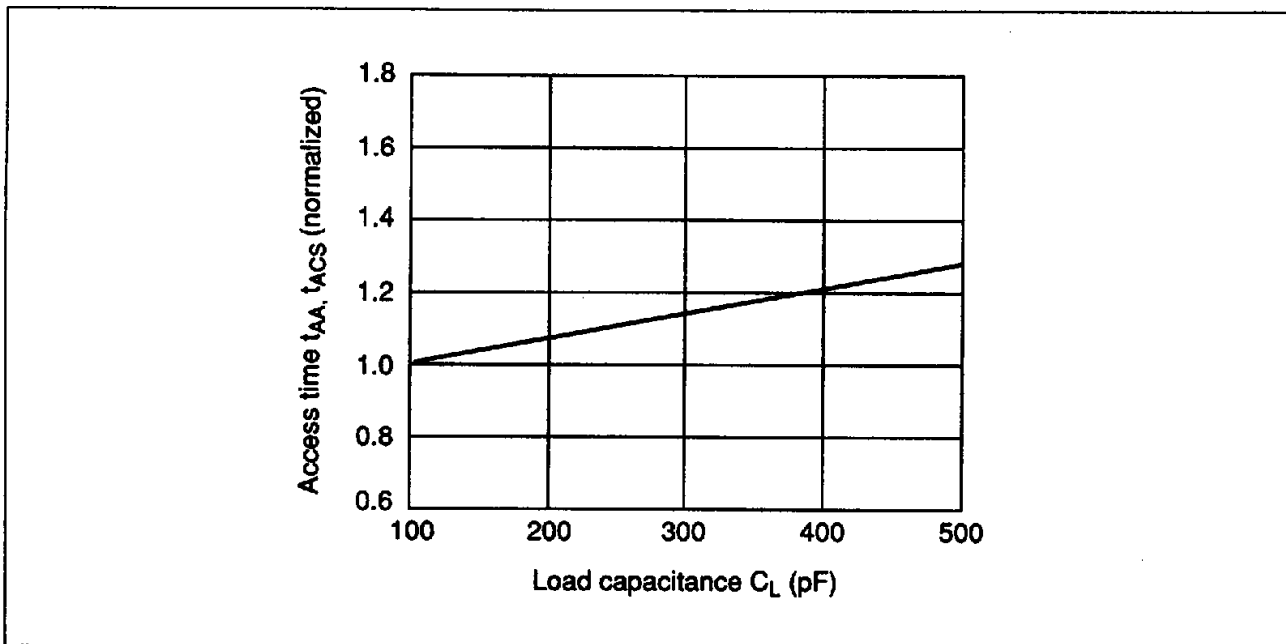

**Access Time vs. Load Capacitance**