



HM9215 SERIES (HM9215/11/10/09/05)

PROGRAMMABLE MANCHESTERCODE ENCODER/DECODER

Features

- Operating voltage range 3.0V-9.0V.
- Manchester code encoder/decoder on one chip.
- Stable operating frequency.
- On chip oscillator using inexpensive RC components. (R.C: $\pm 10\%$)
- Automatic preamble generation.
- Schmitt trigger for data input.
- Low stand-by current.

Applications

- Cordless telephone.
- Remote control.
- Car alarm control system.
- Security system.
- Digital locks.
- Paging system.

Pin Configuration and Code Patterns

HM9215

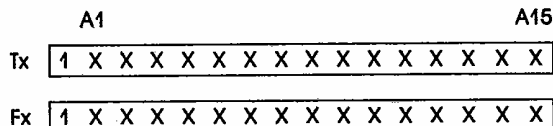
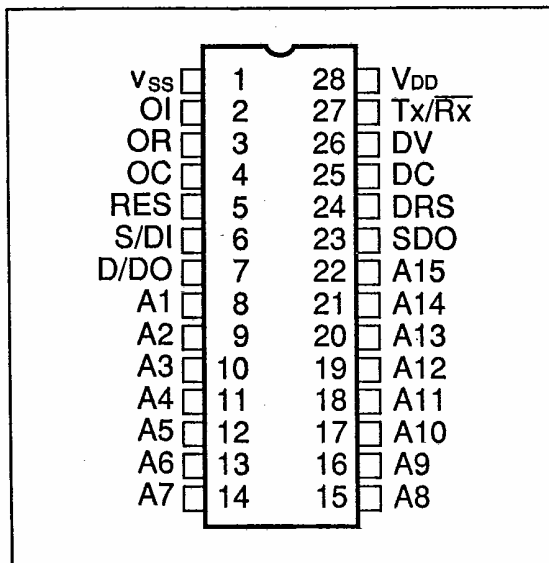

HM9211

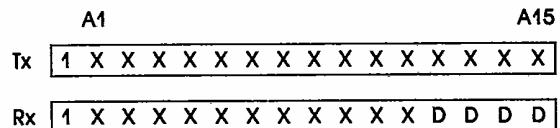
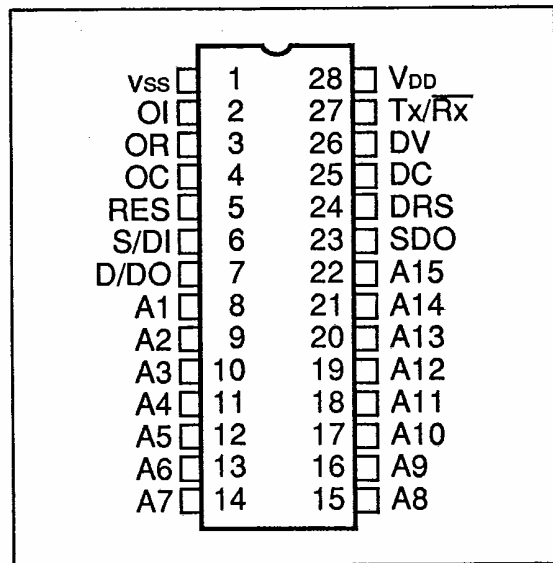



HM9215 SERIES (HM9215/11/10/09/05)

PROGRAMMABLE MANCHESTERCODE ENCODER/DECODER

HM9209

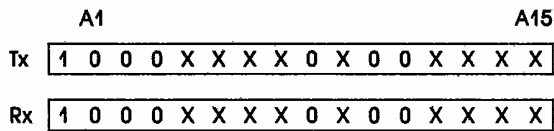
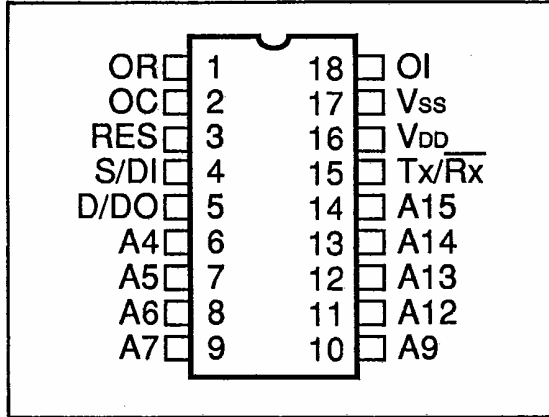

HM9210

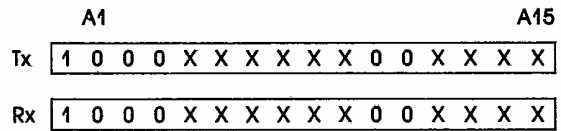
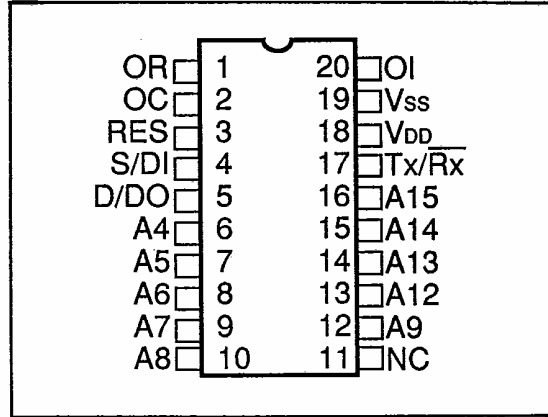

HM9205

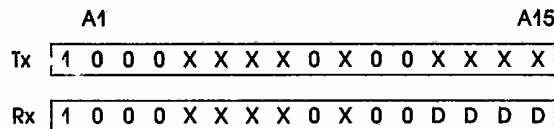
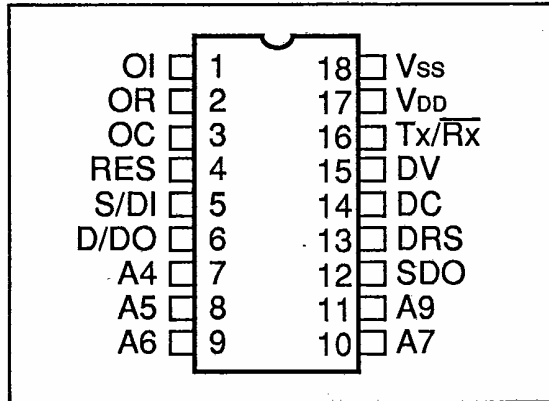

Note: X = Programmable
 0 = Hardwired Internally Zero
 1 = Hardwired Internally One
 D = Don't Care in Receive Mode