

Typical Applications

This HMC-AUH256 is ideal for:

- Point-to-Point Radios
- Point-to-Multi-Point Radios
- VSAT
- SATCOM

Features

- Gain: 21 dB
- P1dB Output Power: +20 dBm
- Wideband Performance: 17.5 to 40 GHz
- Supply Voltage: +5V @ 295 mA
- Small Chip Size: 2.1 x 0.92 x 0.1 mm

Functional Diagram

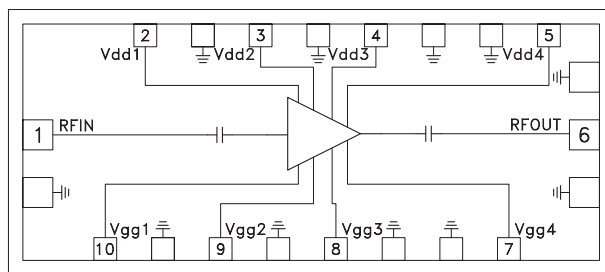

General Description

The HMC-AUH256 is a GaAs MMIC HEMT four stage Driver Amplifier which covers the frequency range of 17.5 to 40 GHz. The chip can easily be integrated into Multi-Chip-Modules (MCMs) due to its small (1.93 mm²) size. The HMC-AUH256 offers 21 dB of gain and +20 dBm output power at 1 dB compression from a bias supply of +5V @ 295 mA. The HMC-AUH256 may also be used as a frequency doubler. Detail bias condition to achieve doubler operation.

Electrical Specifications ^[1], $T_A = +25^\circ\text{C}$

$V_{dd1} = V_{dd2} = V_{dd3} = V_{dd4} = 5V$, $I_{dd1} + I_{dd2} + I_{dd3} + I_{dd4} = 295mA$ ^[2]

Parameter	Min.	Typ.	Max.	Units
Frequency Range	17.5 - 41			GHz
Gain		21		dB
Input Return Loss		8		dB
Output Return Loss		15 8		dB dB
	20 - 30 GHz			
	30 - 45 GHz			
Output Power for 1 dB Compression		20		dBm
Saturated Output Power		23		dBm
Output IP3		27		dBm
Supply Current ($I_{dd1} + I_{dd2} + I_{dd3} + I_{dd4}$)		295		mA

[1] Unless otherwise indicated, all measurements are from probed die

[2] Adjust Vgg1 = Vgg2 = Vgg3 = Vgg4 between -1V to +0.3V (Typ. -0.3V) to achieve $I_{dd1} = 50\text{ mA}$, $I_{dd2} = 50\text{ mA}$, $I_{dd3} = 75\text{ mA}$, $I_{dd4} = 120\text{ mA}$

GaAs HEMT MMIC DRIVER AMPLIFIER, 17.5 - 41.0 GHz

Linear Gain vs. Frequency

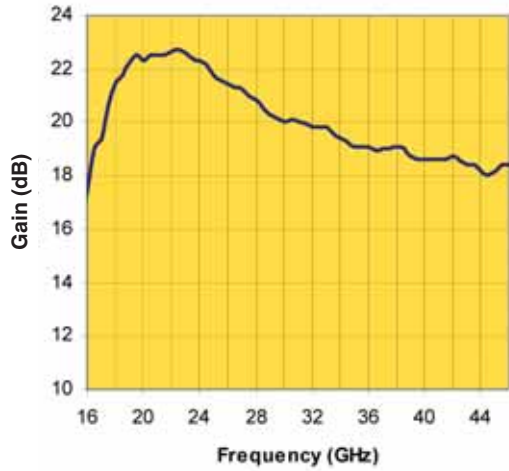

Fixtured Pout vs. Frequency

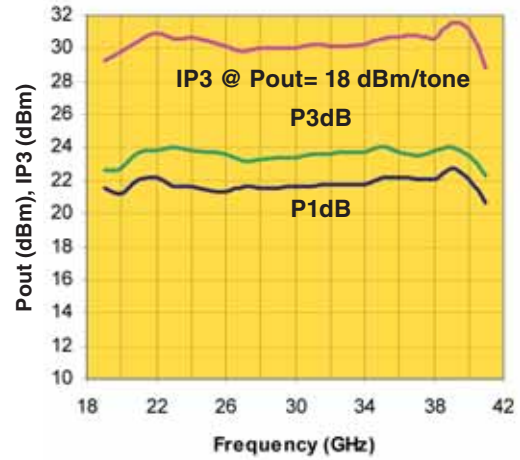

Input Return Loss vs. Frequency

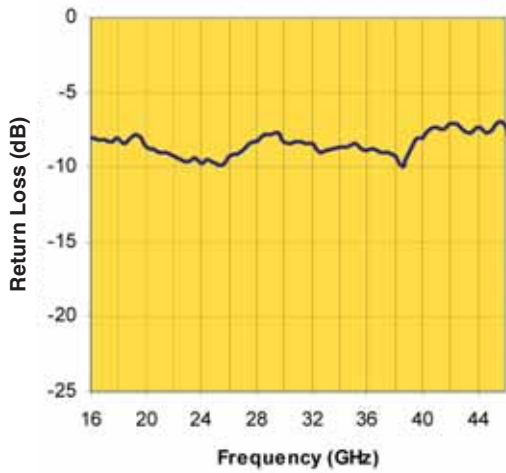

Output Return Loss vs. Frequency

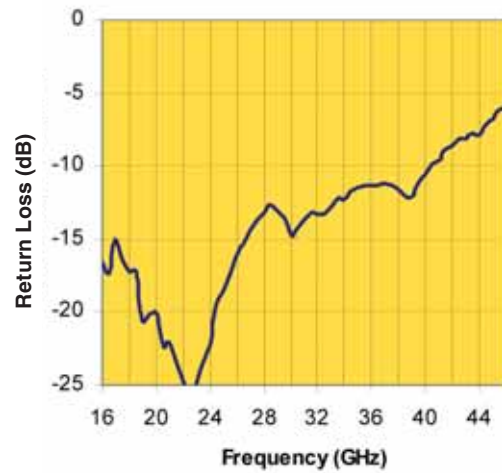

GaAs HEMT MMIC DRIVER AMPLIFIER, 17.5 - 41.0 GHz

2

DRIVER & GAIN BLOCK AMPLIFIERS - CHIP

x2 Pout vs. Frequency (vs Pad)

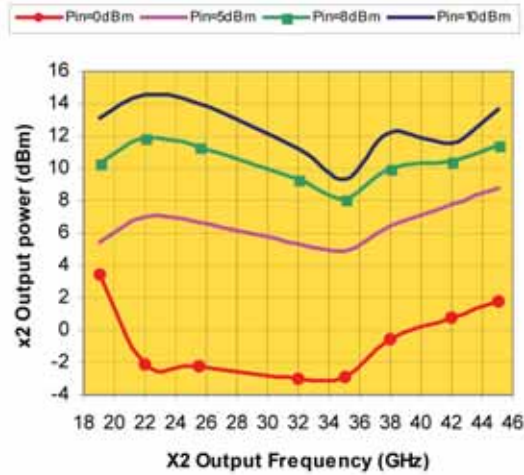

Fixtured Pout vs. Frequency @ Pin= 8 dBm

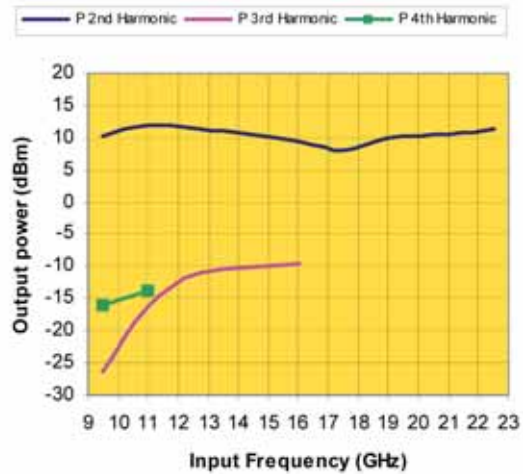

Fixtured Pout vs. Frequency @ Pin= 10 dBm

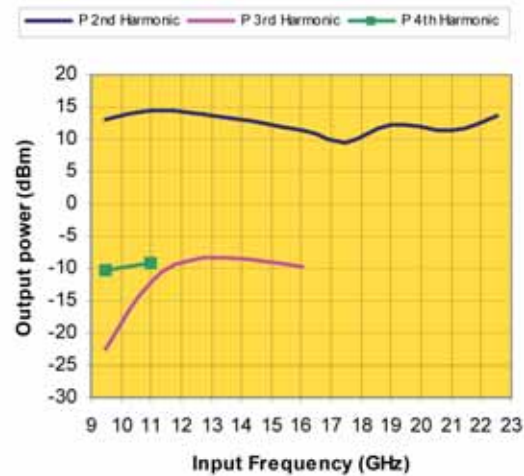

Absolute Maximum Ratings

Drain Bias Voltage	+5.5 Vdc
RF Input Power	15 dBm
Drain Bias Current (Idd1, Idd2)	62 mA
Drain Bias Current (Idd3)	93 mA
Drain Bias Current (Idd4)	150 mA
Gate Bias Voltage	-1 to +0.3 Vdc
Channel Temperature	180 °C
Thermal Resistance (channel to die bottom)	77.5 °C/W
Storage Temperature	-65 to +150 °C



ELECTROSTATIC SENSITIVE DEVICE
OBSERVE HANDLING PRECAUTIONS

Note: Multiplier Performance Characteristics (Typical Performance at 25°C)
Vd1= 2V, Vd2= Vd3= Vd4= 5V, Id1= 5mA, Id2+Id3+Id4= 245mA

**GaAs HEMT MMIC DRIVER
AMPLIFIER, 17.5 - 41.0 GHz**

Outline Drawing

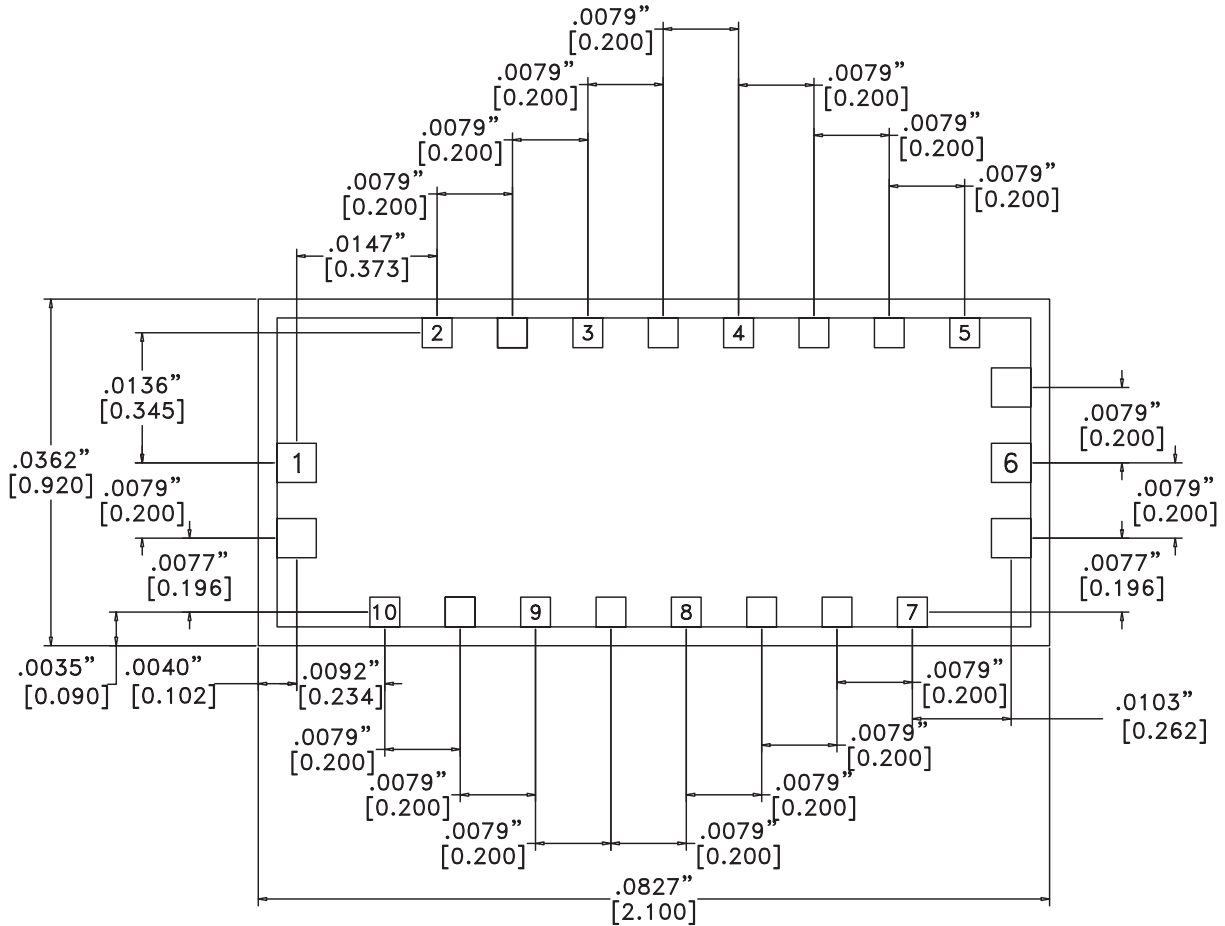

NOTES:

1. ALL DIMENSIONS ARE IN INCHES [MM].
2. TYPICAL BOND PAD IS .004" SQUARE.
3. BACKSIDE METALLIZATION: GOLD.
4. BACKSIDE METAL IS GROUND.
5. BOND PAD METALLIZATION: GOLD.
6. CONNECTION NOT REQUIRED FOR UNLABELED BOND PADS.
7. OVERALL DIE SIZE $\pm .002$ "

Die Packaging Information ^[1]



Standard	Alternate
GP - 2	[2]

[1] Refer to the "Packaging Information" section for die packaging dimensions.

[2] For alternate packaging information contact Hittite Microwave Corporation.

GaAs HEMT MMIC DRIVER AMPLIFIER, 17.5 - 41.0 GHz

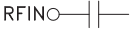
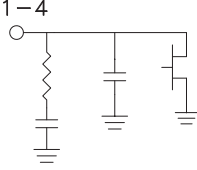
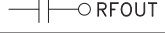
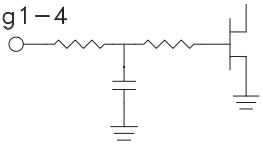
Pad Descriptions

Pad Number	Function	Pad Description	Interface Schematic
1	RFIN	This pad is AC coupled and matched to 50 Ohms.	RFIN 
2 - 5	Vdd1-4	Power supply voltage for amplifier. See Assembly Diagram for required external components.	Vdd1-4 
6	RFOUT	This pad is AC coupled and matched to 50 Ohms.	 RFOUT
7 - 10	Vgg1-4	Gate control for amplifier. Please follow "MMIC Amplifier Biasing Procedure" application note. See assembly for required external components.	Vgg1-4 
Die Bottom	GND	Die Bottom must be connected to RF/DC ground.	 GND

**GaAs HEMT MMIC DRIVER
 AMPLIFIER, 17.5 - 41.0 GHz**

Assembly Diagram

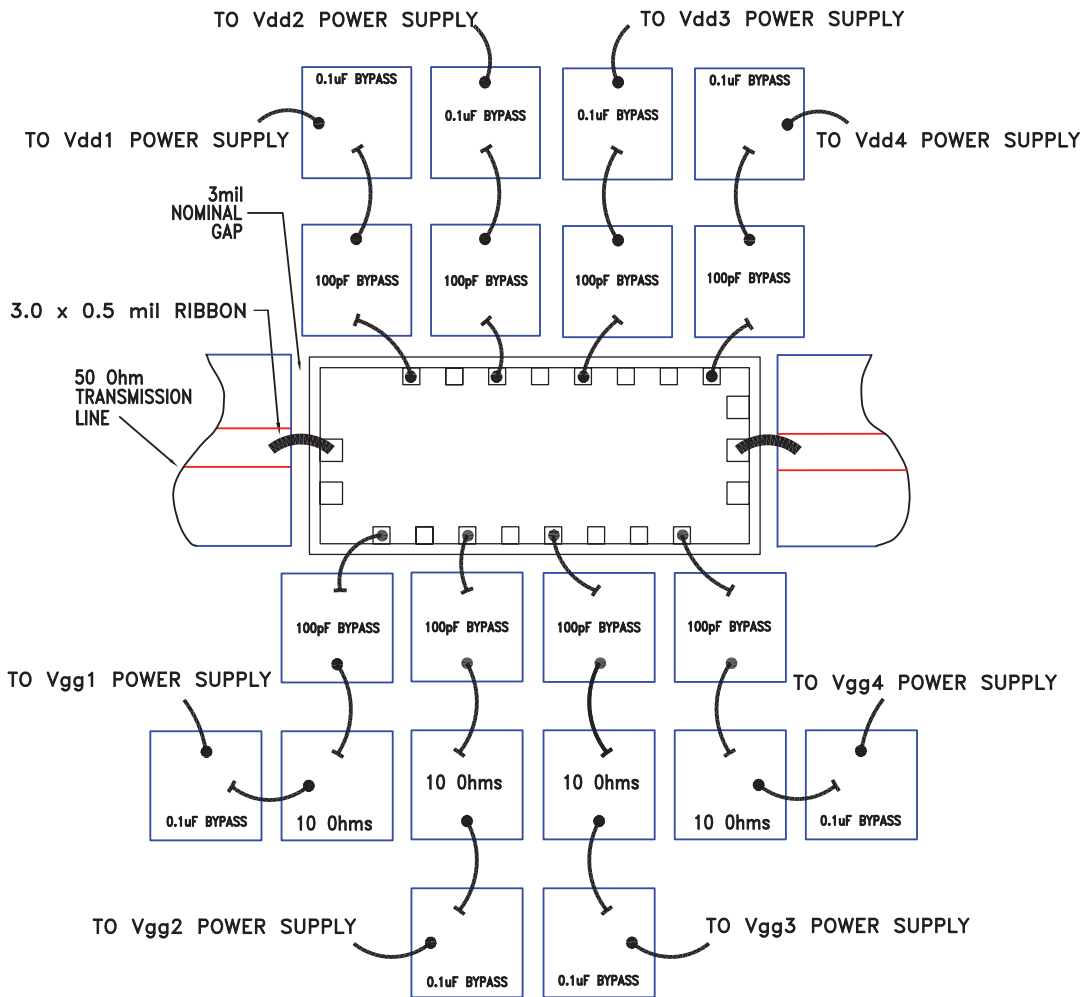

- Note 1: Bypass caps should be 100 pF (approximately) ceramic (single-layer) placed no farther than 30 mils from the amplifier.
 Note 2: Best performance obtained from use of <10 mil (long) by 3 by 0.5mil ribbons on input and output.
 Note 3: Vdd3 can be biased using on-chip pads Vdd3 or Vdd4