

WIDEBAND DRIVER AMPLIFIER MODULE, 10 MHz - 20 GHz



Typical Applications

The HMC-C004 Wideband Driver is ideal for:

- OC192 LN/MZ Modulator Driver
- Telecom Infrastructure
- Microwave Radio & VSAT
- Military & Space
- Test Instrumentation

Functional Diagram

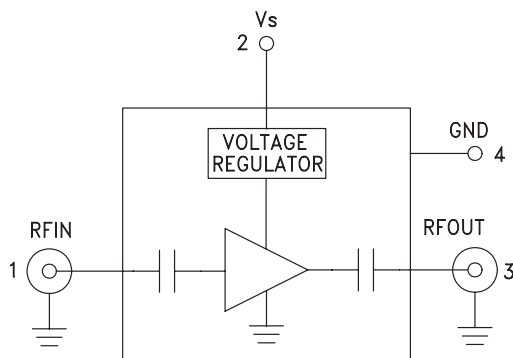

Features

- Gain: 15 dB
- +24 dBm Saturated Output Power
- 50 Ohm Matched Input/Output
- Regulated Supply and Bias Sequencing
- Hermetically Sealed Module
- Field Replaceable SMA connectors
- 55 to +85°C Operating Temperature

General Description

The HMC-C004 is a GaAs MMIC PHEMT Distributed Driver Amplifier in a miniature, hermetic module with replaceable SMA connectors which operates between 10 MHz and 20 GHz. The self-biased amplifier provides 15 dB of gain, 3 to 4 dB noise figure and +24 dBm of saturated output power while requiring a single +12V supply. Gain flatness is excellent at ± 0.5 dB as well as ± 2 deg deviation from linear phase from 0.01 to 10 GHz making the HMC-C004 ideal for OC192 fiber optic LN/MZ modulator driver applications. The wideband amplifier I/Os are internally matched to 50 Ohms and are internally DC blocked.

Electrical Specifications, $T_A = +25^\circ\text{C}$, $V_s = +11.6\text{V}$ to $+12.4\text{V}$

Parameter	Min.	Typ.	Max.	Min.	Typ.	Max.	Min.	Typ.	Max.	Units
Frequency Range	0.010 - 6.0			6.0 - 12.0			12.0 - 20.0			GHz
Gain	14	16		13	15		10	13		dB
Gain Flatness		± 0.5			± 0.5			± 1.0		dB
Gain Variation Over Temperature		0.012	0.02		0.012	0.02		0.012	0.02	dB/°C
Noise Figure		3			3			4		dB
Input Return Loss		19			17			10		dB
Output Return Loss		14			14			10		dB
Output Power for 1 dB Compression (P1dB)	20	23		19	22		17	20		dBm
Saturated Output Power (Psat)		25			24			22		dBm
Output Third Order Intercept (IP3)		33			30			26		dBm
Saturated Output Voltage		10			10			8		Vpk-pk
Group Delay		± 3			± 3			± 3		ps
Spurious Response		-50			-60			-60		dBc
Supply Current		195			195			195		mA

For price, delivery, and to place orders, please contact Hittite Microwave Corporation:
 20 Alpha Road, Chelmsford, MA 01824 Phone: 978-250-3343 Fax: 978-250-3373
 Order On-line at www.hittite.com

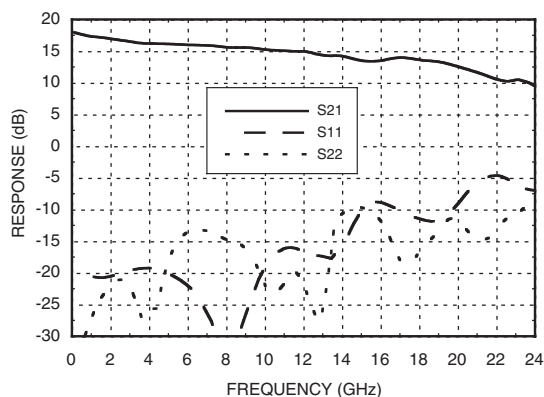
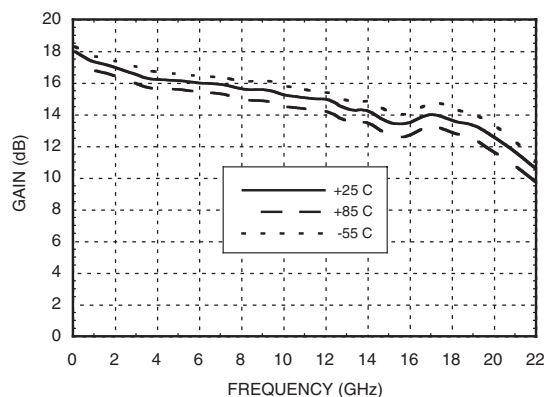
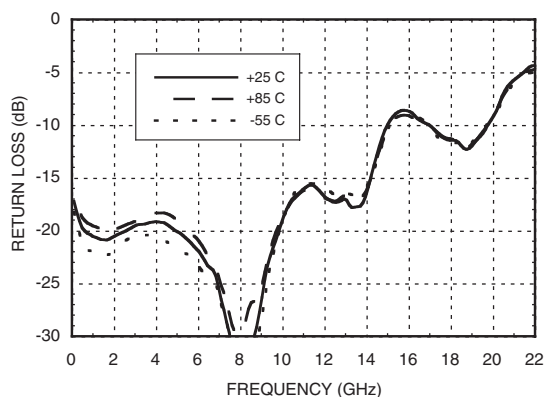
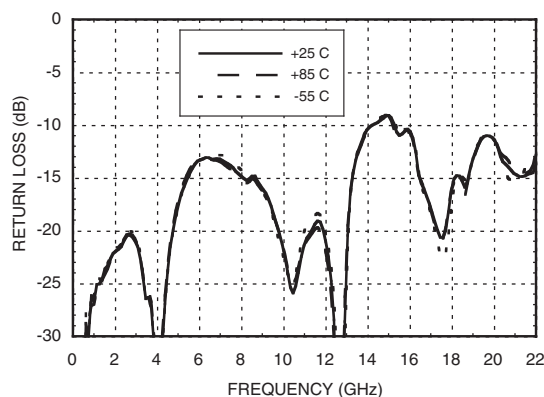
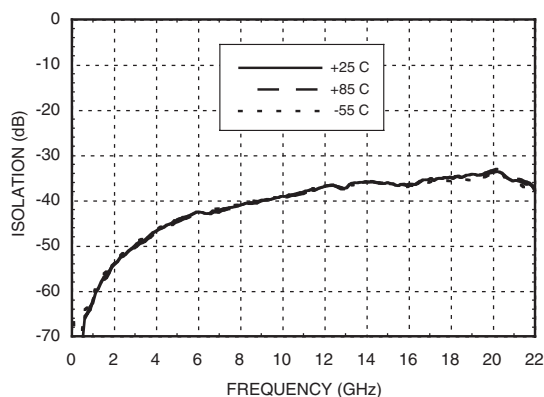
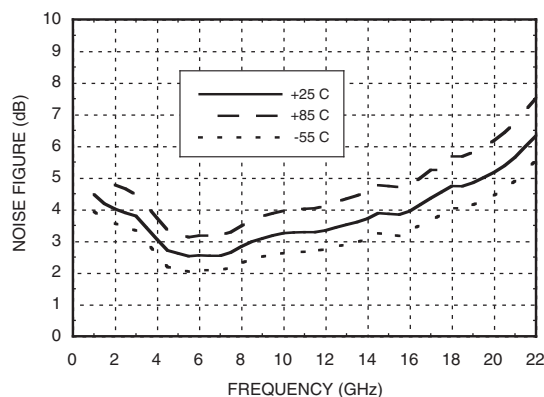
**WIDEBAND DRIVER AMPLIFIER
 MODULE, 10 MHz - 20 GHz**
Gain & Return Loss**Gain vs. Temperature****Input Return Loss vs. Temperature****Output Return Loss vs. Temperature****Reverse Isolation vs. Temperature****Noise Figure vs. Temperature**

**WIDEBAND DRIVER AMPLIFIER
 MODULE, 10 MHz - 20 GHz**

9

AMPLIFIERS - CONNECTORIZED MODULES

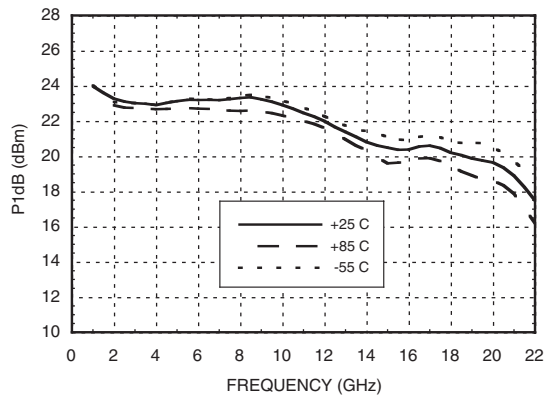
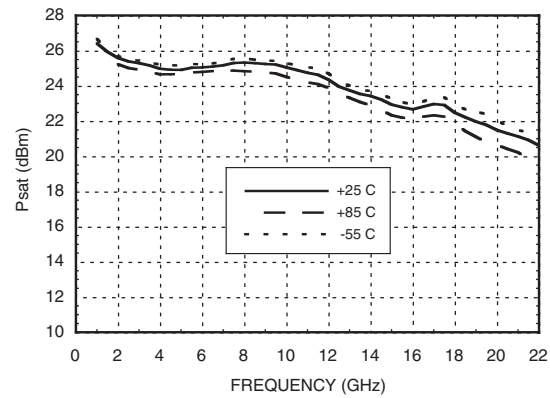
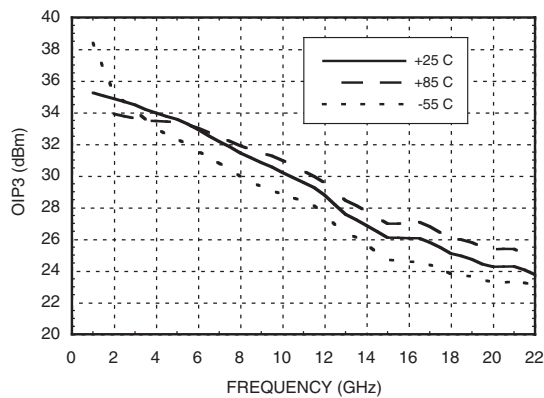
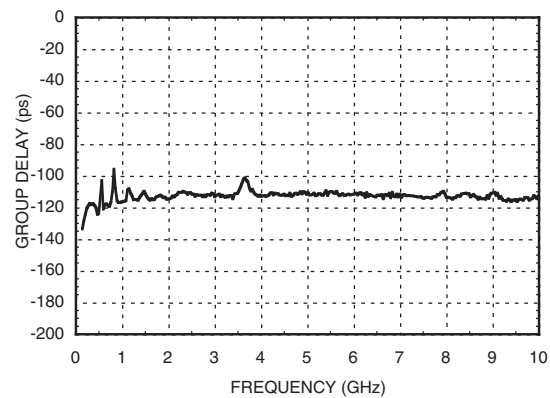
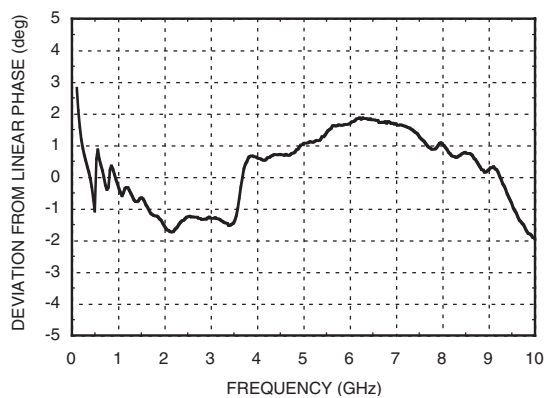
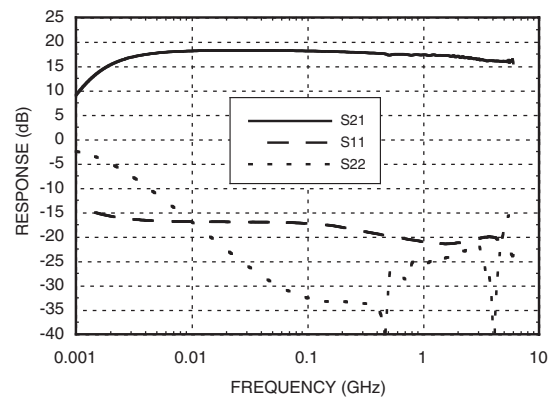
P1dB vs. Temperature**Psat vs. Temperature****Output IP3 vs. Temperature****Group Delay****Deviation from Linear Phase****Low Frequency Gain and Return Loss**

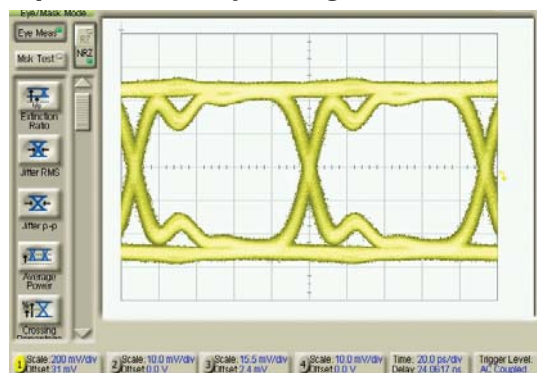
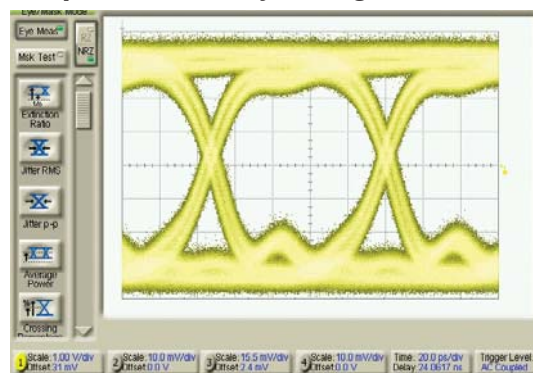
**WIDEBAND DRIVER AMPLIFIER
 MODULE, 10 MHz - 20 GHz**
Input OC-192 Eye Diagram ^{[1][2]}**Output OC-192 Eye Diagram ^{[1][3]}**

[1] Test Conditions:

Pattern generated with an Agilent N4901B Serial BERT
 Eye diagram data presented on an infiniium DCA 86100A.
 Rate = 10.709 GB/s
 Pseudo Random Code = 2²³-1



[2] Vertical Scale = 200 mV/Div.

[3] Vertical Scale = 1 V/Div.

Absolute Maximum Ratings

Bias Supply Voltage (Vs)	+11 Vdc to +13 Vdc
RF Input Power (RFIn)	+23 dBm
Storage Temperature	-65 to +150 °C
Operating Temperature	-55 to +85 °C

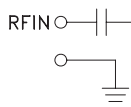
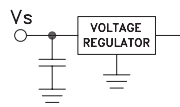
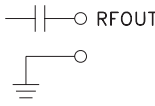

**ELECTROSTATIC SENSITIVE DEVICE
 OBSERVE HANDLING PRECAUTIONS**
Pin Descriptions

Pin Number	Function	Description	Interface Schematic
1	RFIN & RF Ground	RF input connector, SMA female, field replaceable. This pin is AC coupled and matched to 50 Ohms from 0.01 - 20.0 GHz.	
2	Vs	Power supply voltage for the amplifier.	
3	RFOUT & RF Ground	RF output connector, SMA female. This pin is AC coupled and matched to 50 Ohms from 0.01 - 20.0 GHz.	
4	GND	Power supply ground.	

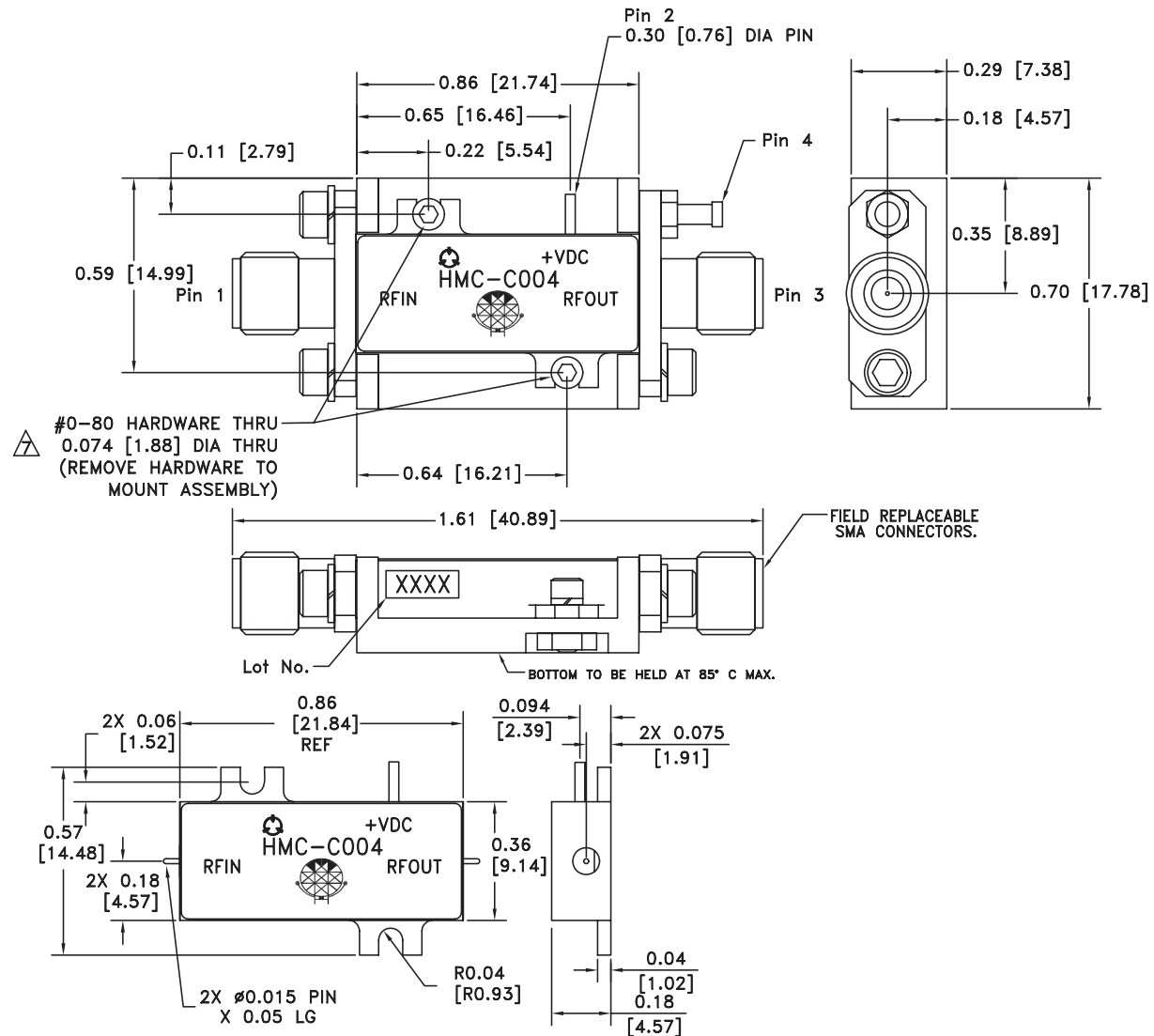
For price, delivery, and to place orders, please contact Hittite Microwave Corporation:
 20 Alpha Road, Chelmsford, MA 01824 Phone: 978-250-3343 Fax: 978-250-3373
 Order On-line at www.hittite.com

**WIDEBAND DRIVER AMPLIFIER
 MODULE, 10 MHz - 20 GHz**
Outline Drawing**NOTES:**

1. PACKAGE, LEADS, COVER MATERIAL: KOVAR™
2. SPACER MATERIAL: ALUMINUM
3. PLATING: ELECTROLYTIC GOLD 50 MICROINCHES MIN., OVER ELECTROLYTIC NICKEL 75 MICROINCHES MIN.
4. ALL DIMENSIONS ARE IN INCHES [MILLIMETERS].
5. TOLERANCES \pm 0.005 [0.13] UNLESS OTHERWISE SPECIFIED.
6. FIELD REPLACEABLE SMA CONNECTORS.
 TENSOLITE 5602 - 5CCSF OR EQUIVALENT.

 TO MOUNT MODULE TO SYSTEM PLATFORM REPLACE 0-80 HARDWARE WITH DESIRED MOUNTING SCREWS.



HMC-C004

WIDEBAND DRIVER AMPLIFIER MODULE, 10 MHz - 20 GHz

Notes: