

### Typical Applications

The HMC-C016 Wideband LNA is ideal for:

- Telecom Infrastructure
- Microwave Radio & VSAT
- Military & Space
- Test Instrumentation
- Fiber Optics

### Functional Diagram

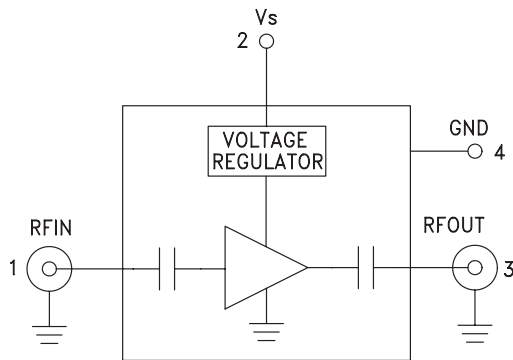

### Features

Noise Figure: 2 dB @ 16 GHz

Gain: 22 dB

P1dB Output Power: +14 dBm @ 16 GHz

50 Ohm Matched Input/Output

Regulated Supply

Hermetically Sealed Module

Field Replaceable SMA Connectors

-55 to +85°C Operating Temperature

### General Description

The HMC-C016 is a GaAs MMIC PHEMT Low Noise Amplifier in a miniature, hermetic module which operates between 7 and 17 GHz. This high dynamic range amplifier provides 22 dB of gain, 2 dB noise figure and up to +14 dBm of output power at 1 dB gain compression while operating from a single positive supply between +8 and +16 volts. The I/Os are internally matched to 50 Ohms and internally DC blocked for robust performance. The module features removable SMA connectors which can be detached to allow direct connection of the I/O pins to a microstrip or coplanar circuit.

### Electrical Specifications, $T_A = +25^\circ\text{C}$ , $V_s = +8\text{V}$ to $+16\text{V}$

Parameter	Min.	Typ.	Max.	Min.	Typ.	Max.	Min.	Typ.	Max.	Units
Frequency Range	7 - 9			9 - 13			13 - 17			GHz
Gain	17.5	20.5		19	22		18	21		dB
Gain Variation Over Temperature		0.02	0.025		0.02	0.025		0.02	0.025	dB/°C
Noise Figure		3	4.5		2.5	3		2	3.0	dB
Input Return Loss		8			10			10		dB
Output Return Loss		20			25			15		dB
Output Power for 1 dB Compression (P1dB)	8	12		11	14		11	14		dBm
Saturated Output Power (Psat)		17			18			18		dBm
Output Third Order Intercept (IP3)		24			25			25		dBm
Supply Current		93			93			93		mA

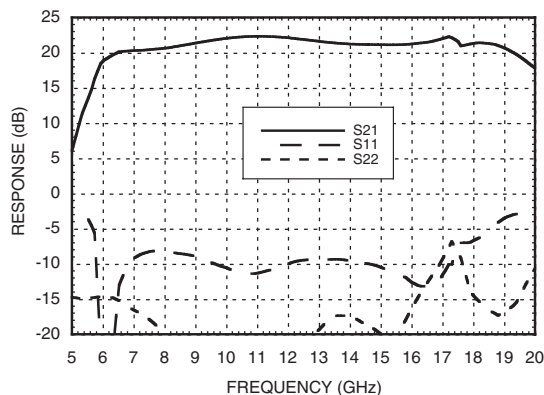
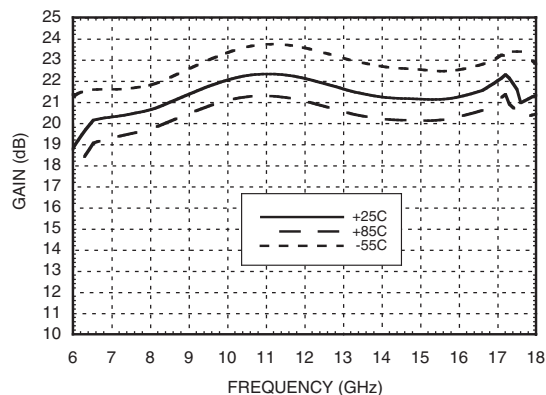
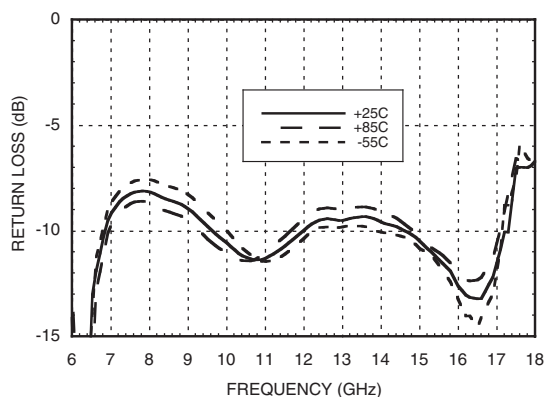
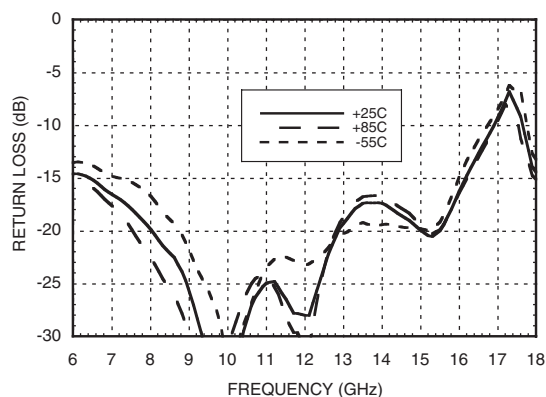
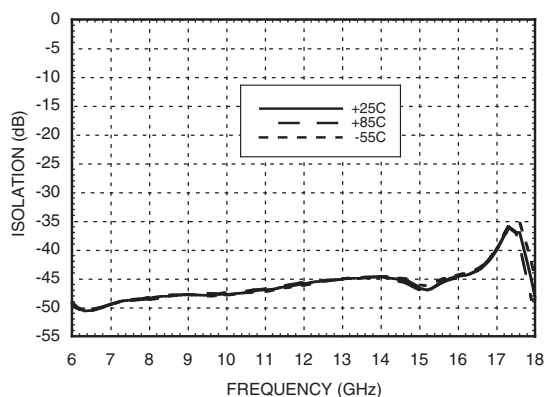
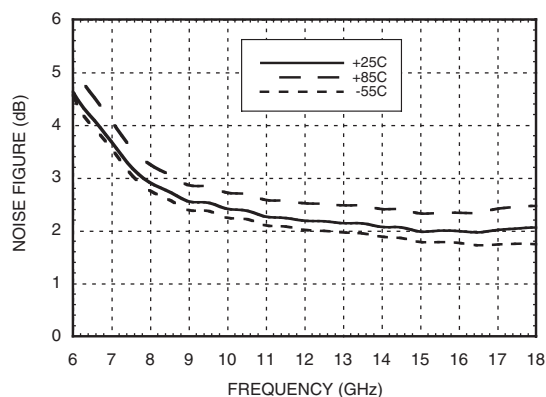
**Gain & Return Loss****Gain vs. Temperature****Input Return Loss vs. Temperature****Output Return Loss vs. Temperature****Reverse Isolation vs. Temperature****Noise Figure vs. Temperature**

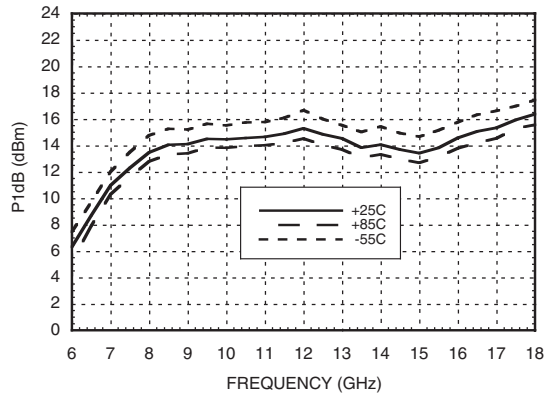
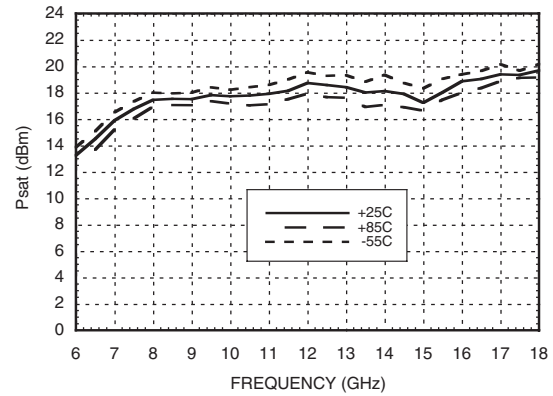
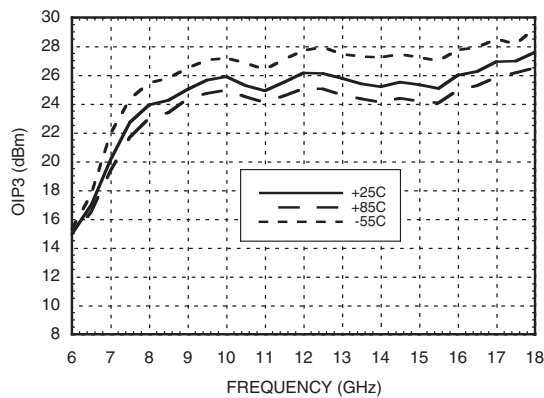
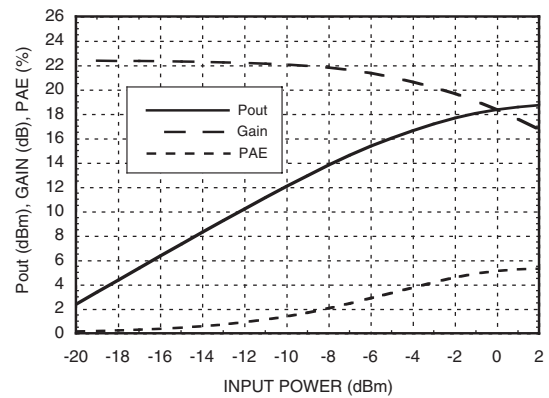

**P1dB vs. Temperature****Psat vs. Temperature****Output IP3 vs. Temperature****Power Compression @ 12 GHz****Absolute Maximum Ratings**

Bias Supply Voltage (Vs)	-0.3 Vdc to +25 Vdc
RF Input Power (RFin)	+10 dBm
Storage Temperature	-65 to +150 °C
Operating Temperature	-55 to +85 °C

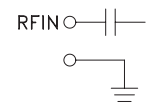
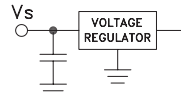
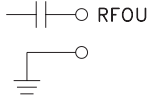

**ELECTROSTATIC SENSITIVE DEVICE**  
**OBSERVE HANDLING PRECAUTIONS**

**Pin Descriptions**

Pin Number	Function	Description	Interface Schematic
1	RFIN & RF Ground	RF input connector, SMA female, field replaceable. This pin is AC coupled and matched to 50 Ohms from 7 - 17 GHz.	
2	Vs	Power supply voltage for the amplifier.	
3	RFOUT & RF Ground	RF output connector, SMA female, field replaceable. This pin is AC coupled and matched to 50 Ohms from 7 - 17 GHz.	
4	GND	Power supply ground.	

## Outline Drawing

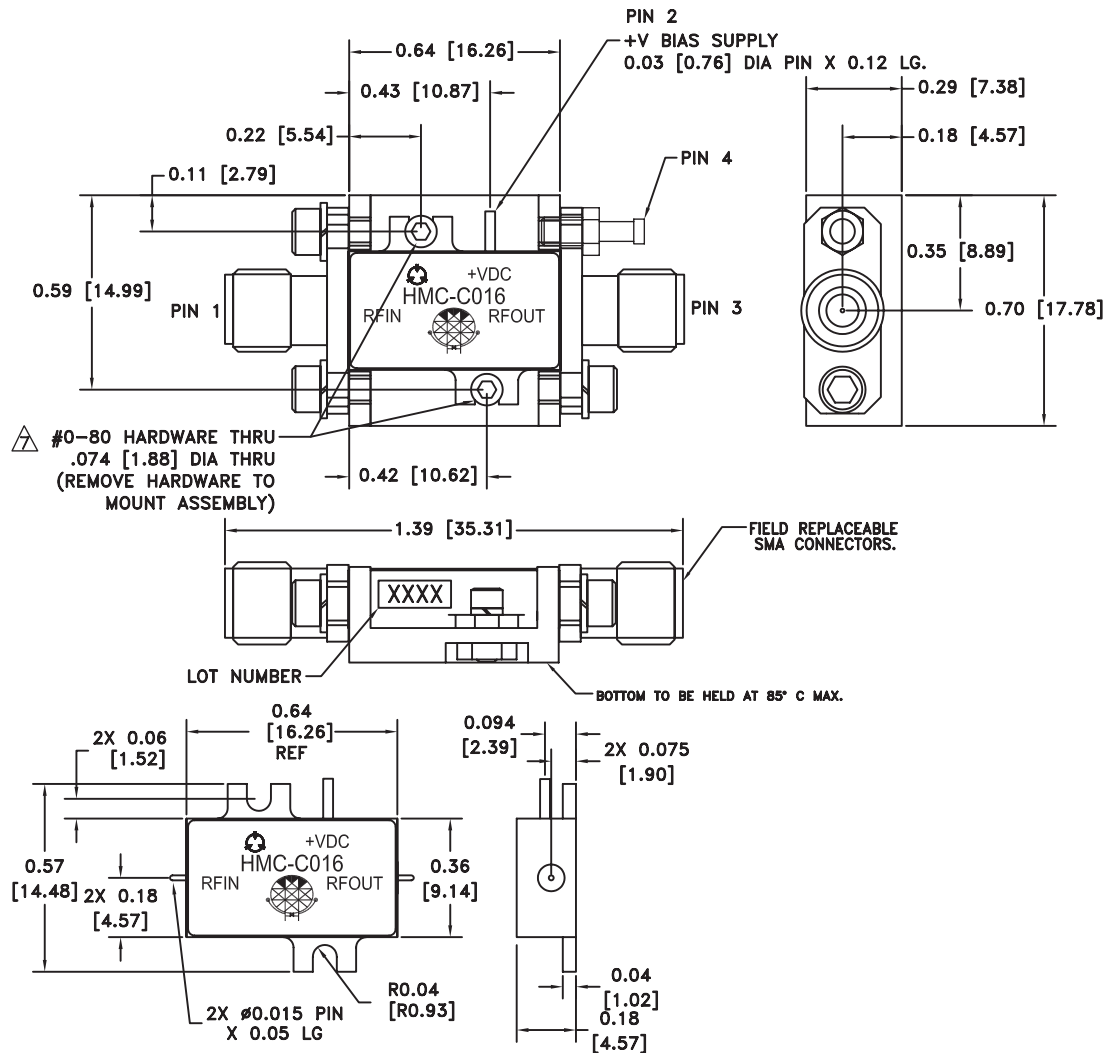

## NOTES:

1. PACKAGE, LEADS, COVER MATERIAL: KOVAR™
2. SPACER MATERIAL: ALUMINUM
3. PLATING: ELECTROLYTIC GOLD 50 MICROINCHES MIN., OVER ELECTROLYTIC NICKEL 75 MICROINCHES MIN.
4. ALL DIMENSIONS ARE IN INCHES [MILLIMETERS].
5. TOLERANCES ±.005 [0.13] UNLESS OTHERWISE SPECIFIED.
6. FIELD REPLACEABLE SMA CONNECTORS.  
TENSOLITE 5602 - 5CCSF OR EQUIVALENT.

 TO MOUNT MODULE TO SYSTEM PLATFORM REPLACE 0-80 HARDWARE WITH DESIRED MOUNTING SCREWS.



**HMC-C016**

**WIDEBAND LNA MODULE, 7 - 17 GHz**

**Notes:**

---

For price, delivery, and to place orders, please contact Hittite Microwave Corporation:  
20 Alpha Road, Chelmsford, MA 01824 Phone: 978-250-3343 Fax: 978-250-3373  
Order On-line at [www.hittite.com](http://www.hittite.com)