



VOLTAGE VARIABLE ATTENUATOR MODULE, DC - 20 GHz



Features

- Wide Bandwidth: DC - 20 GHz
- Low Phase Shift vs. Attenuation
- 30 dB Attenuation Range Up to 12 GHz
- Hermetically Sealed Module
- Field Replaceable SMA Connectors
- 55 to +85 C Operating Temperature

Typical Applications

The HMC-C053 is ideal for:

- Telecom Infrastructure
- Military Radio, Radar & ECM
- Space Systems
- Test Instrumentation

Functional Diagram

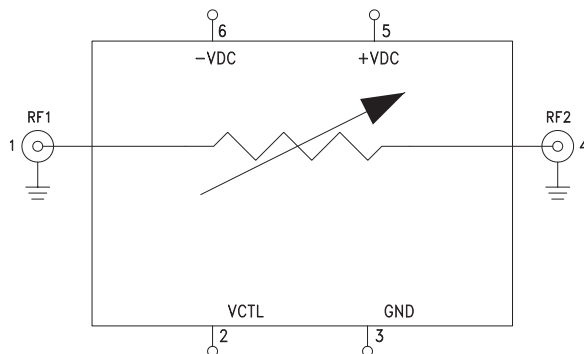

General Description

The HMC-C053 is an absorptive Voltage Variable Attenuator (VVA) operating from DC - 20 GHz. The HMC-C053 features a simple single voltage attenuation control, 0 to -3V. The device is ideal in designs where an analog DC control signal must control RF signal levels over a 30 dB amplitude range. Its broad frequency range makes it an attractive choice for many applications particularly those involved with AGC or temperature compensation of multiple gain stages, typically found in microwave radio or test instrumentation architecture. Removable SMA connectors can be detached to allow direct connection of the module's I/O pins to a microstrip or coplanar circuit.

Electrical Specifications, $T_A = +25^\circ\text{C}$, with +Vdc = +5V, Vdc = -5V & VCTL = 0 to -3V

Parameter	Frequency (GHz)	Min.	Typ.	Max.	Units
Insertion Loss (VCTL = 0V)	DC - 5		1.5		dB
	5 - 10		1.9		dB
	10 - 14		2.4		dB
	14 - 20		4.0		dB
Attenuation Range (VCTL = -2.9V)	DC - 5	30	32		dB
	5 - 10	31	33		dB
	10 - 14	27	30		dB
	14 - 20	23	26		dB
Return Loss at RF1	DC - 14		15		dB
	DC - 20		8		dB
Input Power for 0.25 dB Compression	0.5 - 8.0	Min Attenuation	7		dBm
		Attenuation > 5 dB	-4		dBm
Input Third Order Intercept Point (Two-Tone Input Power= 10 dBm Each Tone)	0.5 - 16	Min Attenuation	22		dBm
		Attenuation > 10 dB	25		dBm
Switching Characteristics tRISE, tFALL (10/90% RF) tON/tOFF (50% CTL to 10/90% RF)			3		ns
			9		ns



VOLTAGE VARIABLE ATTENUATOR MODULE, DC - 20 GHz

**Insertion Loss vs.
Frequency Over Temperature**

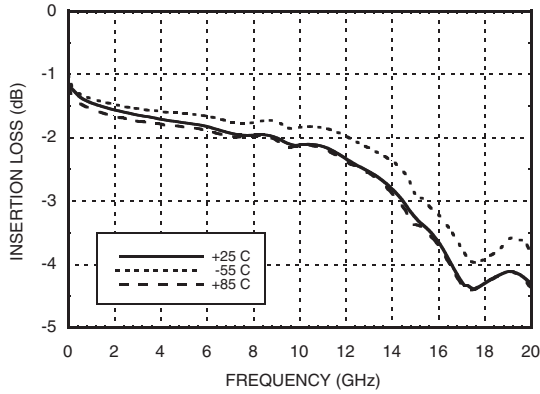

**Return Loss RF1 vs.
Frequency Over Attenuation**

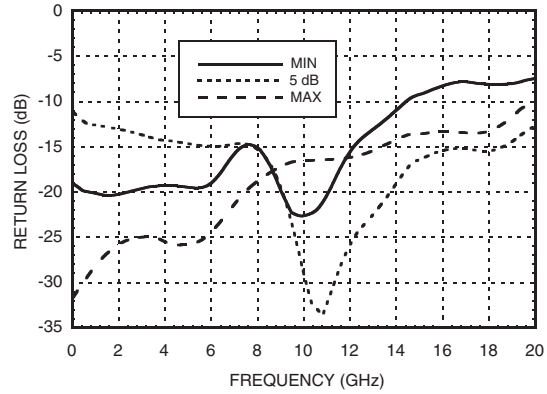

Relative Attenuation vs. Frequency

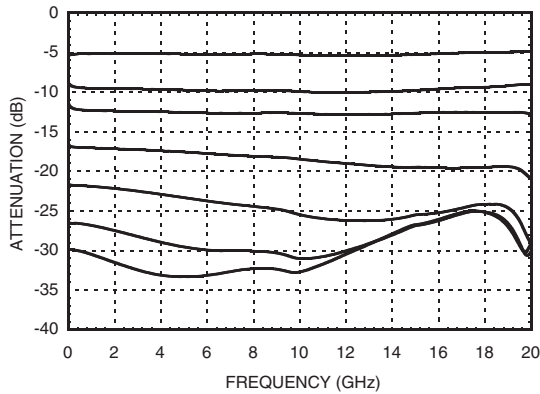

**Relative Attenuation vs.
Control Voltage @ 10 GHz**

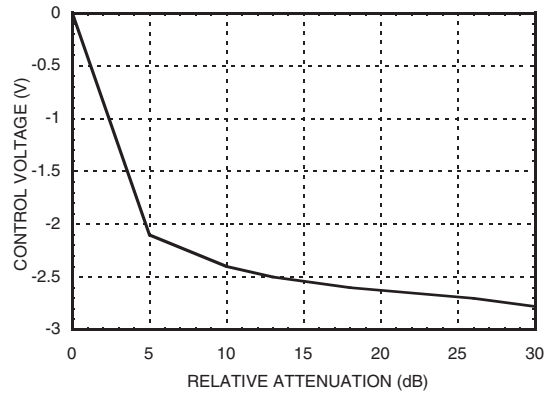

Relative Phase vs. Frequency

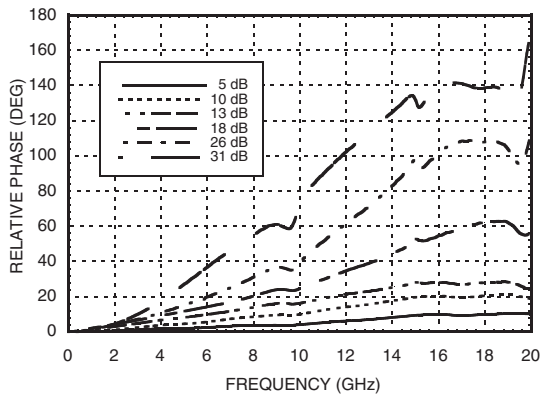

**Input IP3 vs.
Frequency Over Attenuation**

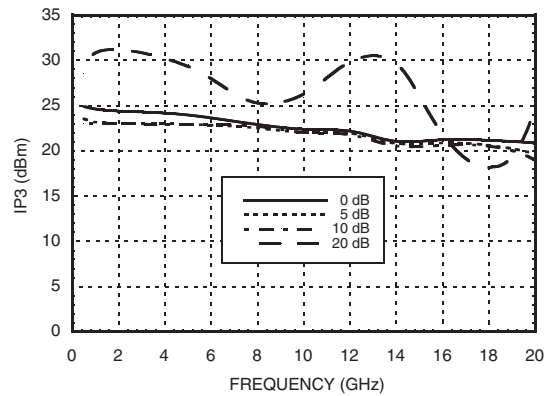



**VOLTAGE VARIABLE ATTENUATOR
MODULE, DC - 20 GHz**

**0.25 dB Compression vs.
Frequency Over Attenuation**

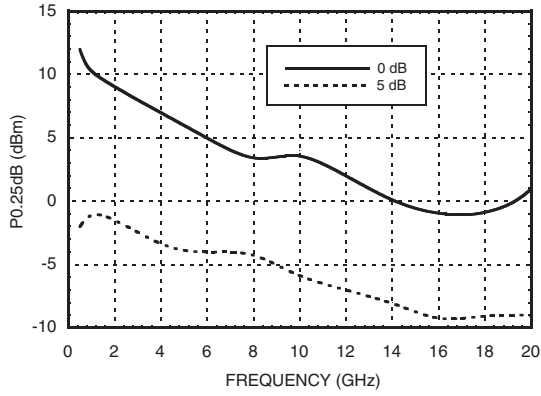

**1 dB Compression vs.
Frequency Over Attenuation**

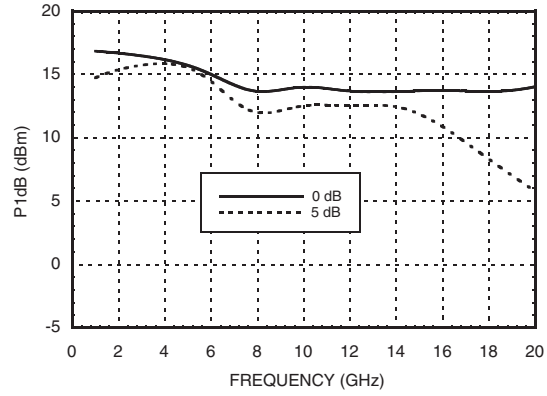

**VOLTAGE VARIABLE ATTENUATOR
MODULE, DC - 20 GHz**
Absolute Maximum Ratings

Control Voltage (Vctl)	+1 to -5 Vdc
Bias Voltage (Vdc / -Vdc)	+16V / -16V Vdc
RF Input Power (0.5 - 20 GHz)	+18 dBm
Storage Temperature	-65 to + 150 °C
Operating Temperature	-55 to +85 °C

Bias Voltage & Current

Vdc Range= ± 10%		
+Vdc / -Vdc	Idc (Typ.) (mA)	Idc (Max.) (mA)
5.0	3.3	3.7
-5.0	-6.9	-8.8



**ELECTROSTATIC SENSITIVE DEVICE
OBSERVE HANDLING PRECAUTIONS**

Control Voltage

State	Bias Condition (Vctl)
Min Atten	0V
Max Atten	-2.9V

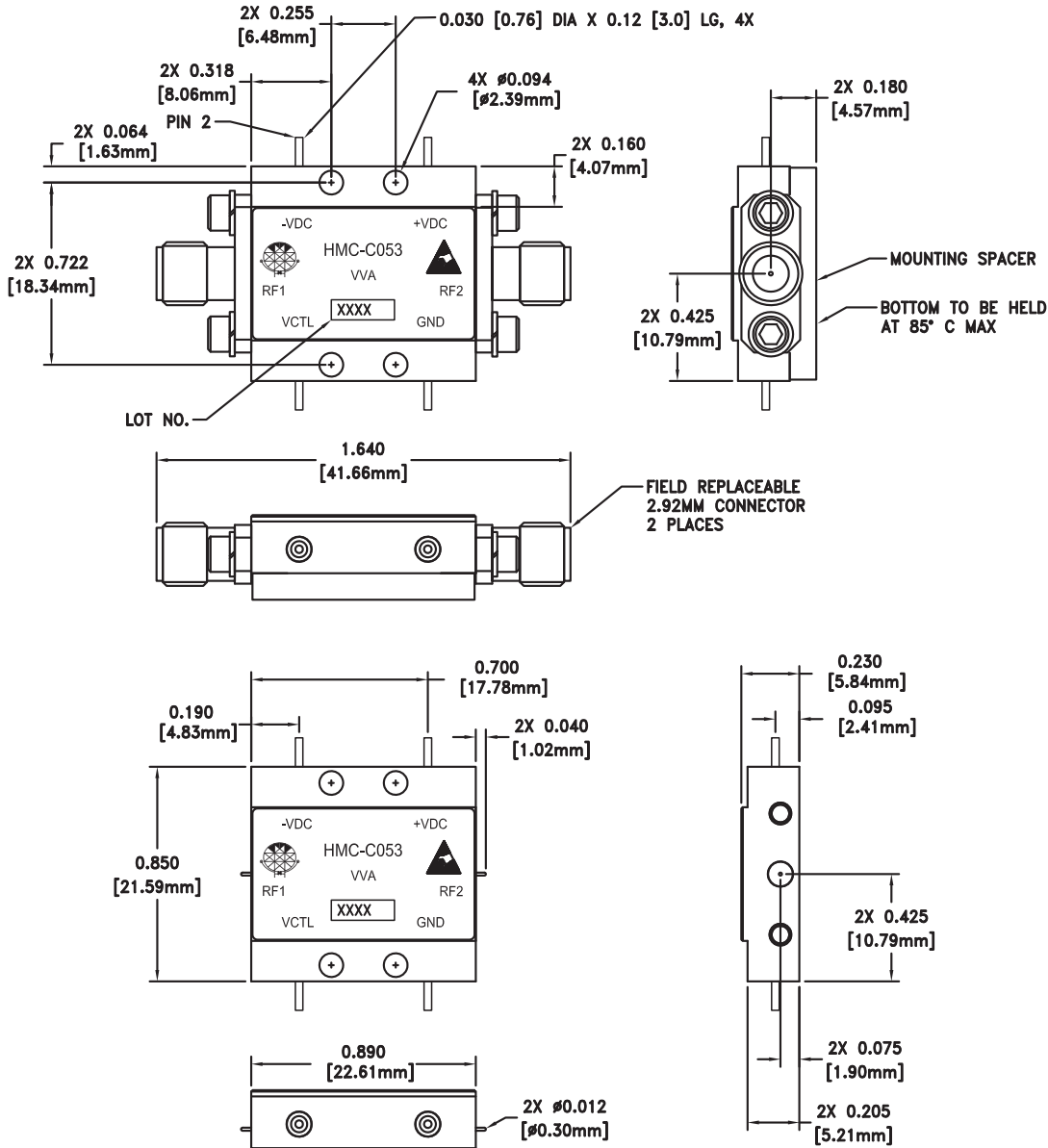
**VOLTAGE VARIABLE ATTENUATOR
MODULE, DC - 20 GHz**
Outline Drawing

Package Information

Package Type	C-10
Package Weight ^[1]	18.7 gms ^[2]
Spacer Weight	3.3 gms ^[2]

[1] Includes the connectors

[2] \pm 1 gms Tolerance



NOTES:

- PACKAGE, LEADS, COVER MATERIAL: KOVAR™
- SPACER MATERIAL: ALUMINUM
- PLATING: ELECTROLYTIC GOLD 50 MICROINCHES MIN., OVER ELECTROLYTIC NICKEL 75 MICROINCHES MIN.
- ALL DIMENSIONS ARE IN INCHES [MILLIMETERS].
- TOLERANCES \pm .005 [0.13] UNLESS OTHERWISE SPECIFIED.
- FIELD REPLACEABLE SMA CONNECTORS. TENSOLITE 5602 - 5CCSF OR EQUIVALENT.
- MOUNT MODULE TO SYSTEM PLATFORM WITH #2-56 HARDWARE

**VOLTAGE VARIABLE ATTENUATOR
MODULE, DC - 20 GHz**

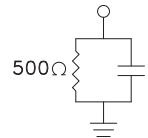

www.datasheet4u.com
Pin Description

Pin Number	Function	Description	Interface Schematic
1, 4	RF1, RF2	This pin is DC coupled and matched to 50 Ohm. Blocking capacitors are required if the RF line potential is not equal to 0V.	
2	Vctl	Control Input (Master).	
3	GND	Package bottom has exposed metal paddle that must also be connected to PCB RF ground.	
5, 6	-Vdc, +Vdc	Supply Voltages	