

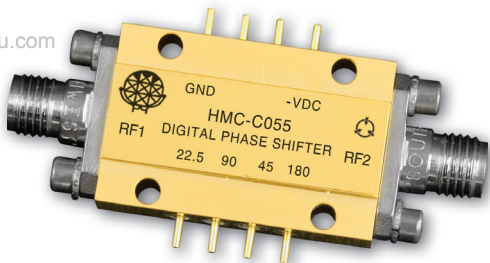

22.5° MMIC 4-BIT DIGITAL PHASE SHIFTER MODULE, 8 - 12 GHz

www.datasheet4u.com



Features

- Low RMS Phase Error: 6°
- Low Insertion Loss: 7 dB
- Excellent Flatness
- 360° Coverage, LSB = 22.5°
- Hermetically Sealed Module
- Field Replaceable SMA Female Connectors

Typical Applications

The HMC-C055 is ideal for:

- EW Receivers
- Weather & Military Radar
- Satellite Communications
- Beamforming Modules

Functional Diagram

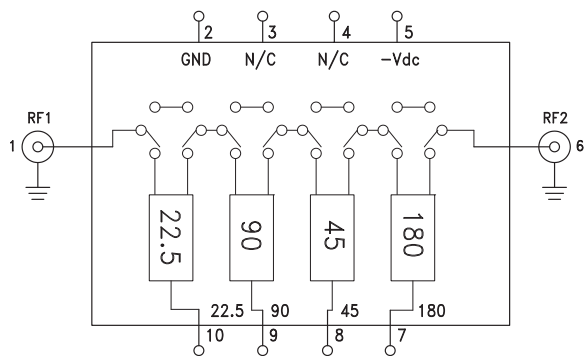

General Description

The HMC-C055 is a 4-bit digital phase shifter which is rated from 8 to 12 GHz, providing 0 to 360 degrees of monotonic phase coverage, with a LSB of 22.5 degrees. The HMC-C055 features a very low RMS phase error of 6 degrees and a low insertion loss variation of ± 1 dB across all phase states. This high accuracy phase shifter is controlled with TTL logic levels (0/+5V), requires a single DC voltage of -5V and is internally matched to 50 Ohms. The package is a hermetically sealed module that can utilize field replaceable SMA connectors or be used as a drop-in module.

Electrical Specifications, $T_A = +25^\circ \text{C}$, 50 Ohm System, Control Voltage = 0/+5V, -Vdc = -5V

Parameter	Min.	Typ.	Max.	Units
Frequency Range	8		12	GHz
Insertion Loss*		7	8.5	dB
Input Return Loss*		10		dB
Output Return Loss*		8		dB
Phase Error*		± 10	± 17	deg
RMS Phase Error		6		deg
Gain Variation*		± 1		dB
Input Power for 1 dB Compression		24		dBm
Input Third Order Intercept		38		dBm
Control Voltage Current		2.5		mA

*Note: All States Shown



22.5° MMIC 4-BIT DIGITAL PHASE SHIFTER MODULE, 8 - 12 GHz

www.datasheet4u.com

Insertion Loss, All States

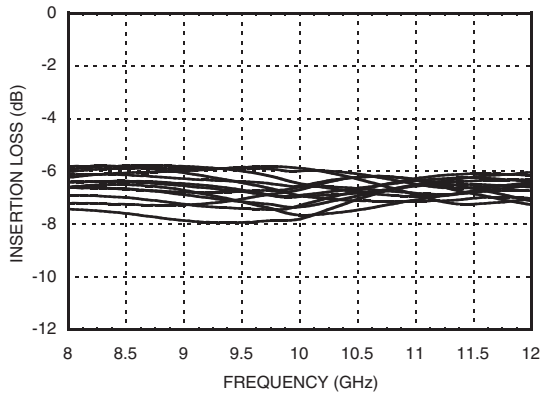

Normalized Loss, All States

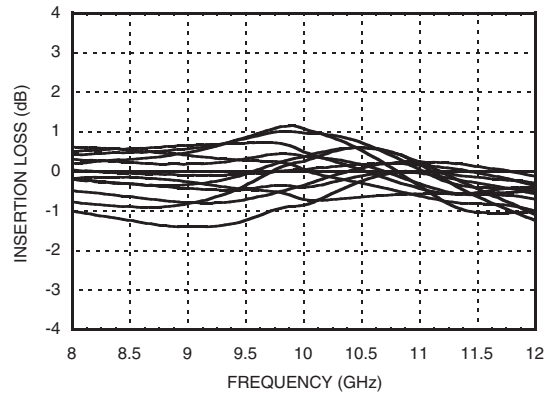

Input Return Loss, All States

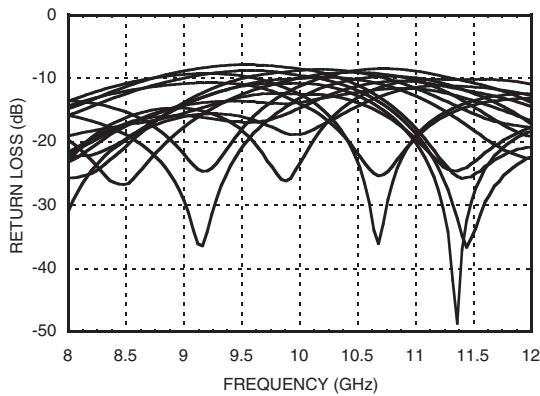

Phase Error, All States

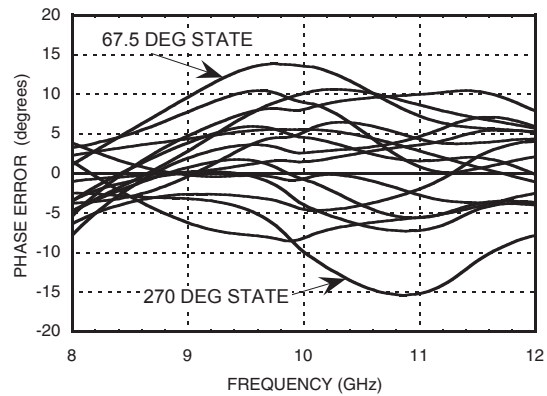

Output Return Loss, All States

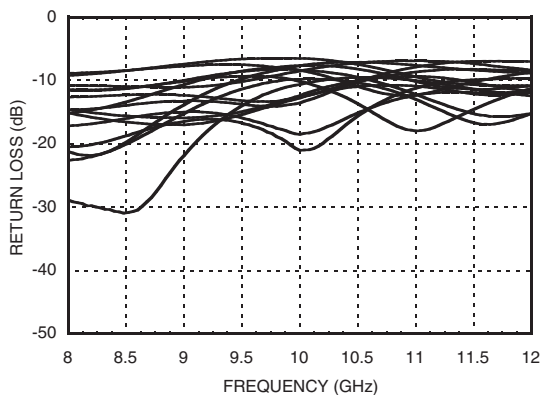

Relative Phase Shift, All States

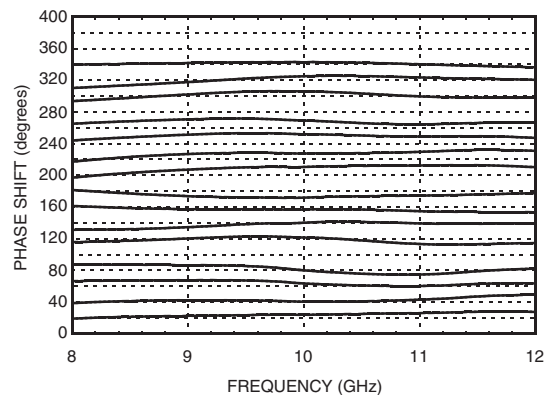



22.5° MMIC 4-BIT DIGITAL PHASE SHIFTER MODULE, 8 - 12 GHz

Relative Phase Shift, RMS, Average, Max, All States

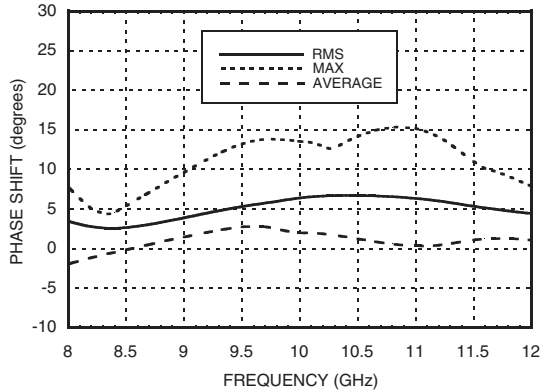

Input IP3, All States

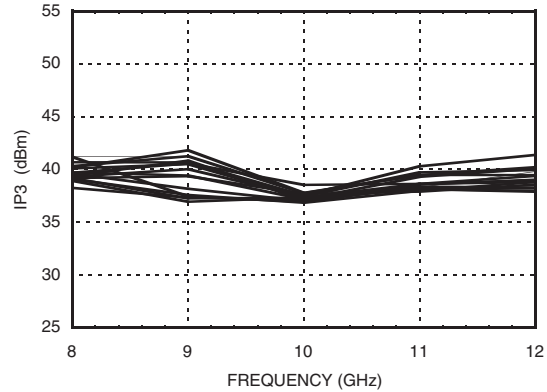

Input IP2, All States

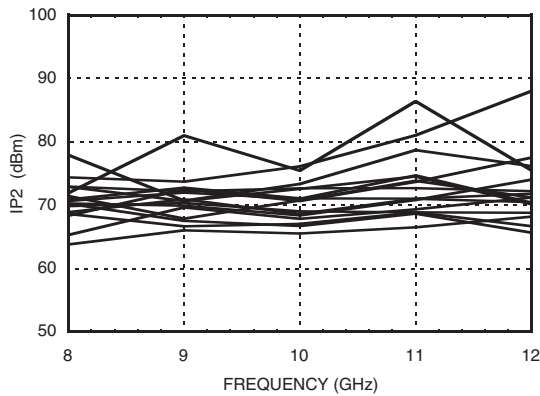

Input P1dB, All States

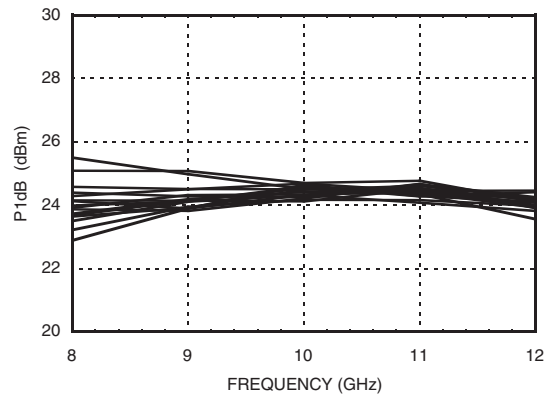

RMS Phase Error vs. Temperature

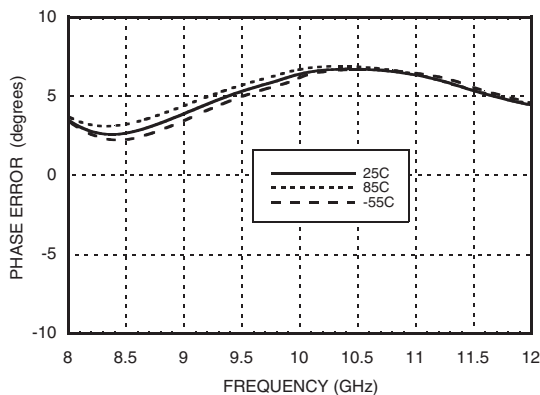

Insertion Loss vs. Temperature All States

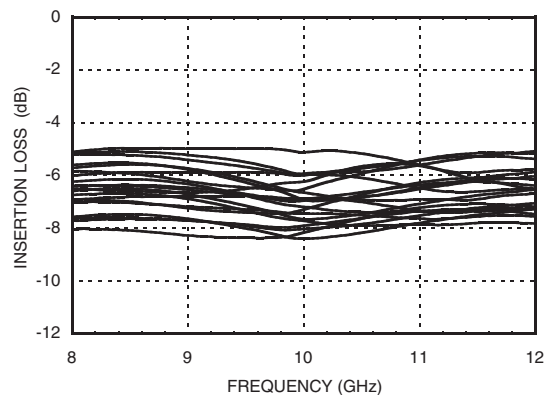



22.5° MMIC 4-BIT DIGITAL PHASE SHIFTER MODULE, 8 - 12 GHz

www.datasheet4u.com

Phase Error vs. State

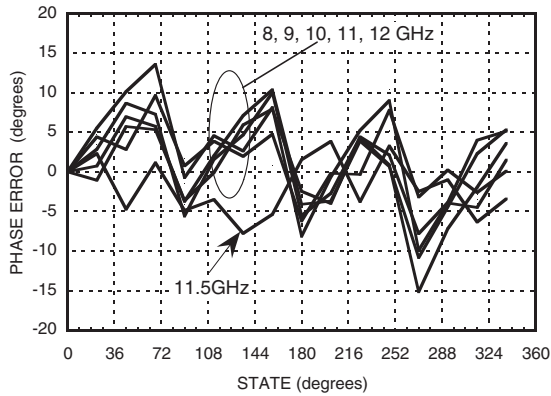

Absolute Maximum Ratings

Input Power (RF1, RF2) (8-12 GHz)	+27 dBm (T= +85 °C)
Channel Temperature (Tc)	150 °C
Supply Voltage (-Vdc)	-5.5V
Control Voltage	5.5V
Storage Temperature	-65 to +150 °C
Operating Temperature	-40 to +85 °C

Truth Table

Control Voltage Input				Phase Shift (Degree) RFIN - RFOUT
22.5	45	90	180	
0	0	0	0	Reference
1	0	0	0	22.5
0	1	0	0	45
0	0	1	0	90
0	0	0	1	180
1	1	1	1	337.5

Any combination of the above states will provide a phase shift approximately equal to the sum of the bits selected.

Control Voltage

State	Bias Condition
Low (0)	0V
High (1)	+5V



**ELECTROSTATIC SENSITIVE DEVICE
OBSERVE HANDLING PRECAUTIONS**



22.5° MMIC 4-BIT DIGITAL PHASE SHIFTER MODULE, 8 - 12 GHz

Outline Drawing

www.datasheet4u.com

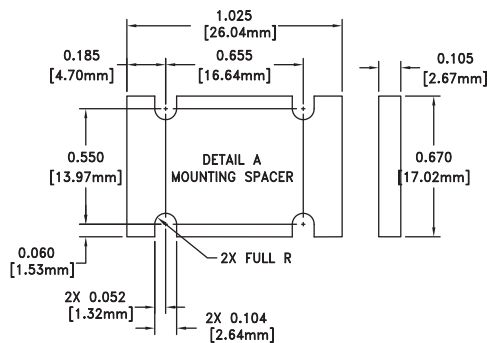
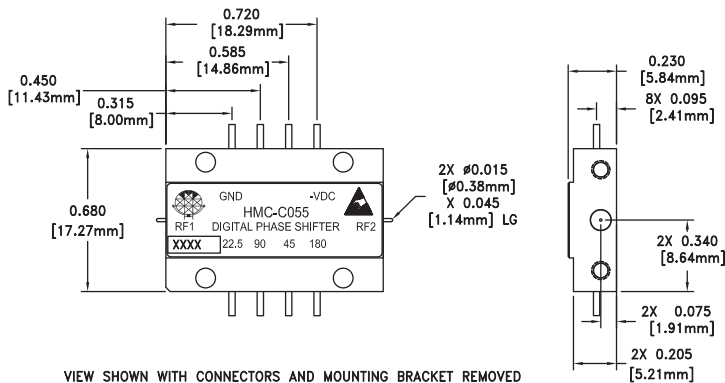
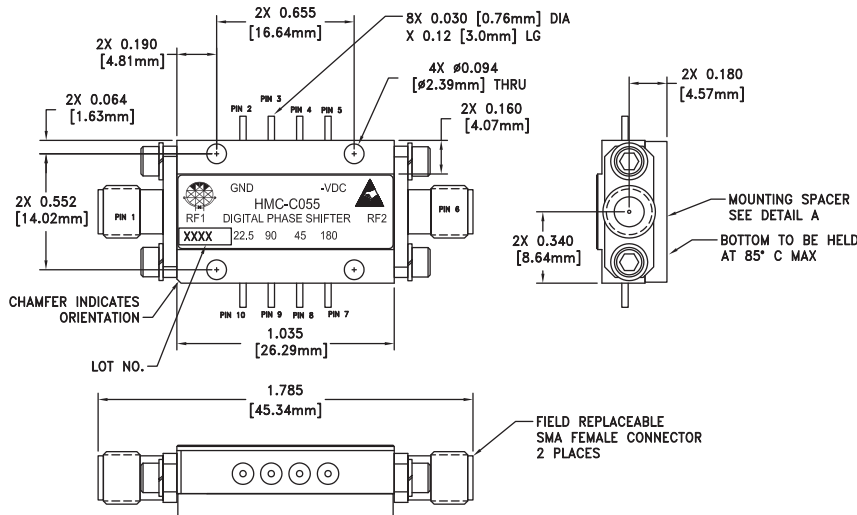

Package Information

Package Type	C-6
Package Weight [1]	17.4 gms [2]
Spacer Weight	3 gms [2]

[1] Includes the connectors

[2] \pm 1 gms Tolerance

NOTES:



1. PACKAGE, LEADS, COVER MATERIAL: KOVAR™
 2. SPACER MATERIAL: ALUMINUM
 3. PLATING: ELECTROLYTIC GOLD 50 MICROINCHES MIN., OVER ELECTROLYTIC NICKEL 75 MICROINCHES MIN.
 4. ALL DIMENSIONS ARE IN INCHES [MILLIMETERS].
 5. TOLERANCES \pm .005 [0.13] UNLESS OTHERWISE SPECIFIED.
 6. FIELD REPLACEABLE SMA CONNECTORS. TENSOLITE 5602 - 5CCSF OR EQUIVALENT.
- MOUNT MODULE TO SYSTEM PLATFORM WITH #2-56 HARDWARE

**22.5° MMIC 4-BIT DIGITAL
PHASE SHIFTER MODULE, 8 - 12 GHz**

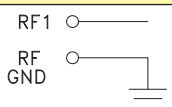

www.datasheet4u.com

Pin Descriptions

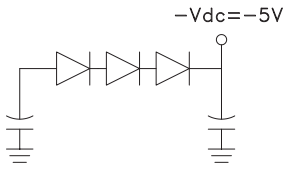
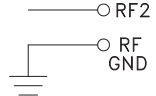
Pin Number	Function	Description	Interface Schematic
1	RF1 & RF Ground	RF input connector, coaxial female, field replaceable. This pin is AC coupled and matched to 50 Ohms.	
2	GND	This pin must be connected to RF/DC ground.	
3, 4	N/C	No connection required.	
5	-Vdc	-5V DC Voltage	
6	RF2 & RF Ground	RF input connector, coaxial female, field replaceable. This pin is AC coupled and matched to 50 Ohms.	
7 - 10	180, 45, 90, 22.5	Control voltage input. See truth table and control voltage tables.	