

FEATURES

High gain: 25 dB
High 1 dB compression (P1dB) output power: 29 dBm
High output third-order intercept (IP3): 42 dBm
Regulated supply and bias sequencing
SMA connectors
Operating temperature: -40°C to +70°C

APPLICATIONS

Telecommunications infrastructure
Test instrumentation
Military and space
Electronic warfare (EW)
Electronic countermeasures (ECM)
Radar
Test equipment

GENERAL DESCRIPTION

The [HMC-C075](#) is a two-stage power amplifier module that operates between 10 MHz and 6 GHz. The amplifier provides 25 dB of gain, 42 dBm of output IP3, and 29 dBm of output power at 1 dB gain compression, while consuming only 740 mA from a 15 V supply.

The [HMC-C075](#) is ideal for EW, ECM, radar, and test equipment applications

FUNCTIONAL BLOCK DIAGRAM

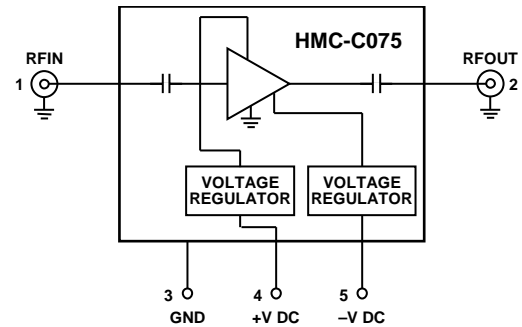

Figure 1.

The amplifier inputs/outputs (I/Os) are dc blocked and internally matched to 50 Ω . Integrated voltage regulators allow flexible biasing of both the negative and positive supply pins, while internal bias sequencing and active bias control allows robust operation and stable performance over temperature.

TABLE OF CONTENTS

Features	1	ESD Caution.....	4
Applications.....	1	Pin Configuration and Function Descriptions.....	5
Functional Block Diagram	1	Typical Performance Characteristics	6
General Description	1	Theory of Operation	8
Revision History	2	Applications information	9
Specifications.....	3	Outline Dimensions	10
Absolute Maximum Ratings.....	4	Ordering Guide	10

REVISION HISTORY

1/16—Revision C: Initial Version

SPECIFICATIONS

Bias voltages = +15 V and -5 V; baseplate temperature = 25°C, unless otherwise noted.

Table 1.

Parameter	Min	Typ	Max	Unit	Test Conditions/Comments
FREQUENCY RANGE	0.01		6	GHz	
GAIN					
0.01 GHz to 1 GHz	21	25		dB	
1 GHz to 3 GHz	21	25		dB	
3 GHz to 6 GHz	18	23		dB	
GAIN FLATNESS		±3		dB	
GAIN VARIATION OVER TEMPERATURE		0.03		dB/°C	
NOISE FIGURE					
1 GHz to 3 GHz		8		dB	
3 GHz to 6 GHz		5		dB	
1 dB COMPRESSION (P1dB)					
0.01 GHz to 1 GHz	24	28		dBm	
1 GHz to 3 GHz	27	30		dBm	
3 GHz to 6 GHz	26	29		dBm	
OUTPUT THIRD-ORDER INTERCEPT (IP3)					
0.01 GHz to 1 GHz		42		dBm	
1 GHz to 3 GHz		43		dBm	
3 GHz to 6 GHz		41		dBm	
SATURATED OUTPUT POWER (P _{SAT})		30		dBm	
RETURN LOSS					
Input		-12		dB	
Output		-14		dB	
SUPPLY INPUT					
+V DC		15		V	
-V DC		-5		V	
CURRENT					
+V DC		740	900	mA	+V DC = +15 V, -V DC = -5 V
-V DC		5	10	mA	

ABSOLUTE MAXIMUM RATINGS

Table 2.

Parameter	Rating
15 V Bias Line	16 V
-5 V Bias Line	-16 V
Radio Frequency (RF) Input Level	10 dBm
Operating Temperature Range	-40°C to +70°C
Storage Temperature Range	-55°C to +150°C
ESD Sensitivity, Human Body Model (HBM)	Class IA
Thermal Resistance	5.9°C/W

Stresses at or above those listed under Absolute Maximum Ratings may cause permanent damage to the product. This is a stress rating only; functional operation of the product at these or any other conditions above those indicated in the operational section of this specification is not implied. Operation beyond the maximum operating conditions for extended periods may affect product reliability.

ESD CAUTION



ESD (electrostatic discharge) sensitive device. Charged devices and circuit boards can discharge without detection. Although this product features patented or proprietary protection circuitry, damage may occur on devices subjected to high energy ESD. Therefore, proper ESD precautions should be taken to avoid performance degradation or loss of functionality.

PIN CONFIGURATION AND FUNCTION DESCRIPTIONS

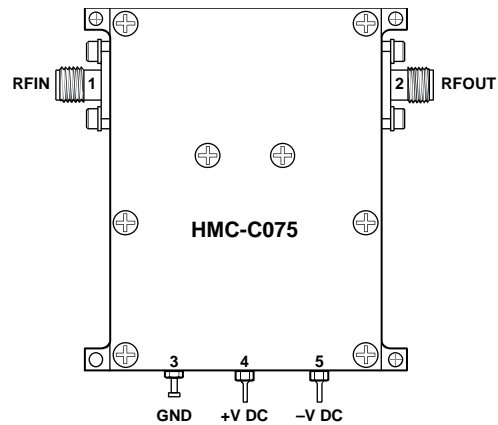

Figure 2. Pin Configuration

Table 3. Pin Function Descriptions

Pin No.	Mnemonic	Description
1	RFIN	RF Input Connector, SMA Female, Field Replaceable. This pin is ac-coupled and matched to 50 Ω .
2	RFOUT	RF Output Connector, SMA Female, Field Replaceable. This pin is ac-coupled and matched to 50 Ω .
3	GND	Power Supply Ground.
4	+V DC	Positive Supply Voltage, 14 V to 16 V.
5	-V DC	Negative Supply Voltage, -5 V to -16 V.

TYPICAL PERFORMANCE CHARACTERISTICS

Bias voltages = +15 V and -5 V; baseplate temperature = 25°C, unless otherwise noted.

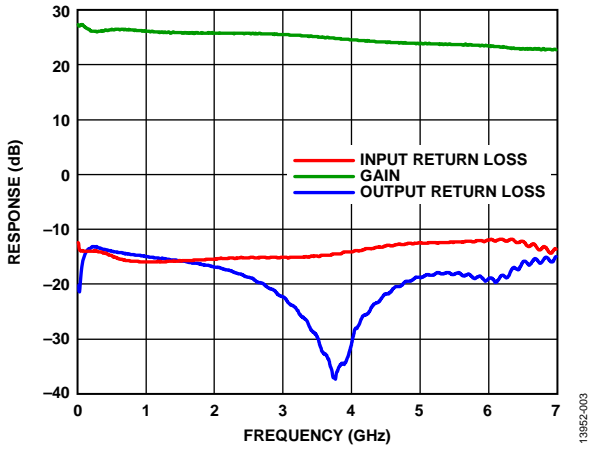

Figure 3. Gain and Input/Output Return Loss vs. Frequency

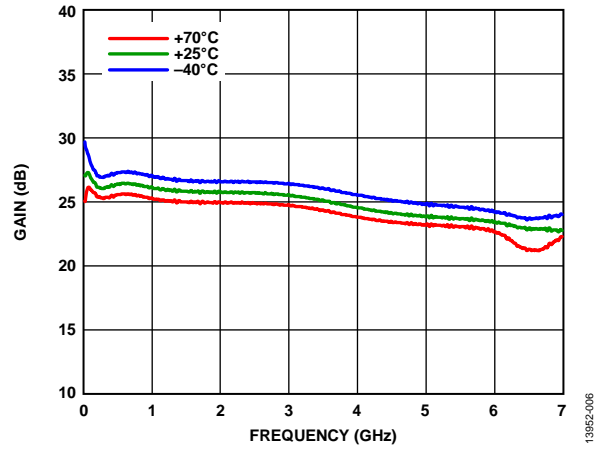

Figure 6. Gain vs. Frequency for Various Temperatures

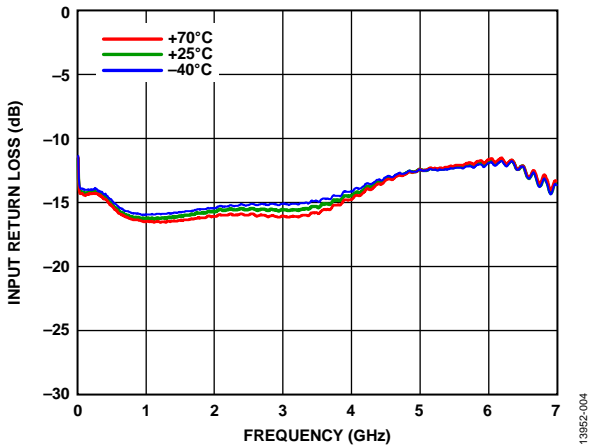

Figure 4. Input Return Loss vs. Frequency for Various Temperatures

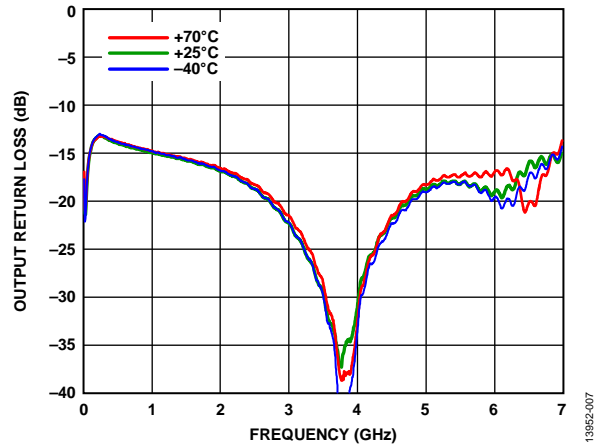

Figure 7. Output Return Loss vs. Frequency for Various Temperatures

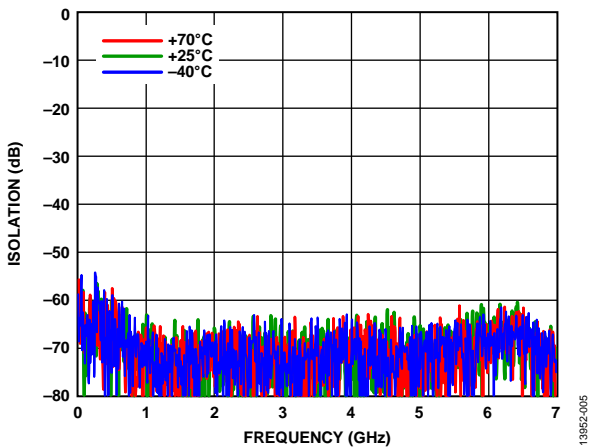

Figure 5. Isolation vs. Frequency for Various Temperatures

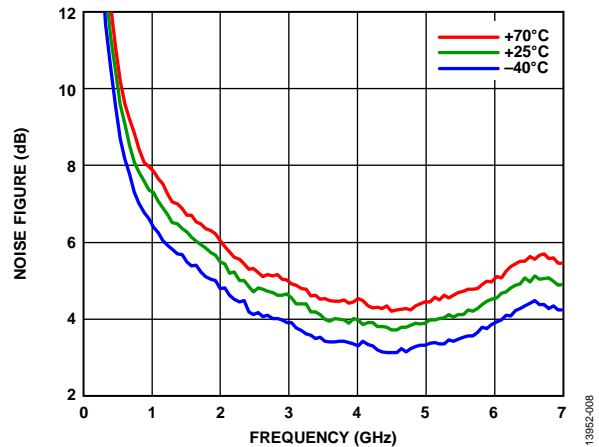

Figure 8. Noise Figure vs. Frequency for Various Temperatures

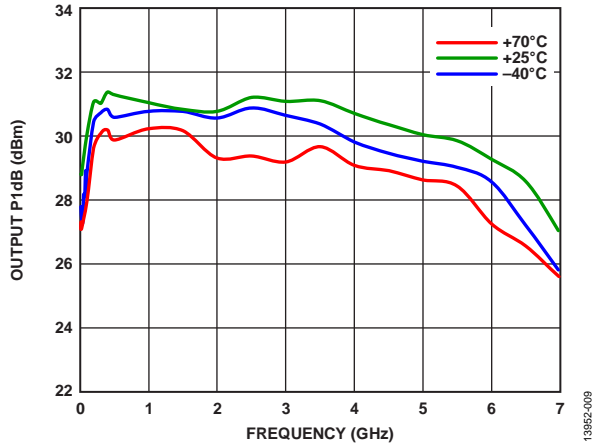

Figure 9. Output P1dB vs. Frequency for Various Temperatures

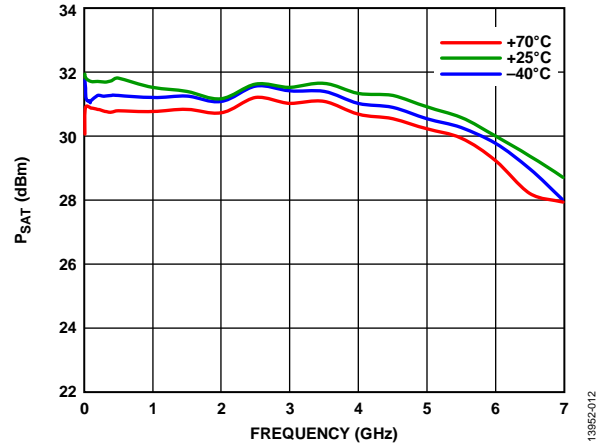

Figure 12. P_{SAT} vs. Frequency for Various Temperatures

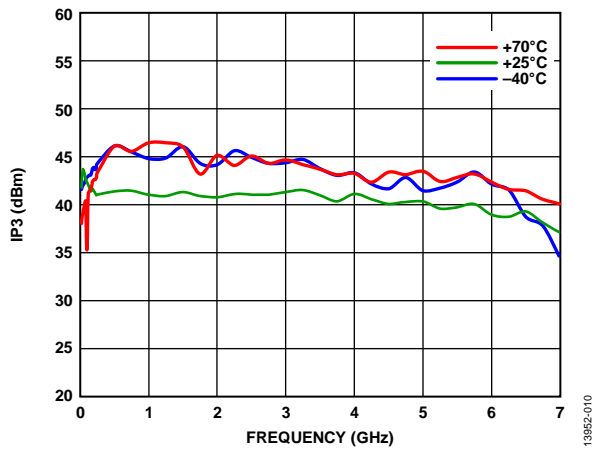

Figure 10. IP_3 vs. Frequency for Various Temperatures

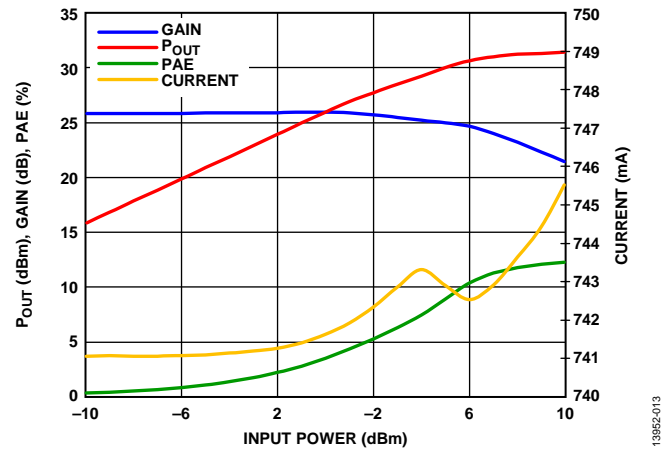

Figure 13. Output Power (P_{OUT}), Gain, and Power Added Efficiency (PAE) vs. Input Power

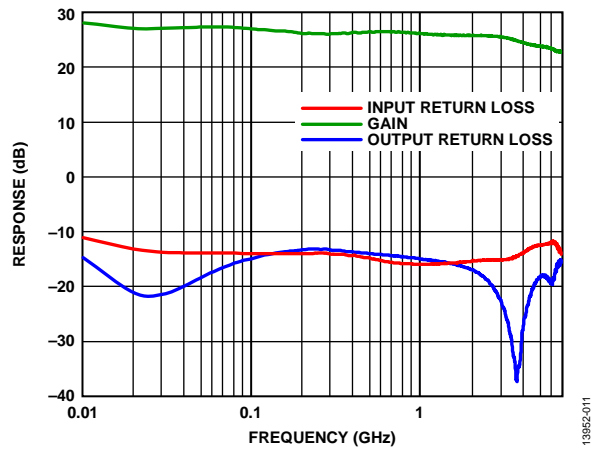

Figure 11. Gain, Input Return Loss, and Output Return Loss vs. Frequency

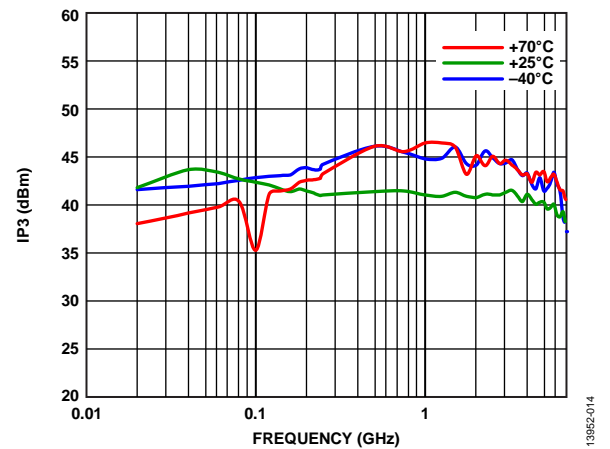

Figure 14. Output IP_3 vs. Frequency

THEORY OF OPERATION

The [HMC-C075](#) package contains four mounting locations for screws to secure the amplifier package in dynamic applications and for thermal contact. Attach the amplifier to a heat sink of a suitable size such that, during operation, the backside case temperature never exceeds 70°C. Operation of the device at backside case temperatures greater than 70°C results in reduced life of the device.

Prior to applying dc voltages, terminate both the RF input and the RF output to 50 Ω . Never disconnect the RF output when dc voltages are applied to the device.

APPLICATIONS INFORMATION

The [HMC-C075](#) is a connectorized amplifier module designed with two stage amplifiers to deliver 29 dBm of typical power with a 25 dB gain from 0.01 GHz to 6 GHz. The bias of the internal amplifiers is supplied by 15 V and -5 V dc sources that power internal voltage regulators. The [HMC-C075](#) features built-in bias sequencing and active bias control to prevent damage to the amplifiers and to maintain stable gain over temperature.

The [HMC-C075](#) is built in a miniature module with SMA connectors for RF input and output, and robust feedthroughs for bias and ground return.

To turn on the amplifier, complete the following steps:

1. Verify that the dc connections are correct.
2. Verify that the RF input power is off.
3. Apply -V DC to the supply pin.
4. Apply +V DC to the supply pin.
5. Apply the RF input, ensuring that the power level is correct.

To turn off the amplifier, complete the following steps:

1. Turn the RF input off.
2. Turn off the +V DC supply.
3. Turn off the -V DC supply.

OUTLINE DIMENSIONS

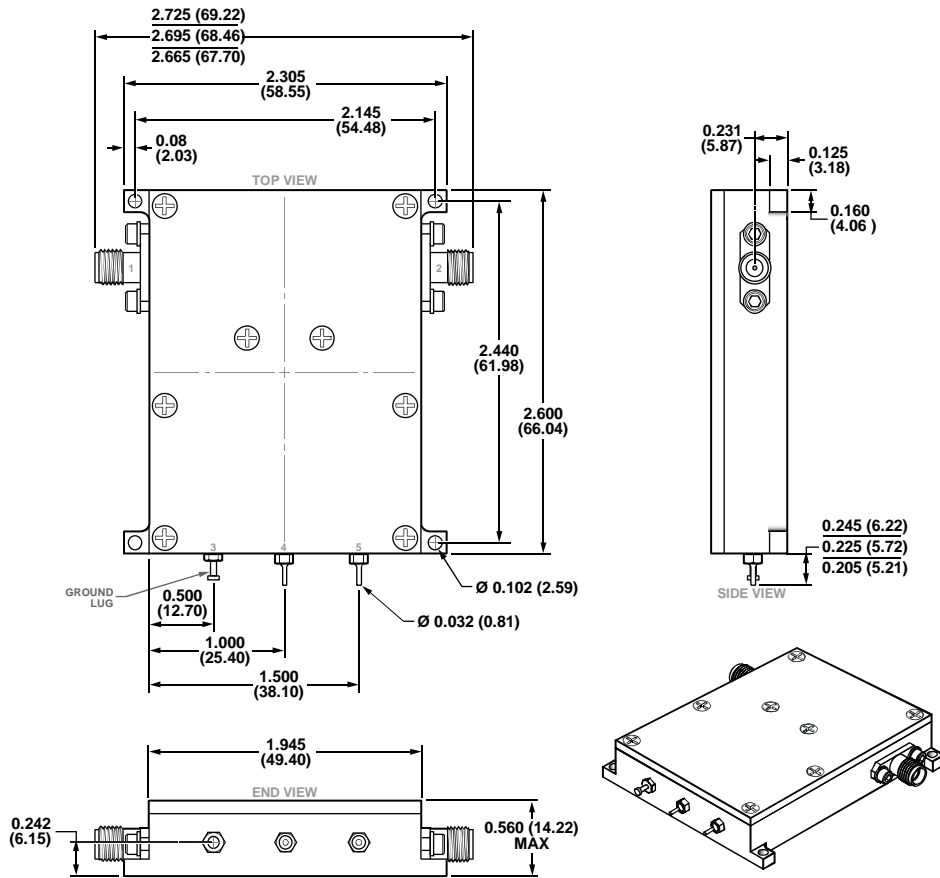

CONTROLLING DIMENSIONS ARE IN INCHES; MILLIMETER DIMENSIONS (IN PARENTHESES) ARE ROUNDED-OFF INCH EQUIVALENTS FOR REFERENCE ONLY AND ARE NOT APPROPRIATE FOR USE IN DESIGN.

Figure 15. 5-Lead Module with Connector Interface [MODULE] (ML-5-2)

Dimensions shown in inches and (millimeters)

ORDERING GUIDE

Model	Temperature Range	Package Description	Package Option
HMC-C075	-40°C to +70°C	5-Lead Module with Connector Interface [MODULE]	ML-5-2