

GaAs pHEMT MMIC 0.25 WATT POWER AMPLIFIER, DC - 48 GHz

Typical Applications

The HMC1022A is ideal for:

- Test Instrumentation
- Microwave Radio & VSAT
- Military & Space
- Telecom Infrastructure
- Fiber Optics

Features

- High P1dB Output Power: 22 dBm
- High Psat Output Power: 24 dBm
- High Gain: 12 dB
- High Output IP3: 32 dBm
- Supply Voltage: +10 V @ 150 mA
- 50 Ohm Matched Input/Output
- Die Size: 2.82 x 1.50 x 0.1 mm

Functional Diagram

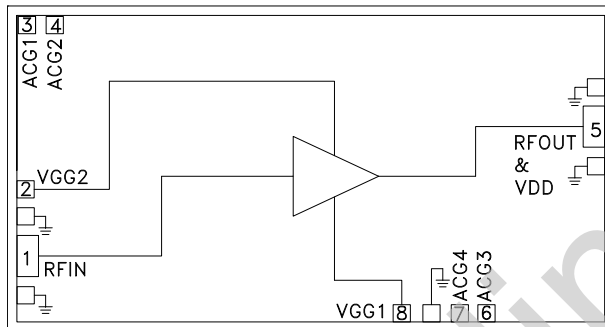

General Description

The HMC1022A is a GaAs pHEMT MMIC Distributed Power Amplifier which operates between DC and 48 GHz. The amplifier provides 12 dB of gain, 32 dBm output IP3 and +22 dBm of output power at 1 dB gain compression while requiring 150 mA from a +10 V supply. The HMC1022A exhibits a slightly positive gain slope from 10 to 35 GHz, making it ideal for EW, ECM, Radar and test equipment applications. The HMC1022A amplifier I/Os are internally matched to 50 Ohms facilitating integration into Multi-Chip-Modules (MCMs). All data is taken with the chip connected via two 0.025 mm (1 mil) wire bonds of minimal length 0.31 mm (12 mils).

Electrical Specifications, $T_A = +25^\circ\text{C}$, $V_{dd} = +10\text{V}$, $V_{gg2} = +4.5\text{V}$, $I_{dd} = 150\text{mA}$ [1]

Parameter	Min.	Typ.	Max.	Min.	Typ.	Max.	Min.	Typ.	Max.	Units
Frequency Range	DC - 16			16 - 36			36 - 48			GHz
Gain	9.5	11.5		9.5	12		9.5	11.5		dB
Gain Flatness		±0.5			±0.3			±1.1		dB
Gain Variation Over Temperature		0.012			0.018			0.041		dB/°C
Input Return Loss		18			16			15		dB
Output Return Loss		28			22			18		dB
Output Power for 1 dB Compression (P1dB)	20	22		19.5	21.5		16	19		dBm
Saturated Output Power (Psat)		24.5			23.5			21		dBm
Output Third Order Intercept (IP3)		35			32			29		dBm
Noise Figure		4			5.5			8		dB
Supply Current (Idd) (Vdd= 10V, Vgg1= -0.8V Typ.)		150			150			150		mA

[1] Adjust Vgg1 between -2 to 0 V to achieve Idd = 150 mA typical.

GaAs pHEMT MMIC 0.25 WATT POWER AMPLIFIER, DC - 48 GHz

Pad Descriptions

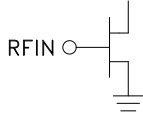
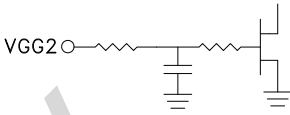
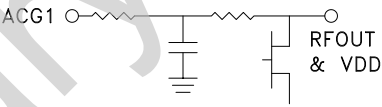
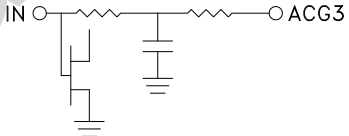
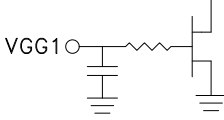
Pad Number	Function	Description	Interface Schematic
1	RFIN	This pad is DC coupled and matched to 50 Ohms. Blocking capacitor is required.	
2	VGG2	Gate control 2 for amplifier. Attach bypass capacitor per application circuit herein. For nominal operation +4.5V should be applied to Vgg2.	
4, 7	ACG2, ACG4	Low frequency termination. Attach bypass capacitor per application circuit herein.	
3	ACG1	Low frequency termination. Attach bypass capacitor per application circuit herein.	
5	RFOUT & VDD	RF output for amplifier. Connect DC bias (Vdd) network to provide drain current (Idd). See application circuit herein.	
6	ACG3	Low frequency termination. Attach bypass capacitor per application circuit herein.	
8	VGG1	Gate control 1 for amplifier. Attach bypass capacitor per application circuit herein. Please follow "MMIC Amplifier Biasing Procedure" application note.	
Die Bottom	GND	Die bottom must be connected to RF/DC ground.	

**GaAs pHEMT MMIC
0.25 WATT POWER AMPLIFIER, DC - 48 GHz**

Outline Drawing

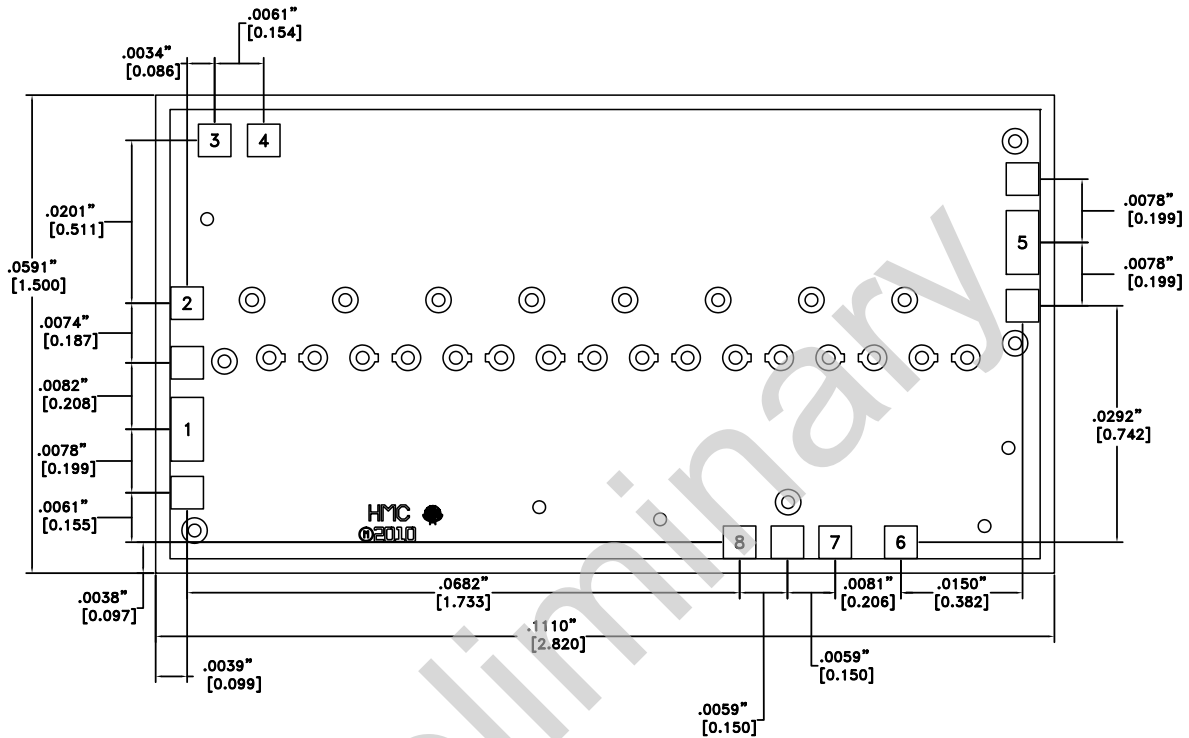

Die Packaging Information [1]

Standard	Alternate
GP-1 (Gel Pack)	[2]

[1] Refer to the "Packaging Information" section for die packaging dimensions.

[2] For alternate packaging information contact Hittite Microwave Corporation.

NOTES:

1. ALL DIMENSIONS IN INCHES [MILLIMETERS]
2. DIE THICKNESS IS 0.004 (0.100)
3. TYPICAL BOND PAD IS 0.004 (0.100) SQUARE
4. BOND PAD METALLIZATION: GOLD
5. BACKSIDE METALLIZATION: GOLD
6. BACKSIDE METAL IS GROUND
7. NO CONNECTION REQUIRED FOR UNLABELED BOND PADS
8. OVERALL DIE SIZE IS ±.002