



GaAs MMIC SP4T REFLECTIVE SWITCH 23 - 30 GHz

Typical Applications

The HMC1084LC4 is ideal for:

- Telecom Infrastructure
- Microwave Radio & VSAT
- Military & Space Hybrids
- Test Instrumentation
- SATCOM & Sensors

Functional Diagram

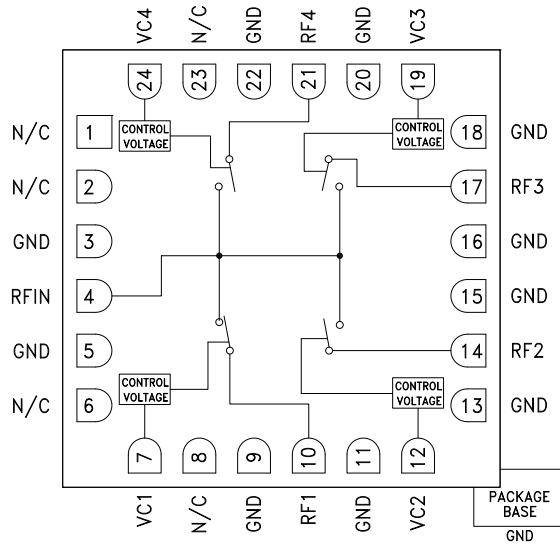

Features

- Broadband Performance: 23 - 30 GHz
- High Isolation: 26 dB
- Insertion Loss: 2.8 dB
- High Power Handling: >27 dBm
- 24 Lead 4x4mm SMT Package: 16mm²

General Description

The HMC1084LC4 is a broadband reflective GaAs MESFET SP4T switch in a compact 4x4 mm ceramic package. Covering 23 - 30 GHz, this switch offers high isolation and low insertion loss. The HMC1084LC4 is controlled with 0/-3V logic, exhibits fast switching speed and consumes much less DC current than pin diode based solutions. With its compact form factor, the HMC1084LC4 is ideal for microwave radio as well as SATCOM and sensor applications. The HMC1084LC4 is housed in a leadless 4x4 mm SMT package which is compatible with surface mount manufacturing techniques.

Electrical Specifications, $T_A = +25^\circ\text{C}$, With 0/-3V Control, 50 Ohm System

Parameter		Frequency	Min.	Typ.	Max.	Units
Insertion Loss	(RFC to RF1)	23 - 26 GHz		3.2	3.9	dB
	(RFC to RF2)			3.6	4.3	dB
	(RFC to RF3)			3.6	4.3	dB
	(RFC to RF4)			3.8	4.5	dB
Insertion Loss	(RFC to RF1)	26 - 30 GHz		2.8	3.5	dB
	(RFC to RF2)			2.8	3.5	dB
	(RFC to RF3)			2.8	3.4	dB
	(RFC to RF4)			3.3	4.0	dB
Isolation	(RFC to RF1, RF4)	23 - 30 GHz	21	26		dB
Isolation	(RFC to RF2, RF3)	23 - 30 GHz	21	26		
Return Loss [1]	"On State"	23 - 30 GHz		11		dB
Return Loss [2]	"Off State"	23 - 30 GHz		6		dB
Input Third Order Intercept (Two-Tone Input Power= 10 dBm Each Tone)		23 - 25 GHz		47		dBm
		25 - 30 GHz		43		
Switching Characteristics tRISE, tFALL (10/90% RF)		23 - 30 GHz		15		ns
	tON, tOFF (50% CTL to 10/90% RF)	23 - 30 GHz		53		ns

[1] Return loss with switch path in insertion loss state.

[2] Return loss with switch path in isolation state.

HMC1084* PRODUCT PAGE QUICK LINKS

Last Content Update: 02/23/2017

COMPARABLE PARTS

View a parametric search of comparable parts.

EVALUATION KITS

- HMC1084LC4 Evaluation Board

DOCUMENTATION

Data Sheet

- HMC1084 Data Sheet

TOOLS AND SIMULATIONS

- HMC1084 S-Parameters

REFERENCE MATERIALS

Quality Documentation

- Package/Assembly Qualification Test Report: LC3, LC3B, LC3C (QTR: 2014-00376 REV: 01)
- Semiconductor Qualification Test Report: PHEMT-J (QTR: 2013-00285)

DESIGN RESOURCES

- HMC1084 Material Declaration
- PCN-PDN Information
- Quality And Reliability
- Symbols and Footprints

DISCUSSIONS

View all HMC1084 EngineerZone Discussions.

SAMPLE AND BUY

Visit the product page to see pricing options.

TECHNICAL SUPPORT

Submit a technical question or find your regional support number.

DOCUMENT FEEDBACK

Submit feedback for this data sheet.



GaAs MMIC SP4T REFLECTIVE SWITCH 23 - 30 GHz

Insertion Loss RFIN to RF1 vs. Temperature

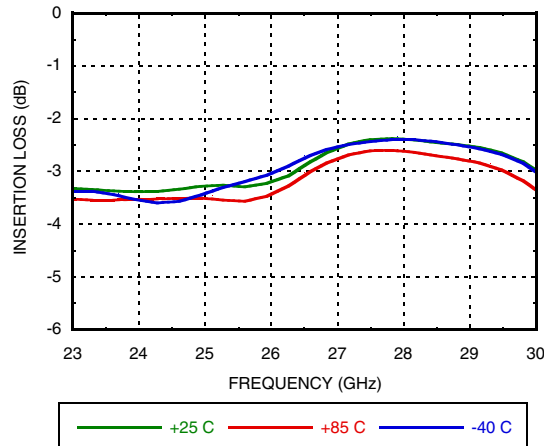

Insertion Loss RFIN to RF4 vs. Temperature

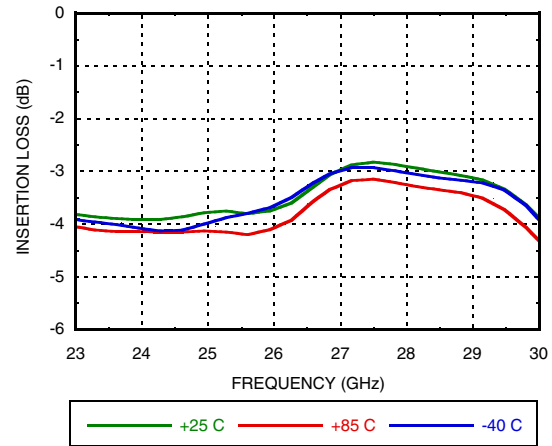

Insertion Loss RFIN to RF2 vs. Temperature

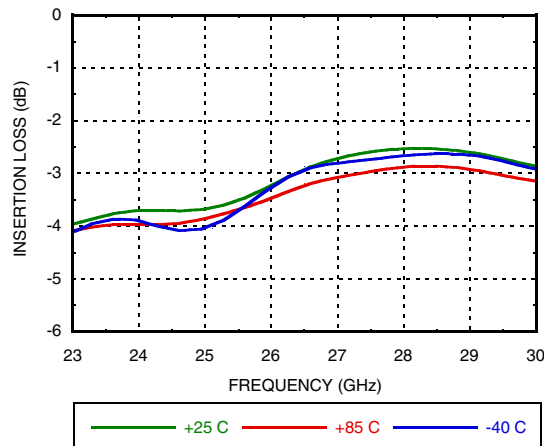

Insertion Loss RFIN to RF3 vs. Temperature

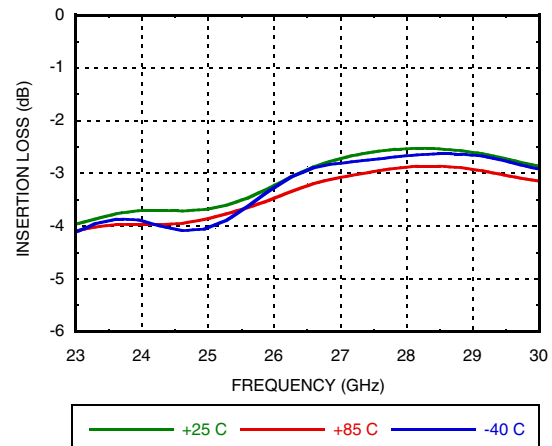

Isolation, Worst Case

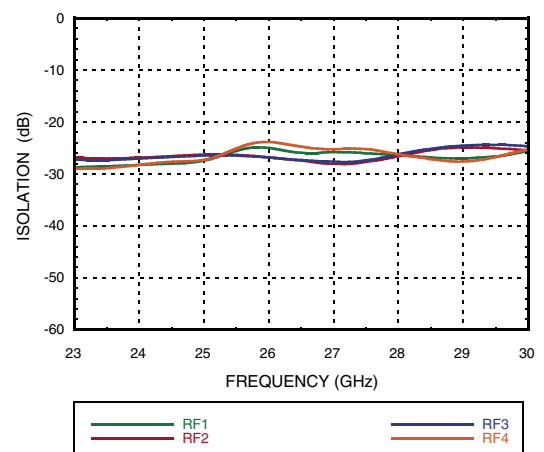

Return Loss On State [1]

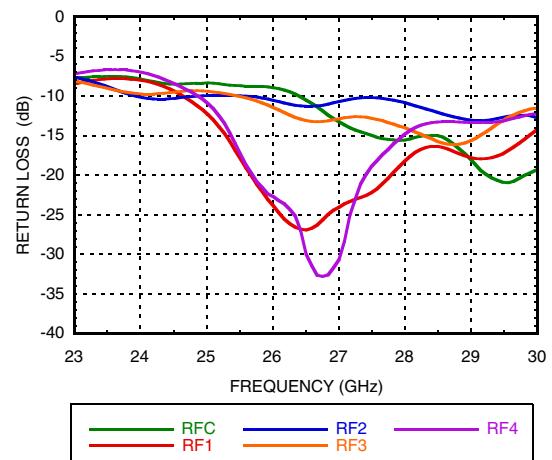

[1] Return loss with switch path in insertion loss state.



GaAs MMIC SP4T REFLECTIVE SWITCH 23 - 30 GHz

SWITCHES - SP4T - SMT

Return Loss Off State [1]

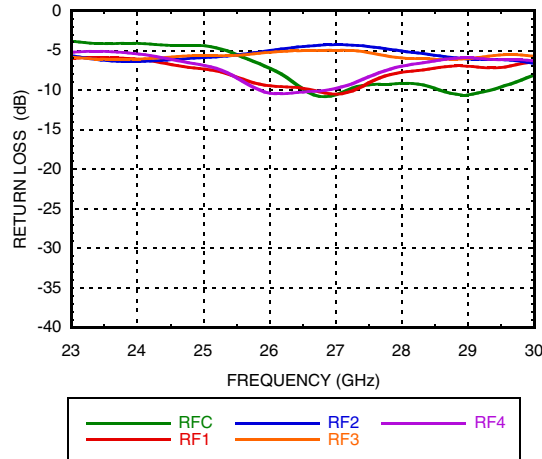

Insertion Loss vs. Input Power

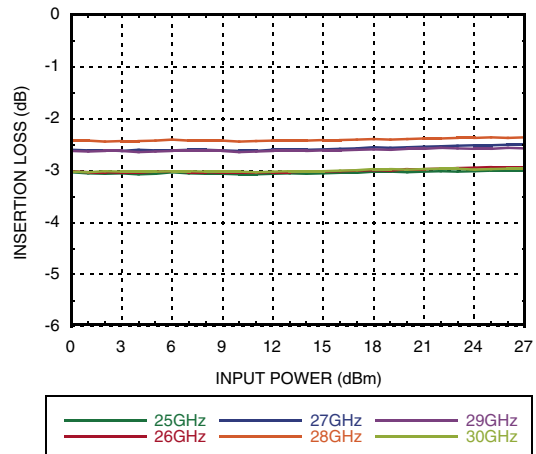

Input IP3 vs. Temperature @ 10dBm/tone

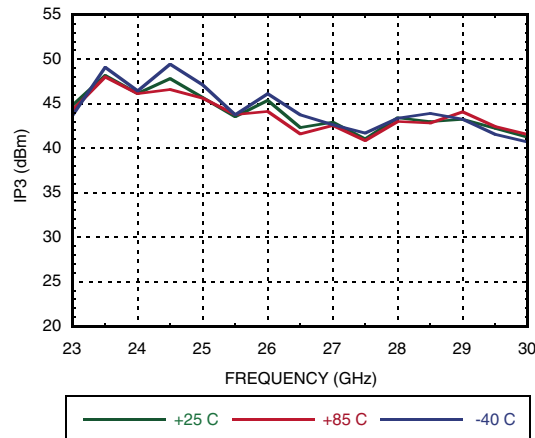

[1] Return loss with switch path in isolation state.

GaAs MMIC SP4T REFLECTIVE SWITCH 23 - 30 GHz



Absolute Maximum Ratings

Control Voltage Range (VC1, VC2, VC3, VC4)	+5V
Maximum Input Power	30 dBm
Channel Temperature	175 °C
Thermal Resistance Channel to die bottom (Insertion Loss Path)	24 °C/W
Storage Temperature	-65 to +150 °C
Operating Temperature	-55 to +85 °C
ESD Sensitivity (HBM)	Class1A

Bias Voltage & Current

VC (V)	IC (µA)
VC1 = -3V	IC1 < 10 µA
VC2 = -3V	IC2 < 10 µA
VC3 = -3V	IC3 < 10 µA
VC4 = -3V	IC4 < 10 µA

Truth Table

VC1	VC2	VC3	VC4	RFIN to:
-3V	0V	0V	0V	RF1
0V	-3V	0V	0V	RF2
0V	0V	-3V	0V	RF3
0V	0V	0V	-3V	RF4



ELECTROSTATIC SENSITIVE DEVICE
OBSERVE HANDLING PRECAUTIONS

Control Voltages

State	Bias Condition
Low	+1V to -0.25V
High	-2.75V to -5V, < 10 µA

Outline Drawing

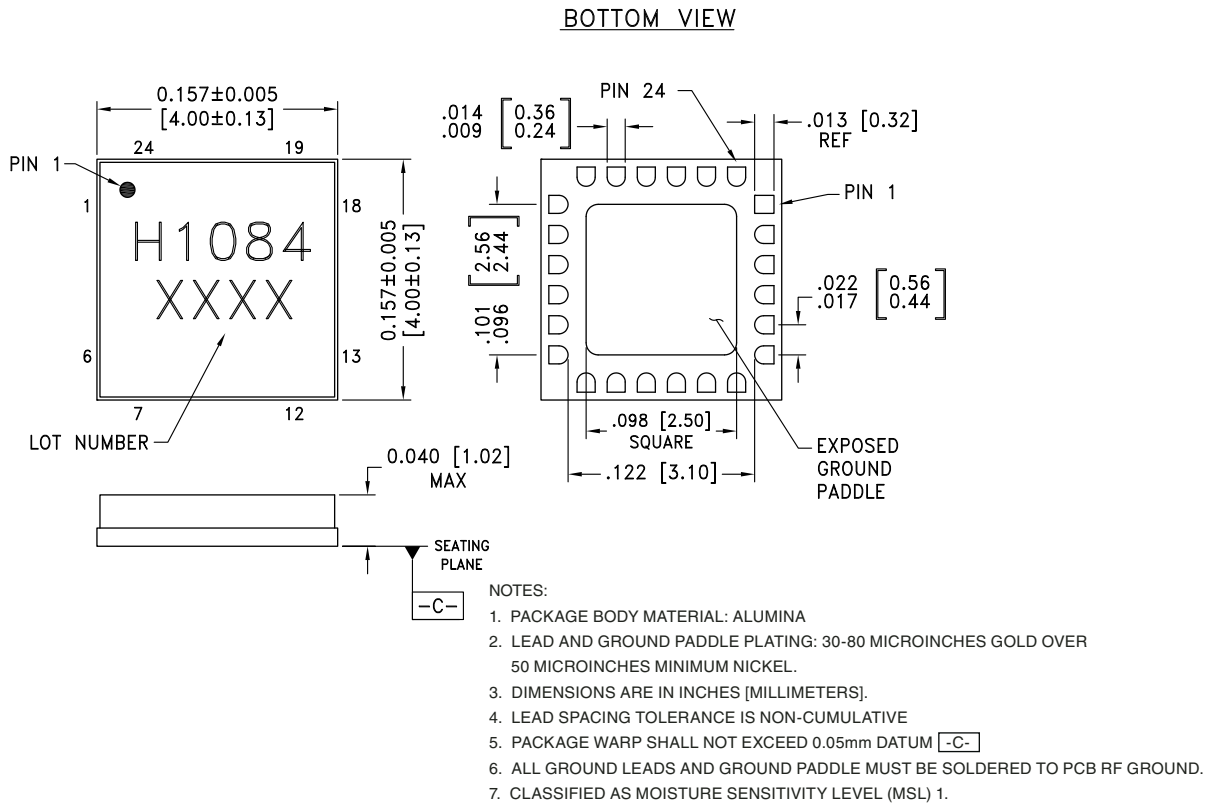



GaAs MMIC SP4T REFLECTIVE SWITCH 23 - 30 GHz

Pin Descriptions

Pin Number	Function	Description	Interface Schematic
1, 2, 6, 8, 23	N/C	These pins are not connected internally; however, all data shown herein was measured with these pins connected to RF/DC ground externally	
3, 5, 9, 11, 13, 15, 16, 18, 20, 22	GND	These pins and the exposed ground paddle must be connected to RF/DC ground.	
4, 10, 14, 17, 21	RFIN, RF1, RF2, RF3, RF4	These pins are DC coupled (to GND) and matched to 50 Ohms	
7, 12, 19, 24	VC1, VC2, VC3, VC4	See Truth Table	

Evaluation PCB

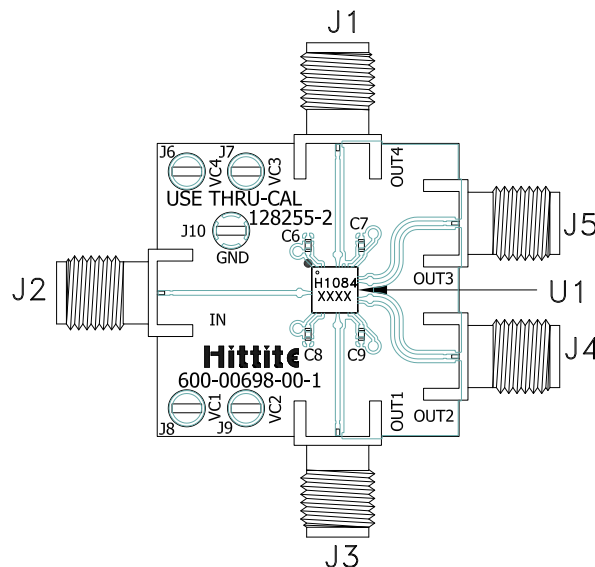

List of Materials for Evaluation PCB EVAL01-HMC1084LC4^[1]

Item	Description
J1 - J5	PCB Mount K connector
C6 - C9	1000pF Capacitor, 0402 Pkg.
U1	HMC1084LC4, Switch
PCB ^[2]	600-00698-00, Evaluation PCB

[1] Reference this number when ordering complete evaluation PCB

[2] Circuit Board Material: Rogers 4350 or Arlon FR4

The circuit board used in the application should use RF circuit design techniques. Signal lines should have 50 Ohm impedance while the package ground leads and exposed paddle should be connected directly to the ground plane similar to that shown. A sufficient number of via holes should be used to connect the top and bottom ground planes. The evaluation board should be mounted to an appropriate heat sink. The evaluation circuit board shown is available from Hittite upon request.

**GaAs MMIC SP4T REFLECTIVE
SWITCH 23 - 30 GHz****Notes:**