

GaAs MMIC SMT DOUBLE-BALANCED MIXER, 6 - 15 GHz

Typical Applications

The HMC141C8 is ideal for:

- Microwave Pt to Pt Radios
- VSAT Ground Equipment

Features

Input IP3: +21 dBm

Conversion Loss: 8.5 dB

LO to RF Isolation: 35 dB

Functional Diagram

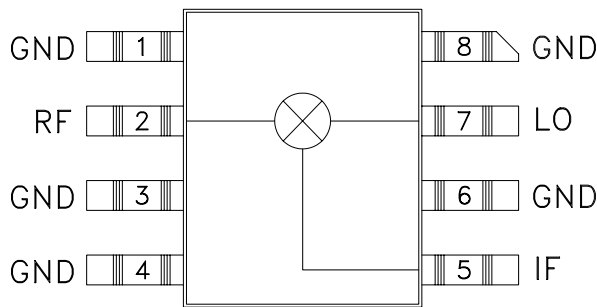

General Description

The HMC141C8 is a miniature passive double-balanced mixer in a non-hermetic ceramic surface mount package that can be used as an upconverter or downconverter. The device is a passive diode/balun type mixer with high dynamic range. The mixer can handle larger signal levels than most active mixers due to the high third order intercept of 20 dBm. MMIC implementation provides exceptional balance in the circuit resulting in high LO/RF and LO/IF isolations and unit-to-unit consistency. This mixer has applications where small size and surface mount compatibility are important.

Electrical Specifications, $T_A = +25^\circ\text{C}$, LO Drive = +15 dBm

Parameter	Min.	Typ.	Max.	Units
Frequency Range, RF & LO	6 - 15			GHz
Frequency Range, IF	DC - 2			GHz
Conversion Loss	7 - 11 GHz	8.5	10	dB
	6 - 18 GHz	10	12	dB
Noise Figure (SSB)		8.5	10	dB
LO to RF Isolation	28	35		dB
LO to IF Isolation	17	25		dB
IP3 (Input)		20		dBm
IP2 (Input)		45		dBm
1 dB Gain Compression (Input)		10		dBm

GaAs MMIC SMT DOUBLE-BALANCED MIXER, 6 - 15 GHz

Conversion Loss

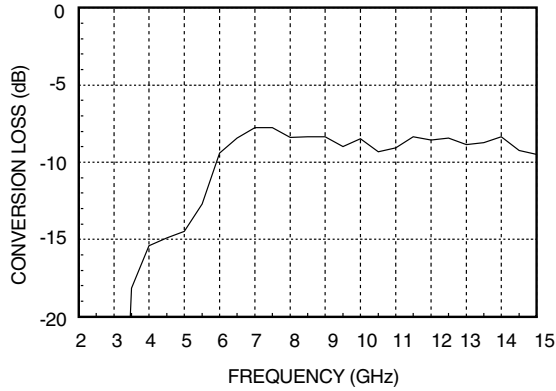

Isolation

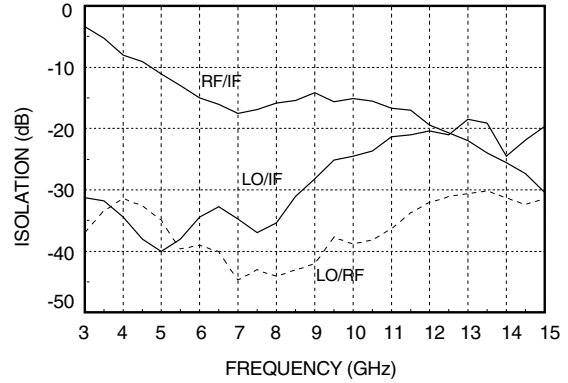

Conversion Loss vs LO Power

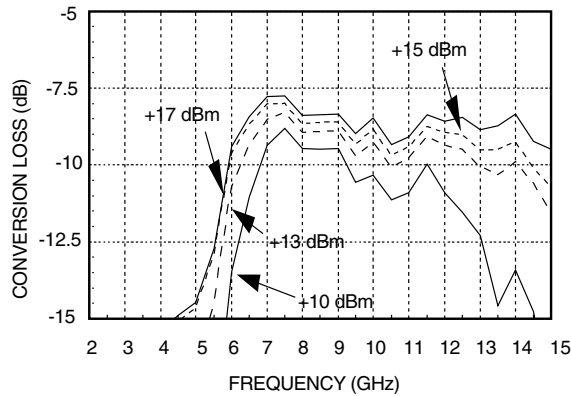

Isolation vs LO Drive Level

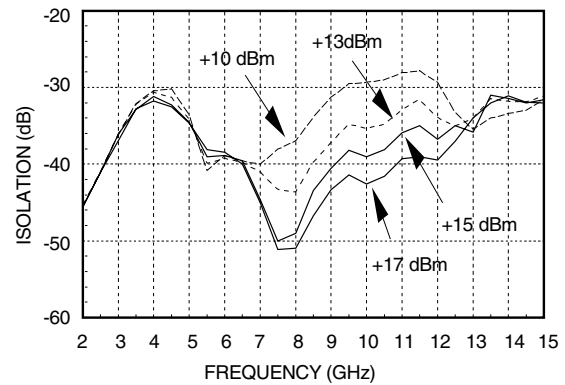

Return Loss

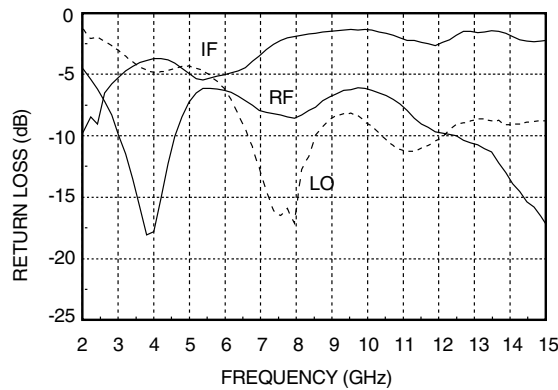

Distortion and 1dB Compression vs. LO Drive Level

Distortion			
LO Drive	Distortion		1 dB Compression
	RF (f1)= 11.01 GHz RF (f2)= 11.00 GHz LO= 11.5 GHz RF Level= 0 dBm		
(dBm)	IP3 (dBm)	IP2 (dBm)	P1dB (dBm)
+13	18	42	7
+15	21	45	10
+17	21	45	10

GaAs MMIC SMT DOUBLE-BALANCED MIXER, 6 - 15 GHz

Absolute Maximum Ratings

RF/IF Input	+13 dBm
LO Drive	+27 dBm
Storage Temperature	-65 to +150 °C
Operating Temperature	-55 to +85 °C

Outline Drawing

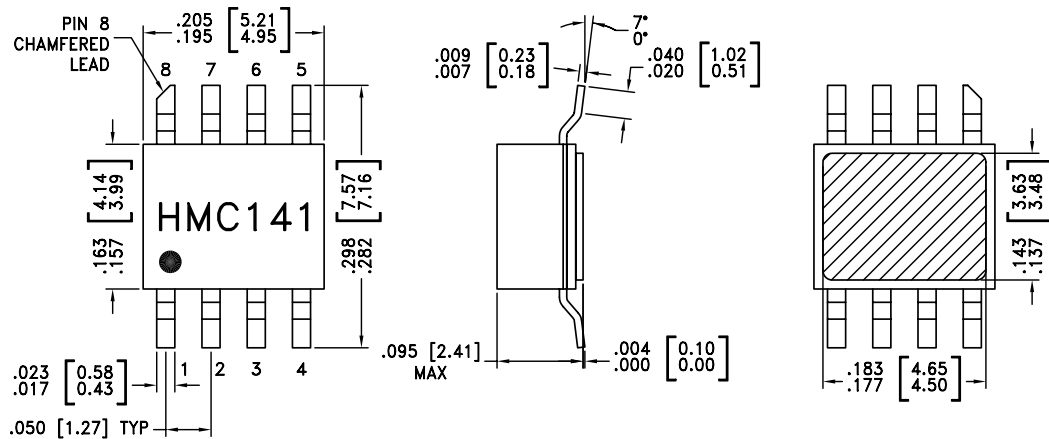

NOTES:

1. PACKAGE BODY MATERIAL: WHITE ALUMINA 92%
2. LEAD, PACKAGE BOTTOM MATERIAL: COPPER
3. PLATING: ELECTROLYTIC GOLD 100-200 MICROINCHES, OVER ELECTROLYTIC NICKEL 100-250 MICROINCHES.
4. DIMENSIONS ARE IN INCHES [MILLIMETERS].
5. PACKAGE LENGTH AND WIDTH DIMENSIONS DO NOT INCLUDE LID SEAL PROTRUSION .005 PER SIDE.
6. ALL GROUND LEADS AND GROUND PADDLE MUST BE SOLDERED TO PCB RF GROUND.

GaAs MMIC SMT DOUBLE-BALANCED MIXER, 6 - 15 GHz

Evaluation PCB

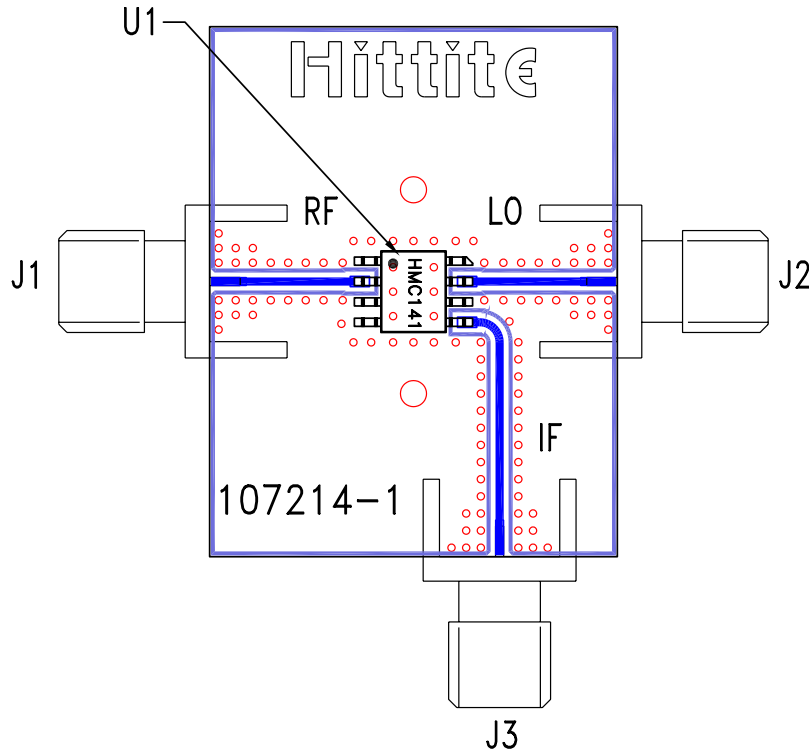

List of Material

Item	Description
J1 - J3	PC Mount SMA RF Connector
U1	HMC141C8 Mixer
PCB*	107214 Evaluation Board
* Circuit Board Material: Rogers 4350	

The circuit board used in the final application should use RF circuit design techniques. Signal lines should have 50 ohm impedance while the package ground leads and exposed paddle should be connected directly to the ground plane similar to that shown. A sufficient number of VIA holes should be used to connect the top and bottom ground planes. The evaluation circuit board shown is available from Hittite upon request.