

GaAs MMIC SMT LOW DISTORTION T/R SWITCH, DC - 2.5 GHz

Typical Applications

The HMC154S8 is ideal for:

- MMDS & WirelessLAN
- Basestation Infrastructure
- Portable Wireless

Features

- High Third Order Intercept: +60 dBm
- Single Positive Supply: +3 to +10V
- High RF Power Capability
- TTL/CMOS Control

Functional Diagram

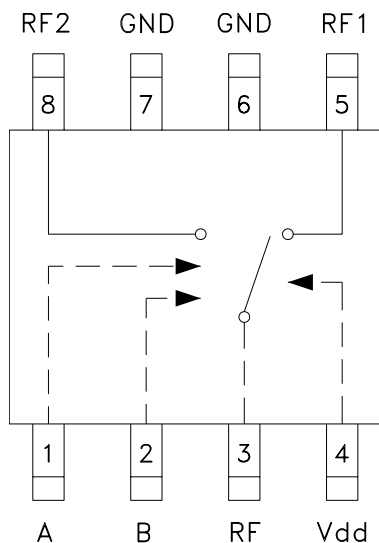

General Description

The HMC154S8 is a low-cost SPDT switch in an 8-lead SOIC package for use in transmit-receive applications which require very low distortion at high signal power levels. The device can control signals from DC to 2.5 GHz and is especially suited for 900 MHz and 1.8 - 2.2 GHz applications. The design provides exceptional intermodulation performance; providing a +60dBm third order intercept at 8 Volt bias. RF1 and RF2 are reflective shorts when "Off". On-chip circuitry allows single positive supply operation at very low DC current with control inputs compatible with CMOS and most TTL logic families.

Electrical Specifications, $T_A = +25^\circ C$, $V_{dd} = +5 V_{dc}$, 50 Ohm System

Parameter	Frequency	Min.	Typ.	Max.	Units
Insertion Loss	DC - 1.0 GHz		0.5	0.7	dB
	DC - 2.0 GHz		0.7	0.9	dB
	DC - 2.5 GHz		1.0	1.3	dB
Isolation	DC - 1.0 GHz	22	25		dB
	DC - 2.0 GHz	19	22		dB
	DC - 2.5 GHz	15	18		dB
Return Loss	DC - 1.0 GHz	20	30		dB
	DC - 2.0 GHz	14	18		dB
	DC - 2.5 GHz	10	13		dB
Input Power for 1 dB Compression	0/8V Control	0.5 - 1.0 GHz	35	39	dBm
		0.5 - 2.0 GHz	34	38	dBm
Input Third Order Intercept	0/8V Control	0.5 - 1.0 GHz	55	60	dBm
		0.5 - 2.0 GHz	54	60	dBm
Switching Characteristics	DC - 2.5 GHz	tRISE, tFALL (10/90% RF)		10	ns
		tON, tOFF (50% CTL to 10/90% RF)		24	ns

GaAs MMIC SMT LOW DISTORTION T/R SWITCH, DC - 2.5 GHz

Insertion Loss

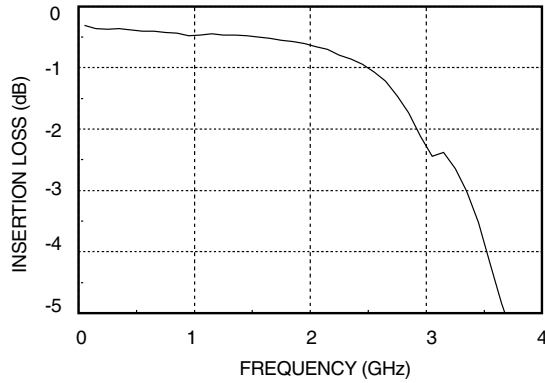

Isolation

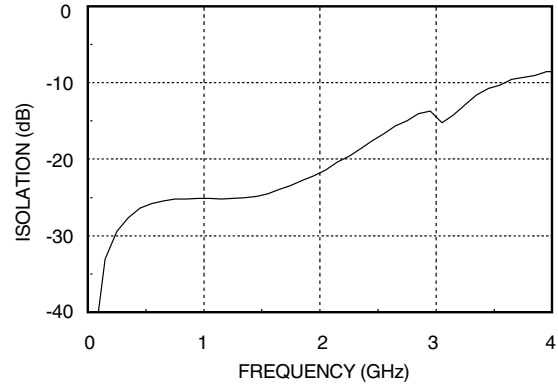

Return Loss

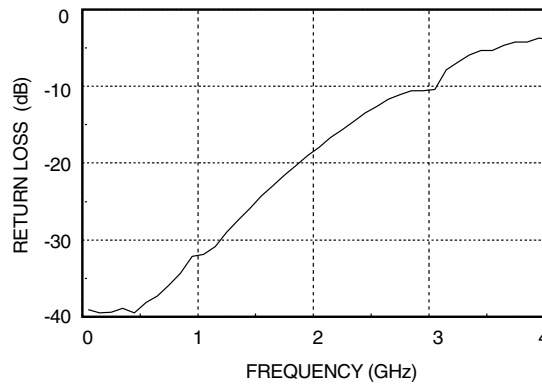

Input Power for 0.1 and 1.0 dB Compression vs. Bias Voltage

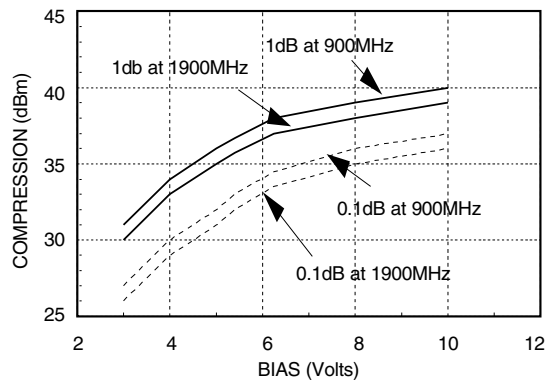

Input Third Order Intercept vs. Bias Voltage

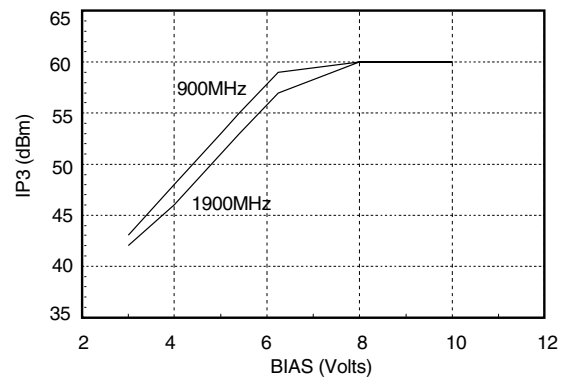

GaAs MMIC SMT LOW DISTORTION T/R SWITCH, DC - 2.5 GHz

Compression vs. Bias Voltage

Bias Vdd	Carrier at 900 MHz		Carrier at 1900 MHz	
	Input Power for 0.1 dB Compression	Input Power for 1.0 dB Compression	Input Power for 0.1 dB Compression	Input Power for 1.0 dB Compression
	(Volts)	(dBm)	(dBm)	(dBm)
3	27	31	26	30
4	30	34	29	33
5	32	36	31	35
8	36	39	35	38
10	37	40	36	39

Caution: Do not operate in 1dB compression at power levels above +35dBm and do not "hot switch" power levels greater than +23dBm (Vdd = +5V).

Distortion vs. Bias Voltage

Bias Vdd	1 Watt Carrier at 900 MHz			1 Watt Carrier at 1900 MHz		
	Third Order Intercept	Second Order Intercept	Second Harmonic	Third Order Intercept	Second Order Intercept	Second Harmonic
	(Volts)	(dBm)	(dBm)	(dBc)	(dBm)	(dBm)
3	43	71	45	42	78	55
4	48	85	55	46	88	65
5	53	90	56	51	87	58
8	60	90	58	60	90	59
10	60	90	59	60	90	60

Truth Table

*Control Input Voltage Tolerances are ± 0.2 Vdc.

Bias Vdd (Vdc)	Control Input*		Bias Current Idd (uA)	Control Current Ia (uA)	Control Current Ib (uA)	Signal Path State	
	A (Vdc)	B (Vdc)				RF to RF1	RF to RF2
3	0	0	30	-15	-15	OFF	OFF
3	0	Vdd	25	-25	0	ON	OFF
3	Vdd	0	25	0	-25	OFF	ON
5	0	0	110	-55	-55	OFF	OFF
5	0	Vdd	115	-100	-15	ON	OFF
5	Vdd	0	115	-15	-100	OFF	ON
10	0	0	380	-190	-190	OFF	OFF
10	0	Vdd	495	-275	-220	ON	OFF
10	Vdd	0	495	-220	-275	OFF	ON
5	-Vdd	Vdd	600	-600	225	ON	OFF
5	Vdd	-Vdd	600	225	-600	OFF	ON

GaAs MMIC SMT LOW DISTORTION T/R SWITCH, DC - 2.5 GHz



Absolute Maximum Ratings

Bias Voltage Range (Vdd)	-0.2 to +12 Vdc
Control Voltage Range (A & B)	-0.2 to Vdd Vdc
Storage Temperature	-65 to +150 °C
Operating Temperature	-40 to +85 °C

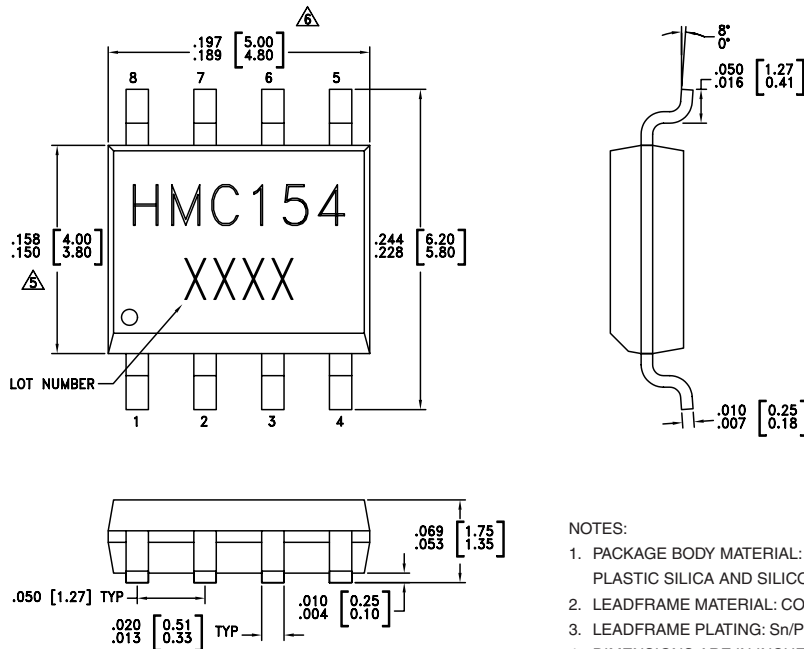
Outline Drawing



NOTES:

1. PACKAGE BODY MATERIAL: LOW STRESS INJECTION MOLDED PLASTIC SILICA AND SILICON IMPREGNATED.
2. LEADFRAME MATERIAL: COPPER ALLOY
3. LEADFRAME PLATING: Sn/Pb SOLDER
4. DIMENSIONS ARE IN INCHES [MILLIMETERS].
5.  DIMENSION DOES NOT INCLUDE MOLDFLASH OF 0.15mm PER SIDE.
6.  DIMENSION DOES NOT INCLUDE MOLDFLASH OF 0.25mm PER SIDE.
7. ALL GROUND LEADS MUST BE SOLDERED TO PCB RF GROUND.

GaAs MMIC SMT LOW DISTORTION T/R SWITCH, DC - 2.5 GHz

Typical Application Circuit

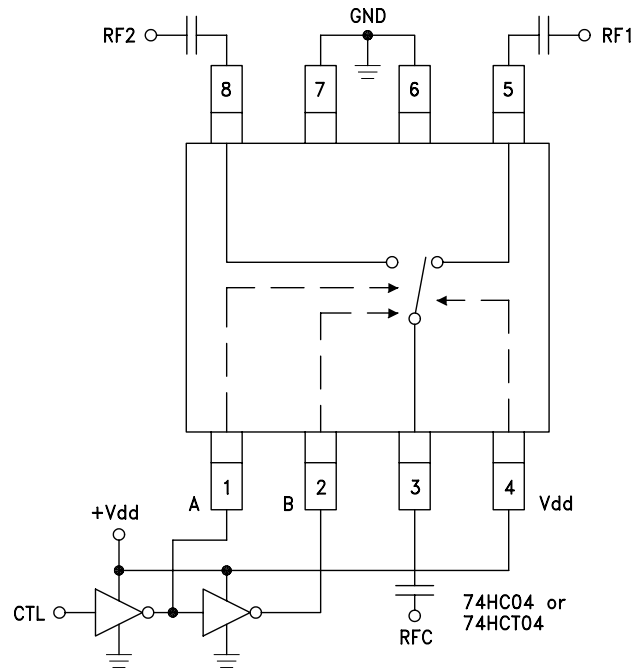

Notes:

1. Set logic gate and switch Vdd = +3V to +5V and use HCT series logic to provide a TTL driver interface.
2. Control inputs A/B can be driven directly with CMOS logic (HC) with Vdd of 3 to 8 Volts applied to the CMOS logic gates and to pin 4 of the RF switch.
3. DC Blocking capacitors are required for each RF port as shown. Capacitor value determines lowest frequency of operation.
4. Highest RF signal power capability is achieved with V set to +10V. The switch will operate properly (but at lower RF power capability) at bias voltages down to +3V.

GaAs MMIC SMT LOW DISTORTION T/R SWITCH, DC - 2.5 GHz

Evaluation Circuit Board

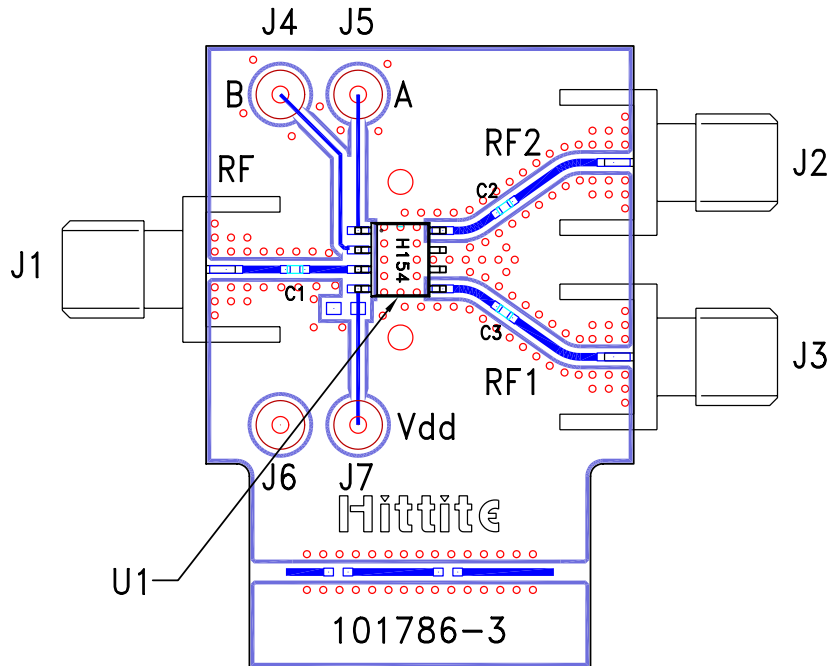

List of Material

Item	Description
J1 - J3	PC Mount SMA RF Connector
J4 - J7	DC Pin
C1 - C3	330 pF Capacitor, 0402 Pkg.
U1	HMC154S8 SPDT Switch
PCB*	101786 Evaluation PCB
* Circuit Board Material: Rogers 4350	

The circuit board used in the final application should be generated with proper RF circuit design techniques. Signal lines at the RF port should have 50 ohm impedance and the package ground leads and package bottom should be connected directly to the ground plane similar to that shown above. The evaluation circuit board shown above is available from Hittite Microwave Corporation upon request.