

GaAs MMIC SOT26 T/R SWITCH, DC - 2.5 GHz

Typical Applications

The HMC195 is ideal for:

- MMDS & WirelessLAN
- PCMCIA Wireless Cards
- Portable Wireless

Functional Diagram

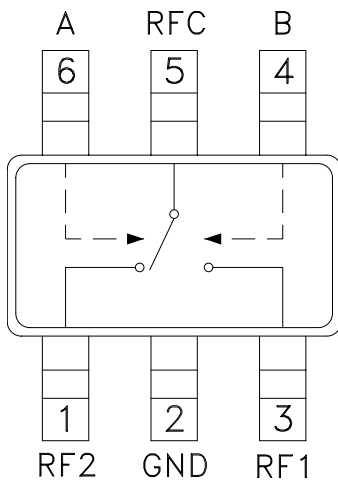

Features

- Low Insertion Loss: 0.4 dB
- Ultra Small Package: SOT26
- High Input IP3: +62 dBm
- Positive Control: 0/+3V to 0/+8V

General Description

The HMC195 is a low-cost SPDT switch in a 6-lead SOT26 package for use in transmit or receive applications which require very low distortion at high signal power levels. The device can control signals from DC to 2.5 GHz and is especially suited for 900 MHz and 1.8 - 2.2 GHz applications with less than 1 dB loss. The design provides exceptional intermodulation performance; a +62 dBm third order intercept at 8 Volt bias. RF1 and RF2 are reflective shorts when "Off". On-chip circuitry allows single positive supply operation at very low DC current with control inputs compatible with CMOS and most TTL logic families.

Electrical Specifications, $T_A = +25^\circ C$, $V_{ctl} = 0/+5 V_{dc}$, 50 Ohm System

Parameter	Frequency	Min.	Typ.	Max.	Units
Insertion Loss	DC - 1.0 GHz		0.4	0.7	dB
	DC - 2.0 GHz		0.6	0.9	dB
	DC - 2.5 GHz		1.1	1.4	dB
Isolation	DC - 1.0 GHz	22	25		dB
	DC - 2.0 GHz	19	23		dB
	DC - 2.5 GHz	15	18		dB
Return Loss	DC - 1.0 GHz	20	26		dB
	DC - 2.0 GHz	12	15		dB
	DC - 2.5 GHz	9	11		dB
Input Power for 1dB Compression	0.5 - 1.0 GHz 0.5 - 2.5 GHz	0/+8V Control	30	36	dBm
			29	35	dBm
Input Third Order Intercept	0.5 - 1.0 GHz 0.5 - 2.5 GHz	0/+8V Control	58	62	dBm
			55	59	dBm
Switching Characteristics	DC - 2.5 GHz				
		tRISE, tFALL (10/90% RF)		10	ns
		tON, tOFF (50% CTL to 10/90% RF)		24	ns

**GaAs MMIC SOT26 T/R
SWITCH, DC - 2.5 GHz**

Insertion Loss

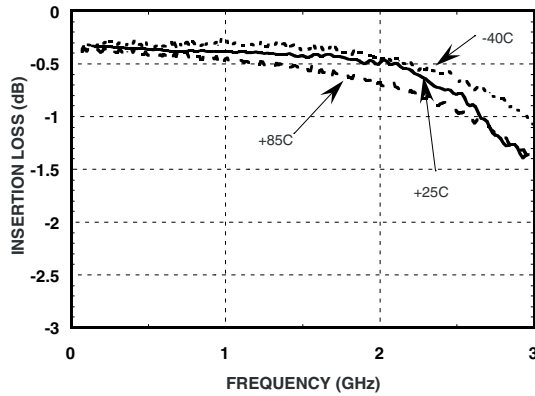

Isolation

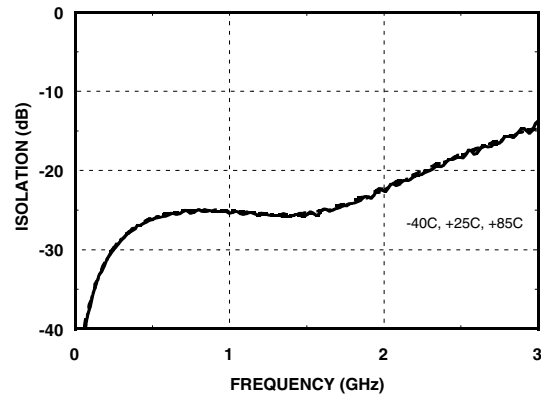

Return Loss

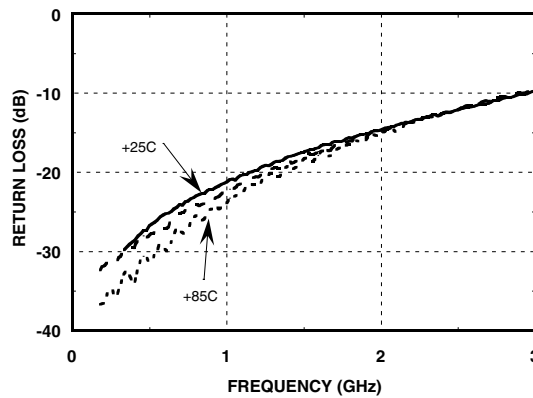

**Input 0.1 and 1.0 dB
Compression vs. Control Voltage**

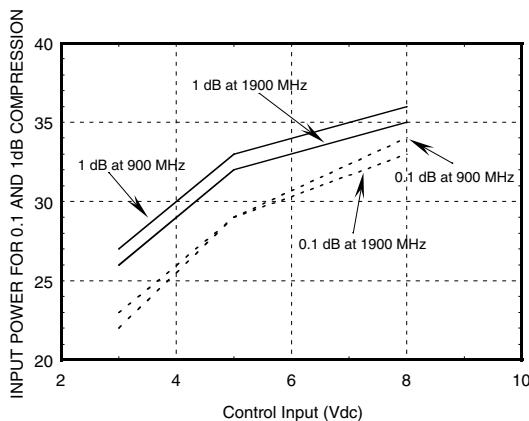

**Input Third Order
Intercept Point vs. Control Voltage**

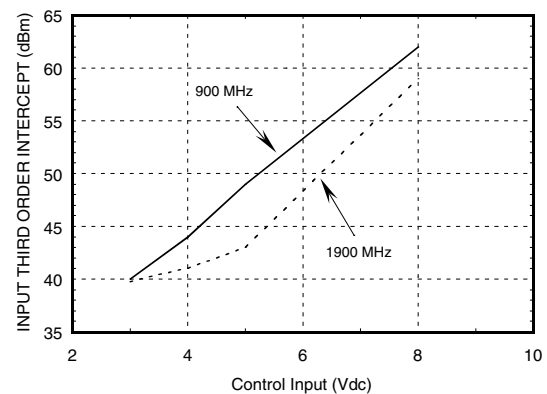

GaAs MMIC SOT26 T/R SWITCH, DC - 2.5 GHz

Compression vs. Bias Voltage

Control Input	Carrier at 900 MHz		Carrier at 1900 MHz	
	Input Power for 0.1 dB Compression	Input Power for 1.0 dB Compression	Input Power for 0.1 dB Compression	Input Power for 1.0 dB Compression
(Vdc)	(dBm)	(dBm)	(dBm)	(dBm)
+3	23	27	22	26
+5	29	33	29	32
+8	34	36	33	35

Caution: Do not operate in 1dB compression at power levels above +33 dBm and do not "hot switch" power levels greater than +23dBm (Vctl = +5Vdc).

DC blocks are required at ports RFC, RF1 and RF2.

Distortion vs. Bias Voltage

Control Input	1 Watt Carrier at 900 MHz		1 Watt Carrier at 1900 MHz	
	Third Order Intercept	Second Order Intercept	Third Order Intercept	Second Order Intercept
(Vdc)	(dBm)	(dBm)	(dBm)	(dBm)
+3	40	87	39	79
+4	44	88	41	85
+5	49	90	43	91
+8	62	90	59	99

Truth Table

*Control Input Voltage Tolerances are ± 0.2 Vdc.

Control Input*		Control Current		Signal Path State	
A (Vdc)	B (Vdc)	Ia (μ A)	Ib (μ A)	RF to RF1	RF to RF2
0	+3	-25	25	ON	OFF
+3	0	25	-25	OFF	ON
0	+5	-120	120	ON	OFF
+5	0	120	-120	OFF	ON
0	+8	-200	200	ON	OFF
+8	0	200	-200	OFF	ON

Absolute Maximum Ratings

Max. Input Power $V_{CTL} = 0/+8V$	0.05 GHz 0.5 - 2.5 GHz	+27 dBm +34 dBm
Control Voltage Range (A & B)		-0.2 to +12 Vdc
Storage Temperature		-65 to +150 °C
Operating Temperature		-40 to +85 °C

Outline Drawing

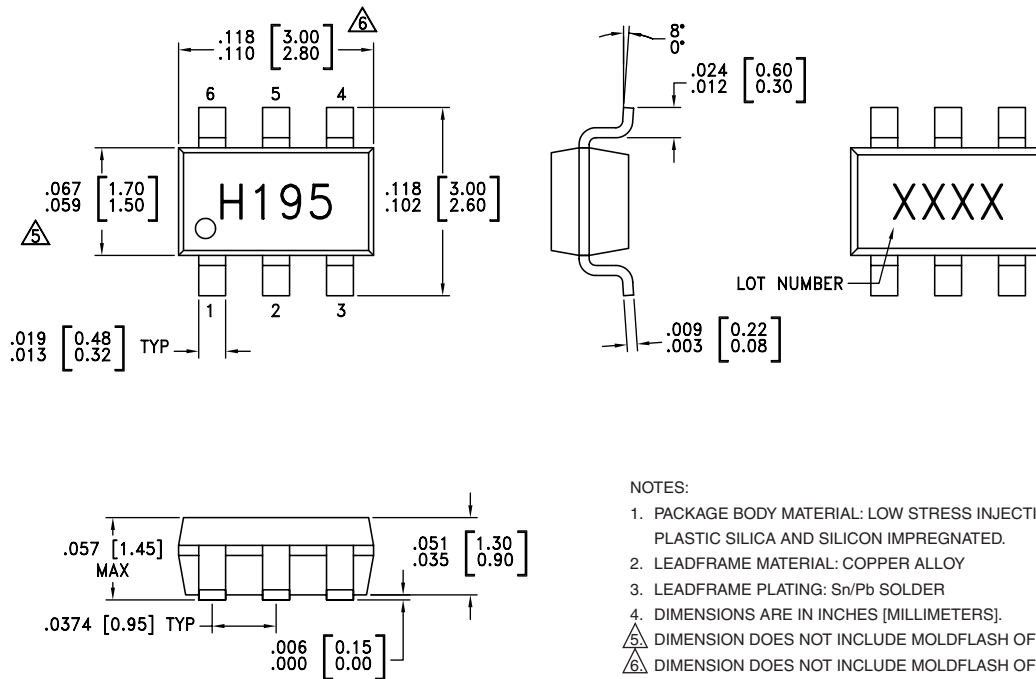

NOTES:

1. PACKAGE BODY MATERIAL: LOW STRESS INJECTION MOLDED PLASTIC SILICA AND SILICON IMPREGNATED.
2. LEADFRAME MATERIAL: COPPER ALLOY
3. LEADFRAME PLATING: Sn/Pb SOLDER
4. DIMENSIONS ARE IN INCHES [MILLIMETERS].
5. DIMENSION DOES NOT INCLUDE MOLDFLASH OF 0.15mm PER SIDE.
6. DIMENSION DOES NOT INCLUDE MOLDFLASH OF 0.25mm PER SIDE.
7. ALL GROUND LEADS MUST BE SOLDERED TO PCB RF GROUND.

Typical Application Circuit

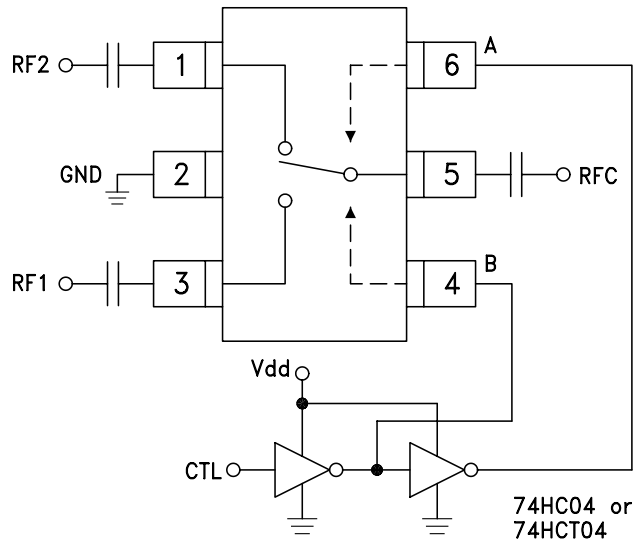

Notes:

1. Set logic gate and switch Vdd = +3V to +5V and use HCT series logic to provide a TTL driver interface.
2. Control inputs A/B can be driven directly with CMOS logic (HC) with Vdd of 3 to 8 Volts applied to the CMOS logic gates.
3. DC Blocking capacitors are required for each RF port as shown. Capacitor value determines lowest frequency of operation.
4. Highest RF signal power capability is achieved with V set to +10V. The switch will operate properly (but at lower RF power capability) at bias voltages down to +3V.

Evaluation Circuit Board

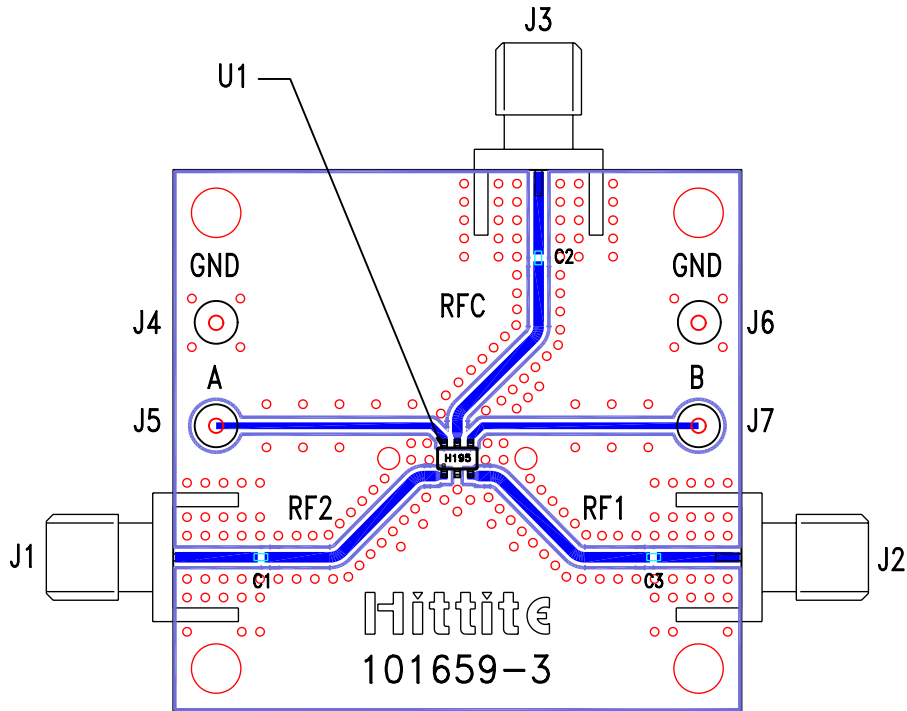

List of Material

Item	Description
J1 - J3	PC Mount SMA RF Connector
J4 - J7	DC Pin
C1 - C3	330 pF capacitor, 0402 Pkg.
U1	HMC195 T/R Switch
PCB*	101659 Evaluation PCB
* Circuit Board Material: Rogers 4350	

The circuit board used in the final application should be generated with proper RF circuit design techniques. Signal lines at the RF port should have 50 ohm impedance and the package ground leads and package bottom should be connected directly to the ground plane similar to that shown above. The evaluation circuit board shown above is available from Hittite Microwave Corporation upon request.