

Typical Applications

The HMC224MS8 / HMC224MS8E is ideal for:

- UNII & HiperLAN
- PCMCIA WirelessLAN

Features

- Low Cost 5-6 GHz Switch
- Ultra Small Package: MSOP8
- High Input P1dB: +33 dBm
- Single Positive Supply: +3 to +8V

Functional Diagram

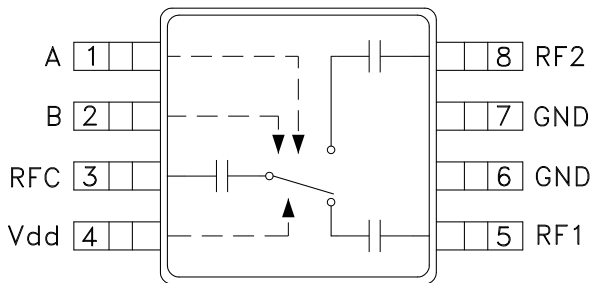

General Description

The HMC224MS8 & HMC224MS8E are low-cost SPDT switches in 8-lead MSOP packages for use in transmit-receive applications. The device can control signals from 5.0 to 6.0 GHz and is especially suited for 5.2 GHz UNII and 5.8 GHz ISM applications with only 1.2 dB loss. The design provides exceptional power handling performance; input P1dB = +33 dBm at 5 Volt bias. RF1 and RF2 are reflective shorts when "Off". On-chip circuitry allows single positive supply operation at very low DC current with control inputs compatible with CMOS and most TTL logic families. No DC blocking capacitors are required on RF I/O ports.

Electrical Specifications, $T_A = +25^\circ C$, $V_{dd} = +5 V_{dc}$, 50 Ohm System

Parameter	Frequency	Min.	Typ.	Max.	Units
Insertion Loss	5.0 - 6.0 GHz		1.3	1.6	dB
	5.1 - 5.4 GHz		1.2	1.5	dB
	5.4 - 5.9 GHz		1.3	1.6	dB
Isolation	5.0 - 6.0 GHz	20	24		dB
	5.1 - 5.4 GHz	26	31		dB
	5.4 - 5.9 GHz	22	27		dB
Return Loss	RF Common	5.0 - 6.0 GHz	11	15	dB
		5.1 - 5.9 GHz	12	16	dB
	RF1 & RF2	5.0 - 6.0 GHz	11	14	dB
		5.1 - 5.9 GHz	11	15	dB
Input Power for 1 dB Compression	0/3V Control	5.0 - 6.0 GHz	27	31	dBm
	0/5V Control	5.0 - 6.0 GHz	29	33	dBm
Input Third Order Intercept	0/3V Control	5.0 - 6.0 GHz	31	35	dBm
	0/5V Control	5.0 - 6.0 GHz	33	37	dBm
Switching Characteristics		5.0 - 6.0 GHz			
	tRISE, tFALL (10/90% RF)		10		ns
	tON, tOFF (50% CTL to 10/90% RF)		25		ns

For price, delivery, and to place orders, please contact Hittite Microwave Corporation:
20 Alpha Road, Chelmsford, MA 01824 Phone: 978-250-3343 Fax: 978-250-3373
Order On-line at www.hittite.com



Insertion Loss

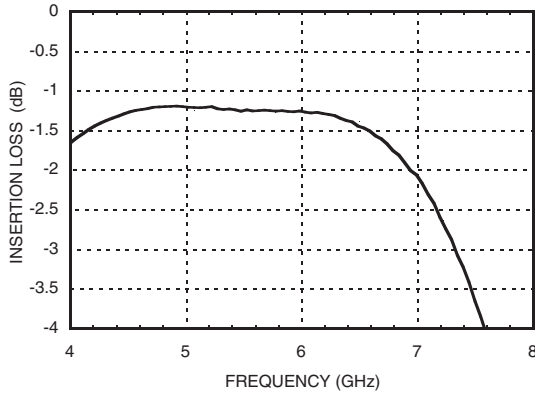

Isolation

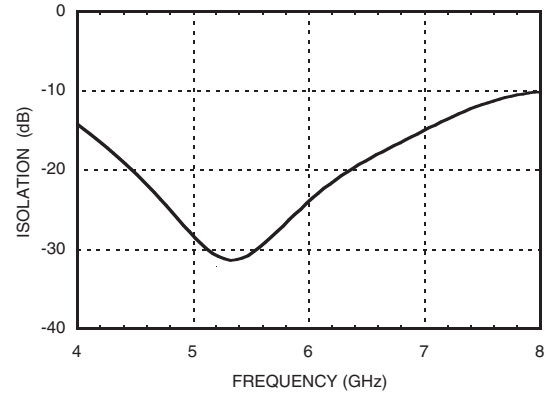

Return Loss

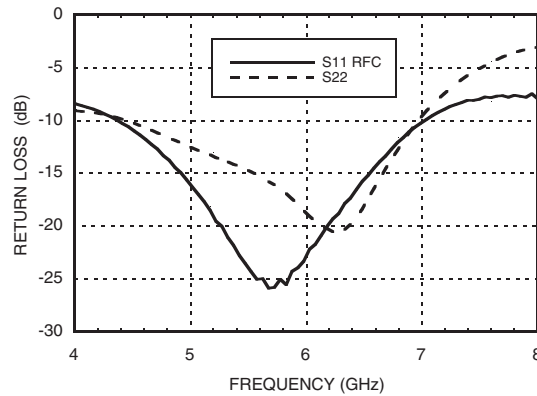

Truth Table

*Control Input Voltage Tolerances are ± 0.2 Vdc.

Bias Vdd (Vdc)	Control Input*		Bias Current Idd (uA)	Control Current			Signal Path State	
	A (Vdc)	B (Vdc)		Ia (uA)	Ib (uA)	Ic (uA)	RF to RF1	RF to RF2
3	0	0	10	-5	-5		OFF	OFF
3	0	Vdd	10	-10	0		ON	OFF
3	Vdd	0	10	0	-10		OFF	ON
5	0	0	45	-22	-23		OFF	OFF
5	0	Vdd	45	-5	-40		ON	OFF
5	Vdd	0	115	-40	-5		OFF	ON

Caution:

Do not operate in 1dB compression at power levels above +33 dBm and do not "hot switch" power levels greater than +23 dBm (Vdd = +5Vdc). DC blocks are not required at ports RFC, RF1 and RF2.



Absolute Maximum Ratings

Bias Voltage Range (Vdd)	-0.2 to +12 Vdc
Control Voltage Range (A & B)	-0.2 to Vdd Vdc
Storage Temperature	-65 to +150 °C
Operating Temperature	-40 to +85 °C



**ELECTROSTATIC SENSITIVE DEVICE
OBSERVE HANDLING PRECAUTIONS**

10

SWITCHES - SMT

Outline Drawing

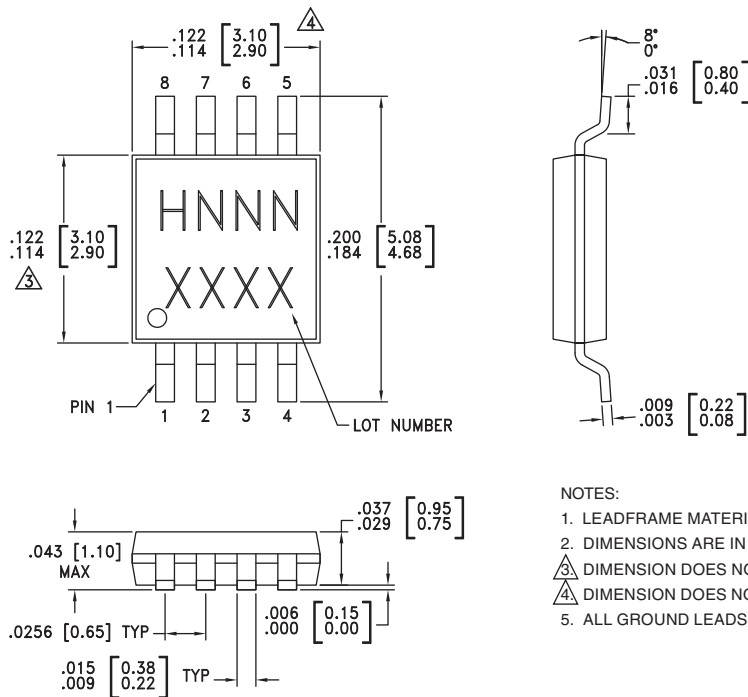

NOTES:

1. LEADFRAME MATERIAL: COPPER ALLOY
2. DIMENSIONS ARE IN INCHES [MILLIMETERS]
- ⚠ DIMENSION DOES NOT INCLUDE MOLDFLASH OF 0.15mm PER SIDE.
- ⚠ DIMENSION DOES NOT INCLUDE MOLDFLASH OF 0.25mm PER SIDE.
5. ALL GROUND LEADS MUST BE SOLDERED TO PCB RF GROUND.

Package Information

Part Number	Package Body Material	Lead Finish	MSL Rating	Package Marking ^[3]
HMC224MS8	Low Stress Injection Molded Plastic	Sn/Pb Solder	MSL1 ^[1]	H224 XXXX
HMC224MS8E	RoHS-compliant Low Stress Injection Molded Plastic	100% matte Sn	MSL1 ^[2]	H224 XXXX

[1] Max peak reflow temperature of 235 °C

[2] Max peak reflow temperature of 260 °C

[3] 4-Digit lot number XXXX

For price, delivery, and to place orders, please contact Hittite Microwave Corporation:
20 Alpha Road, Chelmsford, MA 01824 Phone: 978-250-3343 Fax: 978-250-3373
Order On-line at www.hittite.com

Typical Application Circuit

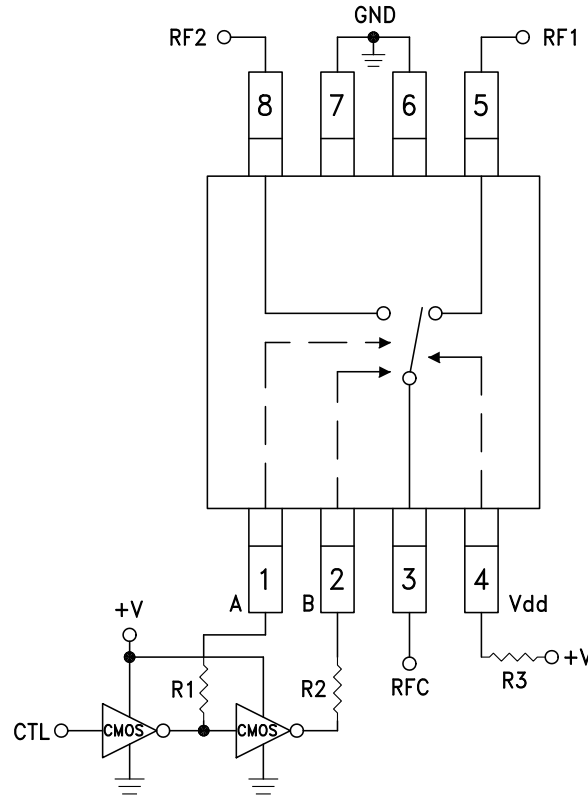

Notes:

1. Control Inputs A and B can be driven directly with CMOS logic (HC) with V of 3 to 8 Volts applied to the CMOS logic gates and to pin 4 of the RF switch.
2. Set V to 5 Volts and use HCT series logic to provide a TTL driver interface.
3. Highest RF signal power capability is achieved with V set to +10V. However, the switch will operate properly (but at lower RF power capability) at bias voltages down to +3V.
4. RF ByPass: Do not use RF bypass capacitors on Vdd, A or B ports. Resistors R1, R2, R3 = 100 Ohms should be placed close to the Vdd, A and B ports. Use resistor size 0402 to minimize parasitic inductances and capacitances.
5. DC Blocking capacitors are not required for each RF port.
6. Evaluation PCB available.

Evaluation PCB

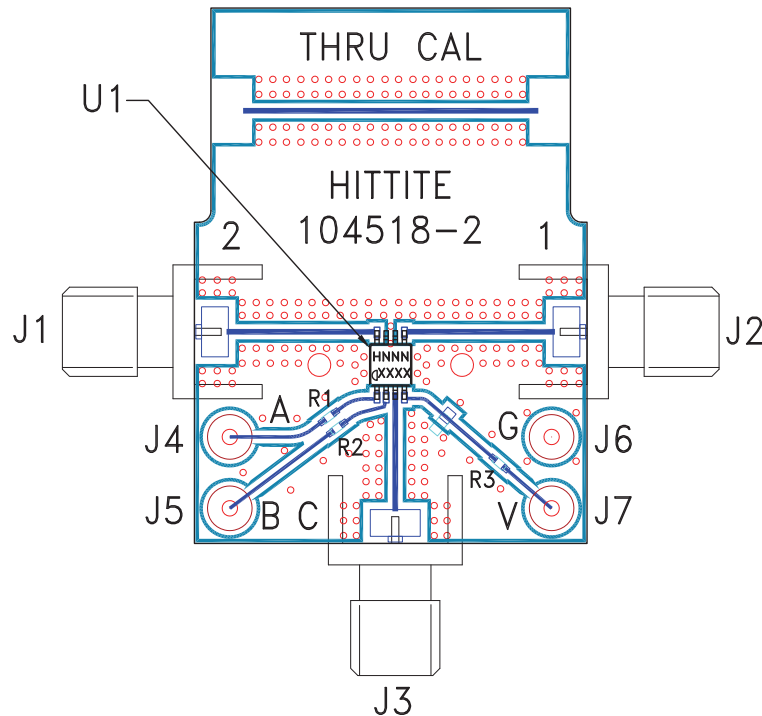

List of Materials for Evaluation PCB 104771 [1]

Item	Description
J1 - J3	PCB Mount SMA RF Connector
J4 - J7	DC Pin
R1, R3	100 Ω resistor, 0402 Pkg.
U1	HMC224MS8 / HMC224MS8E T/R Switch
PCB [2]	104518 Evaluation PCB

[1] Reference this number when ordering complete evaluation PCB

[2] Circuit Board Material: Rogers 4350

The circuit board used in the final application should be generated with proper RF circuit design techniques. Signal lines at the RF port should have 50 ohm impedance and the package ground leads should be connected directly to the ground plane similar to that shown above. The evaluation circuit board shown above is available from Hittite Microwave Corporation upon request.



Notes: