

FEATURES

Downconverter

Conversion loss

7.5 dB typical for 10 GHz to 18 GHz

8.5 dB typical for 18 GHz to 26 GHz

LO to RF isolation: 40 dB typical

LO to IF isolation

34 dB typical for 10 GHz to 18 GHz

37 dB typical for 18 GHz to 26 GHz

RF to IF isolation

20 dB typical for 10 GHz to 18 GHz

31 dB typical for 18 GHz to 26 GHz

IP3

18 dBm typical for 10 GHz to 18 GHz

22 dBm typical for 18 GHz to 26 GHz

P1dB

9.5 dBm typical for 10 GHz to 18 GHz

12 dBm typical for 18 GHz to 26 GHz

IF bandwidth: dc to 8 GHz

Passive: no dc bias required

Small size: 0.94 mm × 0.59 mm × 0.102 mm

APPLICATIONS

Point to point radios

Point to multipoint radios and very small aperture terminals
(VSATs)

Test equipment and sensors

Military end use

GENERAL DESCRIPTION

The HMC260A is a general-purpose, double balanced mixer that can be used as an upconverter or downconverter from 10 GHz to 26 GHz. This miniature monolithic mixer (MMIC) requires no external components or matching circuitry.

FUNCTIONAL BLOCK DIAGRAM

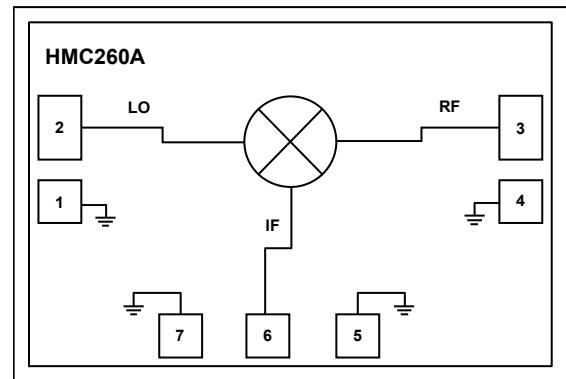

Figure 1.

16565-001

The HMC260A provides excellent local oscillator (LO) to radio frequency (RF) and LO to intermediate frequency (IF) suppression due to optimized balun structures. The mixer operates well with LO drive levels of 13 dBm or above. The HMC260A is also available in an SMT format as the [HMC260ALC3B](#).

Rev. 0

[Document Feedback](#)

Information furnished by Analog Devices is believed to be accurate and reliable. However, no responsibility is assumed by Analog Devices for its use, nor for any infringements of patents or other rights of third parties that may result from its use. Specifications subject to change without notice. No license is granted by implication or otherwise under any patent or patent rights of Analog Devices. Trademarks and registered trademarks are the property of their respective owners.

TABLE OF CONTENTS

Features	1	Isolation and Return Loss	9
Applications.....	1	IF Bandwidth	11
Functional Block Diagram	1	Spurious Performance	12
General Description	1	Theory of Operation	13
Revision History	2	Applications Information	14
Specifications.....	3	Typical Application Circuit.....	14
Electrical Specifications.....	3	Assembly Diagram	14
Absolute Maximum Ratings.....	4	Mounting and Bonding Techniques for Millimeter Wave GaAs MMICs.....	15
Thermal Resistance	4	Handling Precautions	15
ESD Caution.....	4	Mounting.....	15
Pin Configuration and Function Descriptions.....	5	Wire Bonding.....	15
Interface Schematics.....	5	Outline Dimensions	16
Typical Performance Characteristics	6	Ordering Guide	16
Downconverter, Upper Sideband, IF = 1000 MHz	6		
Upconverter, Upper Sideband, IF = 1000 MHz.....	8		

REVISION HISTORY

4/2018—Revision 0: Initial Version

SPECIFICATIONS

ELECTRICAL SPECIFICATIONS

$T_A = 25^\circ\text{C}$, IF = 1000 MHz, LO drive = 13 dBm, RF frequency range = 10 GHz to 18 GHz, all measurements performed as a downconverter with the upper sideband selected, unless otherwise noted.

Table 1.

Parameter	Symbol	Min	Typ	Max	Unit
FREQUENCY RANGE					
Radio Frequency	RF	10		18	GHz
Local Oscillator	LO	10		18	GHz
Intermediate Frequency	IF	DC		8	GHz
CONVERSION LOSS			7.5	11	dB
NOISE FIGURE			11		dB
ISOLATION					
LO to RF			40		dB
LO to IF		27	34		dB
RF to IF		13	20		dB
INPUT THIRD-ORDER INTERCEPT	IP3	13	18		dBm
INPUT SECOND-ORDER INTERCEPT	IP2		41		dBm
INPUT POWER					
1 dB Compression	P1dB		9.5		dBm
RETURN LOSS					
RF Port			21		dB
LO Port			20.5		dB

$T_A = 25^\circ\text{C}$, IF = 1000 MHz, LO drive = 13 dBm, RF frequency range = 18 GHz to 26 GHz, all measurements performed as a downconverter with the upper sideband selected, unless otherwise noted.

Table 2.

Parameter	Symbol	Min	Typ	Max	Unit
FREQUENCY RANGE					
Radio Frequency	RF	18		26	GHz
Local Oscillator	LO	18		26	GHz
Intermediate Frequency	IF	DC		8	GHz
CONVERSION LOSS			8.5	12	dB
NOISE FIGURE			11.5		dB
ISOLATION					
LO to RF			40		dB
LO to IF		32	37		dB
RF to IF		23	31		dB
INPUT THIRD-ORDER INTERCEPT	IP3	16	22		dBm
INPUT SECOND-ORDER INTERCEPT	IP2		48		dBm
INPUT POWER					
1 dB Compression	P1dB		12		dBm
RETURN LOSS					
RF Port			9.5		dB
LO Port			17		dB

ABSOLUTE MAXIMUM RATINGS

Table 3.

Parameter	Rating
RF Input Power	25 dBm
LO Input Power	27 dBm
IF Input Power	25 dBm
IF Source/Sink Current	3 mA
Channel Temperature	175°C
Continuous Power Dissipation, P_{DISS} ($T_A = 85^\circ\text{C}$; Derate 5 mW/ $^\circ\text{C}$ Above 85°C)	260 mW
Storage Temperature Range	-65°C to +150°C
Operating Temperature Range	-55°C to +85°C
Electrostatic Discharge (ESD) Sensitivity	
Human Body Model (HBM)	500 V
Field Induced Charged Device Model (FICDM)	1000 V

Stresses at or above those listed under Absolute Maximum Ratings may cause permanent damage to the product. This is a stress rating only; functional operation of the product at these or any other conditions above those indicated in the operational section of this specification is not implied. Operation beyond the maximum operating conditions for extended periods may affect product reliability.

THERMAL RESISTANCE

θ_{JC} is the junction to case thermal resistance.

Table 4. Thermal Resistance

Package Type	θ_{JC}	Unit
C-7-4	200	$^\circ\text{C}/\text{W}$

¹ See the JESD51-2 JEDEC standard for additional information on optimizing the thermal impedance (a printed circuit board with 3 × 3 vias).

ESD CAUTION



ESD (electrostatic discharge) sensitive device. Charged devices and circuit boards can discharge without detection. Although this product features patented or proprietary protection circuitry, damage may occur on devices subjected to high energy ESD. Therefore, proper ESD precautions should be taken to avoid performance degradation or loss of functionality.

PIN CONFIGURATION AND FUNCTION DESCRIPTIONS

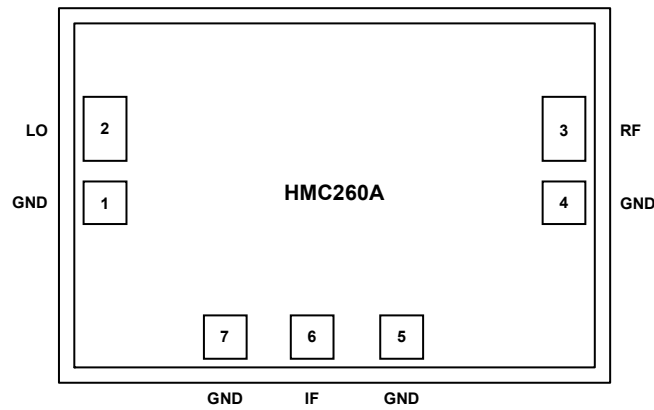

Figure 2. Pin Configuration

Table 5. Pin Function Descriptions

Pin No.	Mnemonic	Description
1, 4, 5, 7 (Die Bottom)	GND	Ground. Connect these pads to RF/dc ground. See Figure 3 for the GND interface schematic.
2	LO	Local Oscillator Port. This pad is ac-coupled and matched to 50 Ω. See Figure 4 for the LO interface schematic.
3	RF	Radio Frequency Port. This pad is ac-coupled and matched to 50 Ω. See Figure 5 for the RF interface schematic.
6	IF	Intermediate Frequency Port. This pad is dc-coupled. For applications not requiring operation to dc, dc block this port externally using a series capacitor with a value selected to pass the necessary IF frequency range. For operation to dc, this pin must not source or sink more than 3 mA of current. Otherwise, the device does not function and may fail. See Figure 6 for the IF interface schematic

INTERFACE SCHEMATICS



Figure 3. GND Interface Schematic

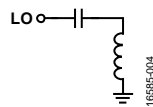

Figure 4. LO Interface Schematic

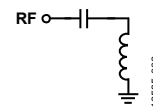

Figure 5. RF Interface Schematic

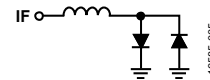

Figure 6. IF Interface Schematic

TYPICAL PERFORMANCE CHARACTERISTICS
DOWNCONVERTER, UPPER SIDEBAND, IF = 1000 MHz

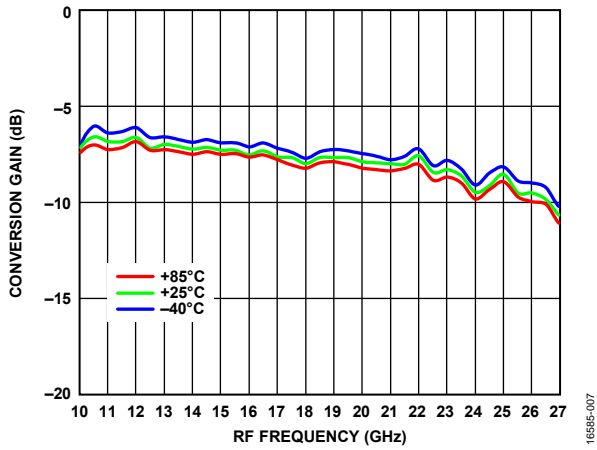

Figure 7. Conversion Gain vs. RF Frequency at Various Temperatures, LO Drive = 13 dBm

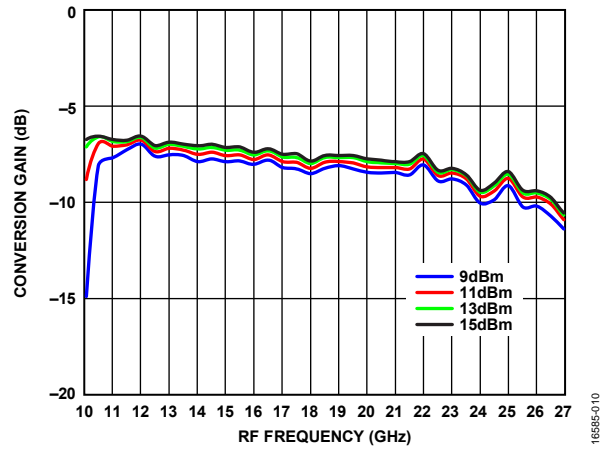

Figure 10. Conversion Gain vs. RF Frequency at Various LO Powers

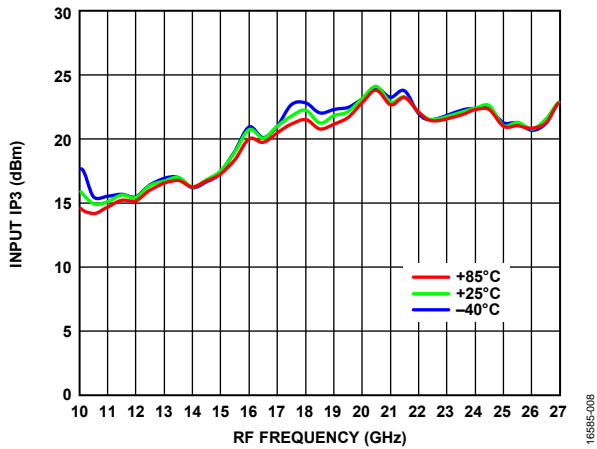

Figure 8. Input IP3 vs. RF Frequency at Various Temperatures, LO Drive = 13 dBm

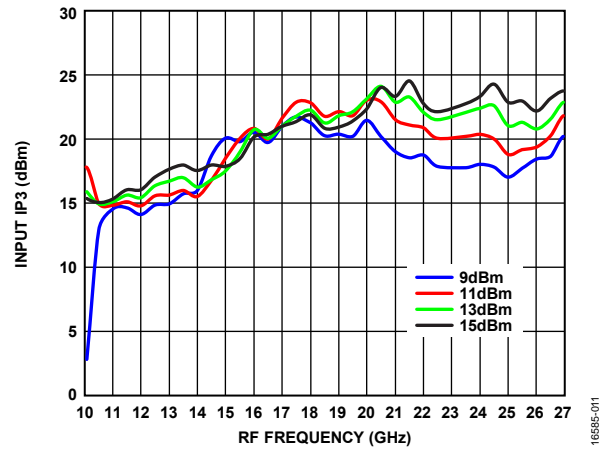

Figure 11. Input IP3 vs. RF Frequency at Various LO Powers

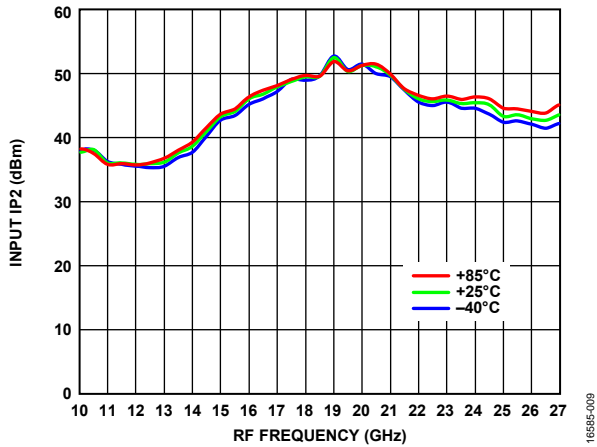

Figure 9. Input IP2 vs. RF Frequency at Various Temperatures, LO Drive = 13 dBm

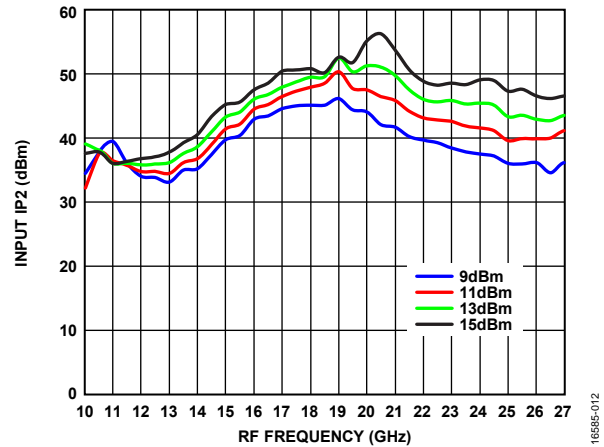

Figure 12. Input IP2 vs. RF Frequency at Various LO Powers

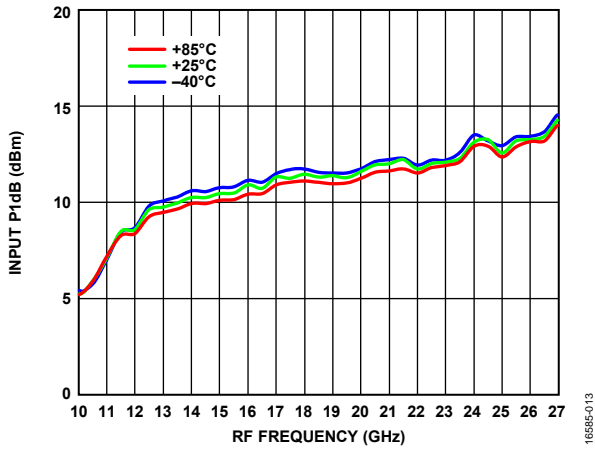

Figure 13. Input P1dB vs. RF Frequency at Various Temperatures, LO Drive = 13 dBm

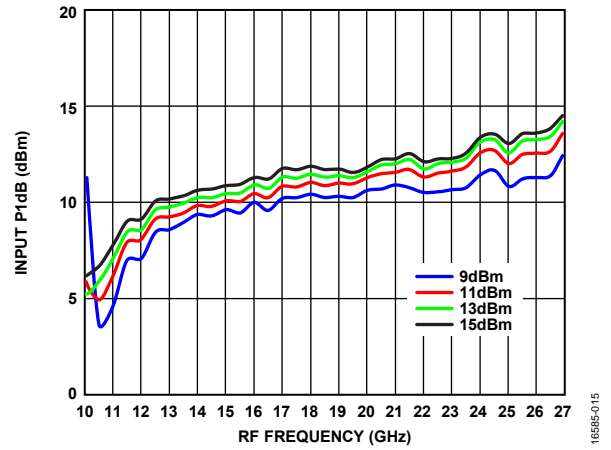

Figure 15. Input P1dB vs. RF Frequency at Various LO Powers

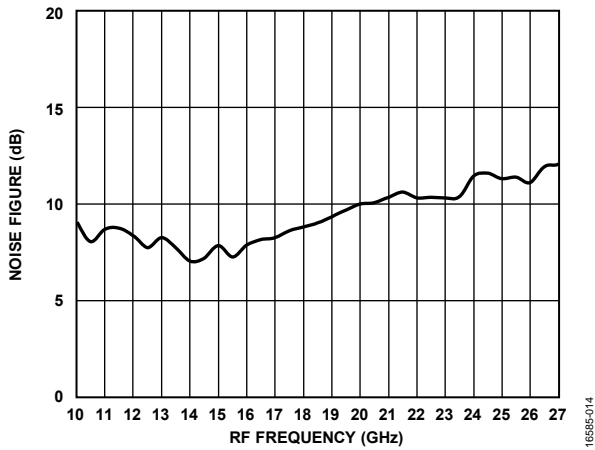

Figure 14. Noise Figure vs. RF Frequency

UPCONVERTER, UPPER SIDEBAND, IF = 1000 MHz

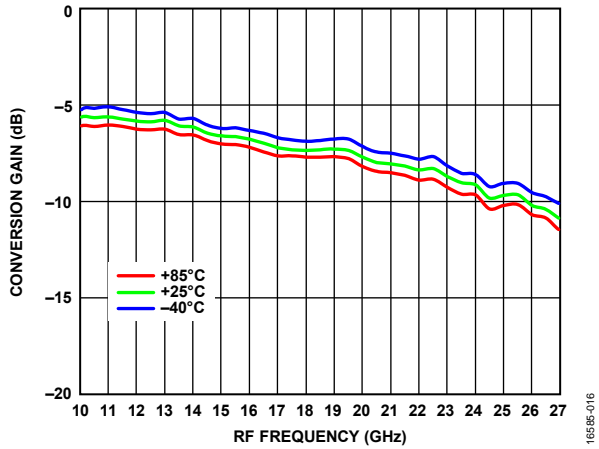

Figure 16. Conversion Gain vs. RF Frequency at Various Temperatures, LO Drive = 13 dBm

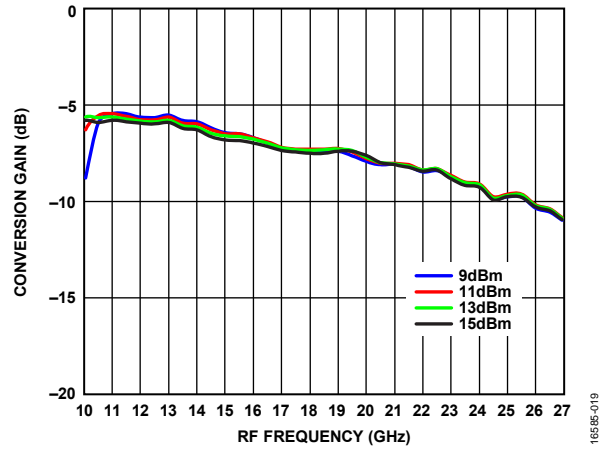

Figure 19. Conversion Gain vs. RF Frequency at Various LO Powers

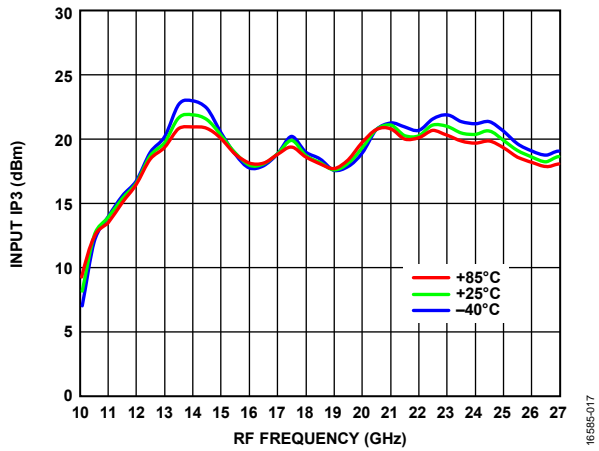

Figure 17. Input IP3 vs. RF Frequency at Various Temperatures, LO Drive = 13 dBm

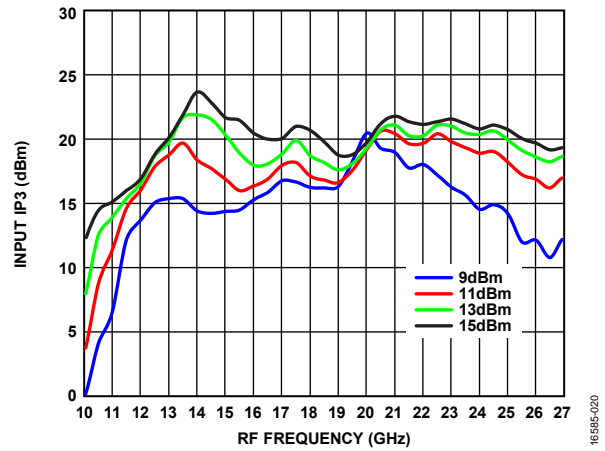

Figure 20. Input IP3 vs. RF Frequency at Various LO Powers

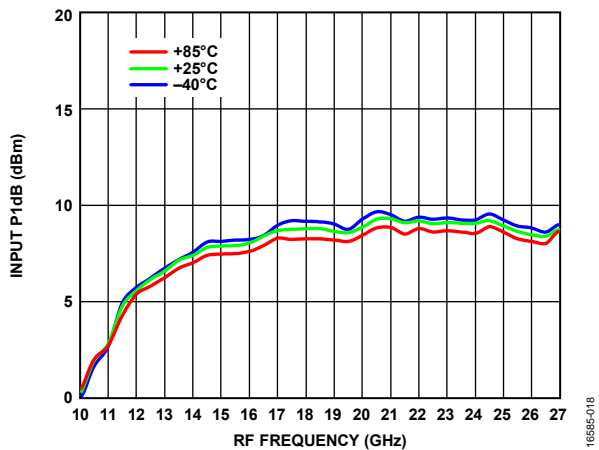

Figure 18. Input P1dB vs. RF Frequency at Various Temperatures, LO Drive = 13 dBm

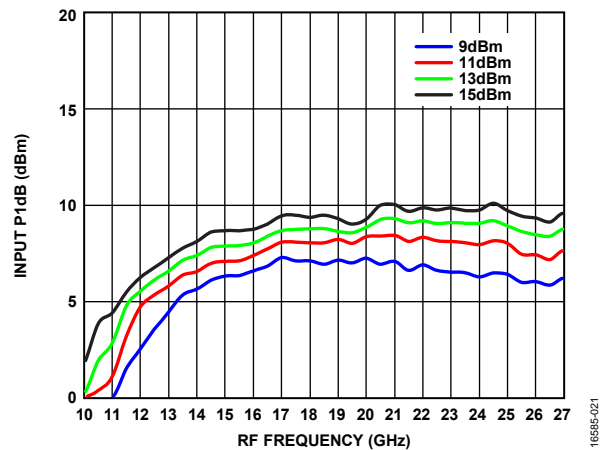

Figure 21. Input P1dB vs. RF Frequency at Various LO Powers

ISOLATION AND RETURN LOSS

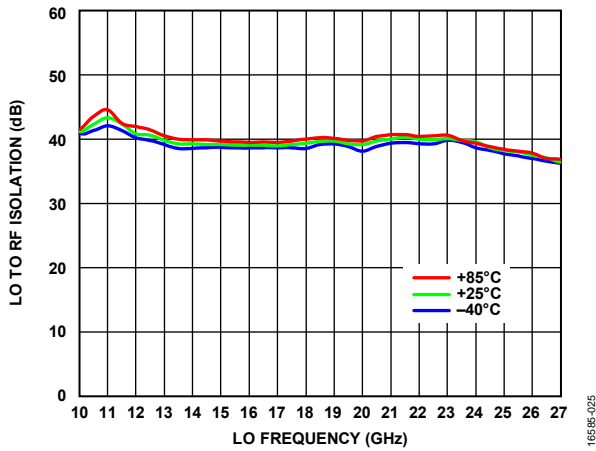

Figure 22. LO to RF Isolation vs. LO Frequency at Various Temperatures

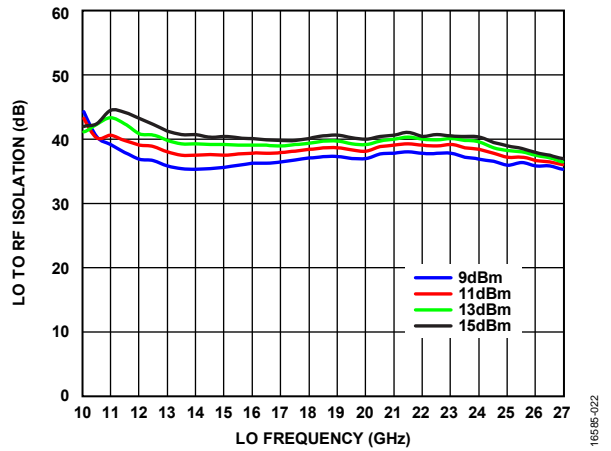

Figure 25. LO to RF Isolation vs. LO Frequency at Various LO Drives

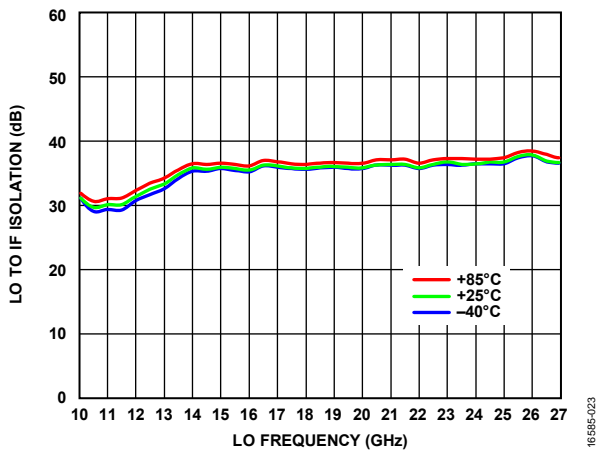

Figure 23. LO to IF Isolation vs. LO Frequency at Various Temperatures

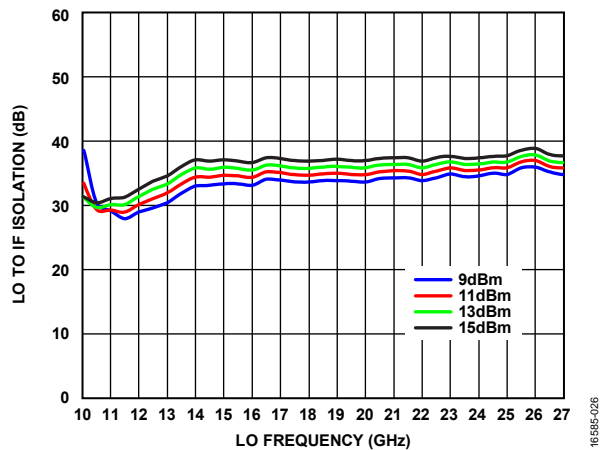

Figure 26. LO to IF Isolation vs. LO Frequency at Various LO Drives

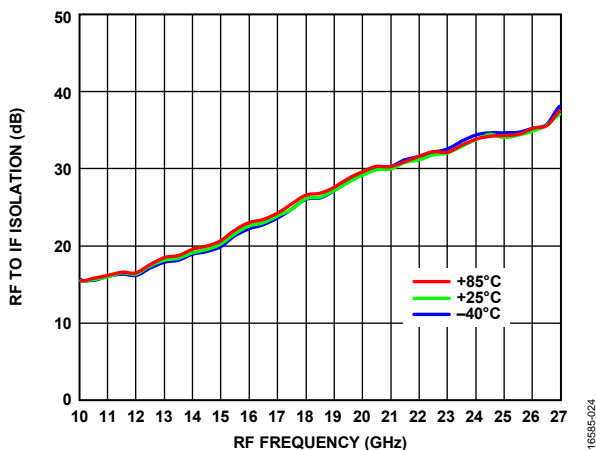

Figure 24. RF to IF Isolation vs. RF Frequency at Various Temperatures

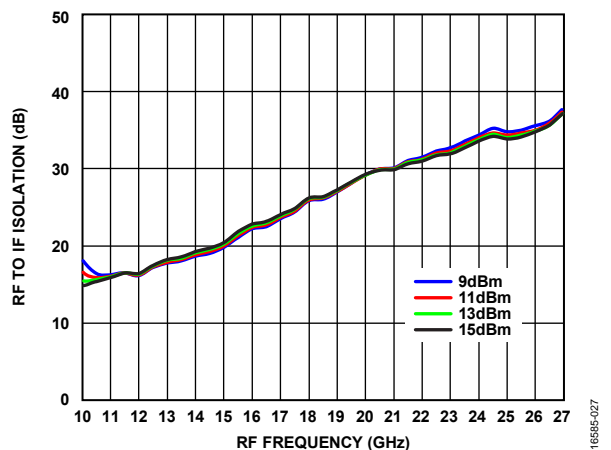

Figure 27. RF to IF Isolation vs. RF Frequency at Various LO Drives

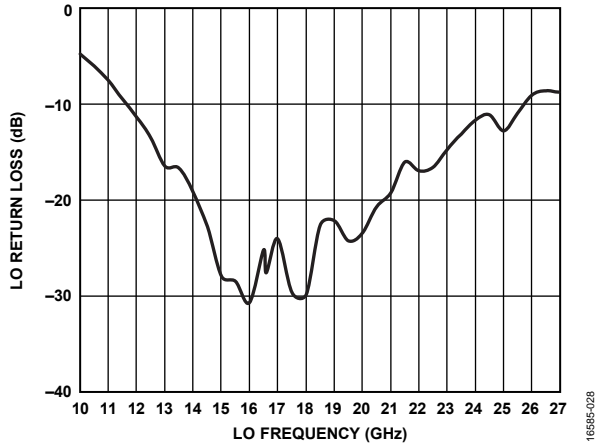

Figure 28. LO Return Loss vs. LO Frequency

16585-028

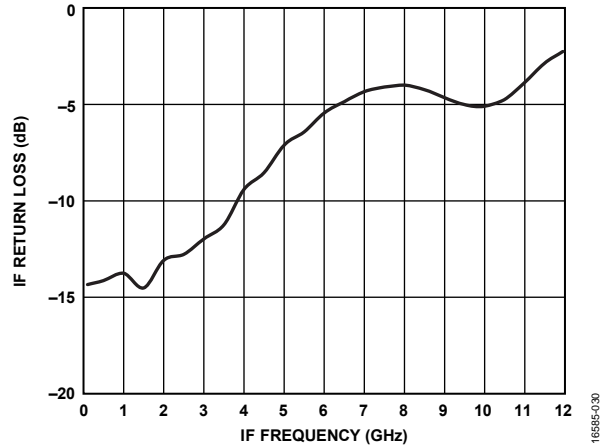

Figure 30. IF Return Loss vs. IF Frequency

16585-030

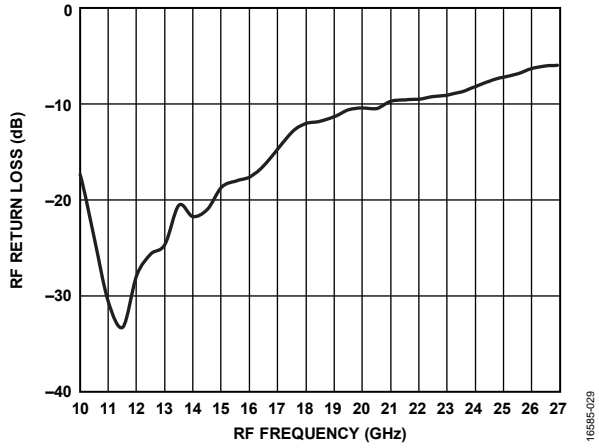

Figure 29. RF Return Loss vs. RF Frequency

16585-029

IF BANDWIDTH

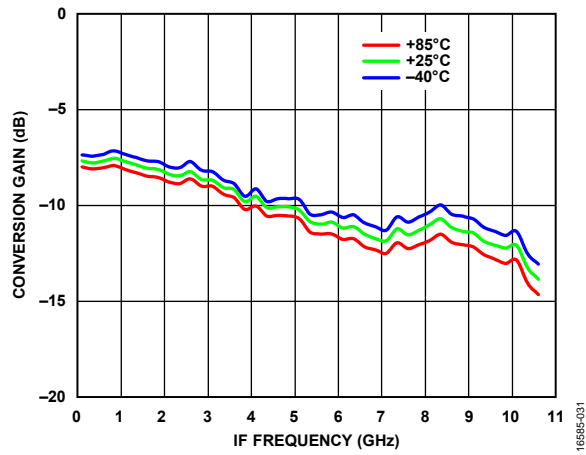

Figure 31. Conversion Gain vs. IF Frequency at Various Temperatures, LO Frequency = 18 GHz

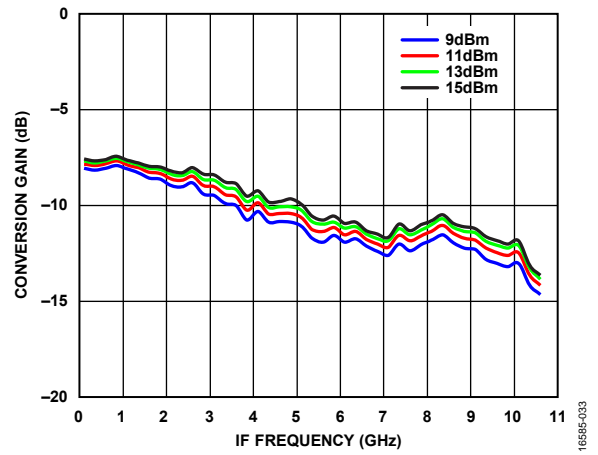

Figure 33. Conversion Gain vs. IF Frequency at Various LO Drives, LO Frequency = 18 GHz

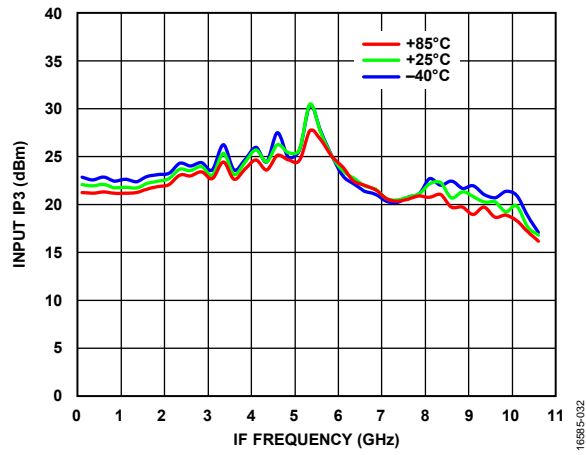

Figure 32. Input IP3 vs. IF Frequency at Various Temperatures, LO Frequency = 18 GHz

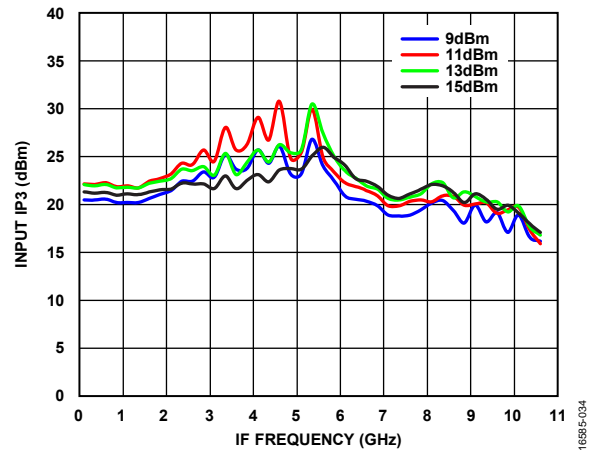

Figure 34. Input IP3 vs. IF Frequency at Various LO Drives, LO Frequency = 18 GHz

SPURIOUS PERFORMANCE

Mixer spurious products are measured in dBc from the IF output power level. Spurious values are $(M \times RF) - (N \times LO)$. N/A means not applicable.

Downconverter, $M \times N$ Spurious Outputs, $IF = 1000$ MHz

RF frequency = 21 GHz and RF input power = -10 dBm. LO frequency = 22 GHz and LO input power = 13 dBm.

		N × LO				
		0	1	2	3	4
M × RF	0	N/A	12	29	N/A	N/A
	1	27	0	89	84	N/A
	2	86	91	63	90	85
	3	N/A	87	89	73	90
	4	N/A	N/A	88	91	91

Upconverter, $M \times N$ Spurious Outputs, $IF = 1000$ MHz

RF frequency = 21 GHz and RF input power = -10 dBm. LO frequency = 22 GHz and LO input power = 13 dBm.

		N × LO				
		0	1	2	3	4
M × IF	-4	88	84	73	N/A	N/A
	-3	80	84	73	N/A	N/A
	-2	58	83	71	N/A	N/A
	-1	19	0	32	N/A	N/A
	0	N/A	5	11	N/A	N/A
	+1	19	0	31	N/A	N/A
	+2	57	82	70	N/A	N/A
	+3	80	81	72	N/A	N/A
	+4	88	79	72	N/A	N/A

THEORY OF OPERATION

The HMC260A is a general-purpose, double balanced mixer that can be used as an upconverter or a downconverter from 10 GHz to 26 GHz.

When used as a downconverter, the HMC260A downconverts RF values between 10 GHz and 26 GHz to IF values between dc and 8 GHz.

When used as an upconverter, the mixer upconverts IF values between dc and 8 GHz to RF values between 10 GHz and 26 GHz.

The mixer performs well with LO drive values of 13 dBm or above, and the device provides excellent LO to RF and LO to IF suppression due to optimized balun structures.

APPLICATIONS INFORMATION

TYPICAL APPLICATION CIRCUIT

Figure 35 shows the typical application circuit for the HMC260A. The HMC260A is a passive device and does not require any

external components. The LO and RF pins are internally dc-coupled. When IF operation is not required until dc, it is recommended to use an ac-coupled capacitor at the IF port.

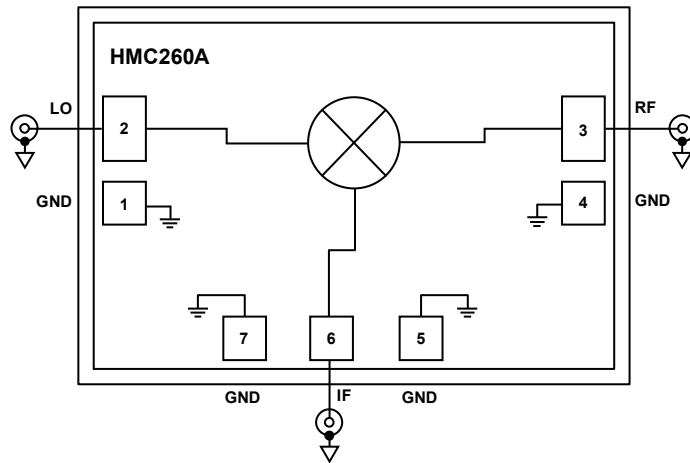

Figure 35. Typical Application Circuit

16595-035

ASSEMBLY DIAGRAM

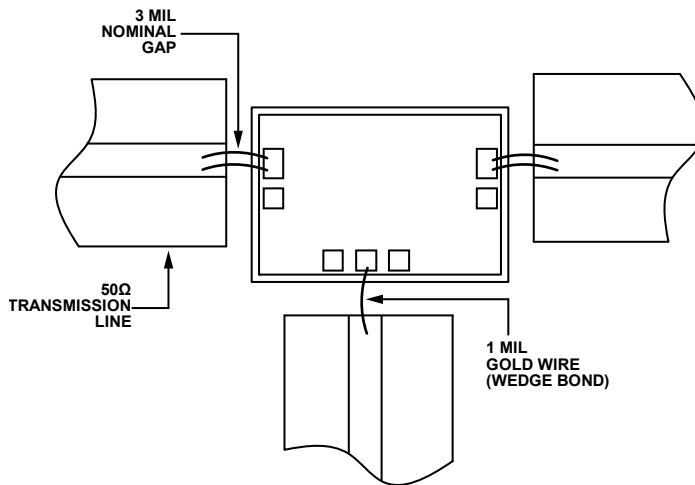

Figure 36. Assembly Diagram

16595-036

MOUNTING AND BONDING TECHNIQUES FOR MILLIMETER WAVE GAAS MMICs

Attach the die directly to the ground plane eutectically or with conductive epoxy.

To bring RF to and from the chip, use $50\ \Omega$ microstrip transmission lines on 0.127 mm (5 mil) thick alumina thin film substrates (see Figure 37).

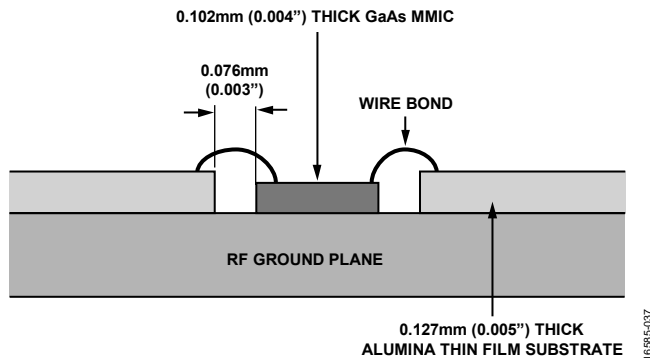

Figure 37. Routing RF Signals

If 0.254 mm (10 mil) thick alumina thin film substrates must be used, raise the die by 0.150 mm (6 mil) so that the surface of the die is coplanar with the surface of the substrate.

One way to accomplish this configuration is to attach the 0.102 mm (4 mil) thick die to a 0.150 mm (6 mil) thick molybdenum heat spreader (moly-tab), which is then attached to the ground plane (see Figure 38).

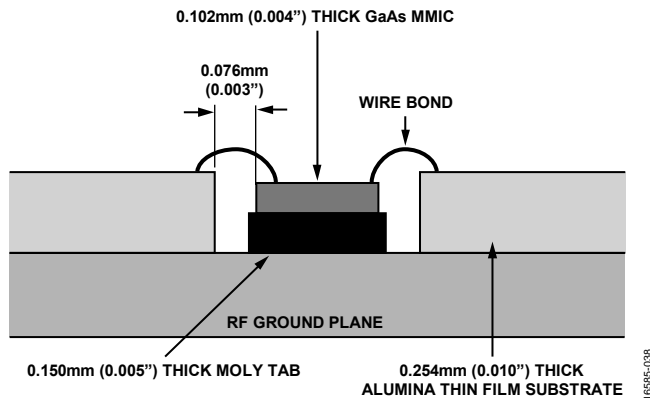

Figure 38. Routing RF Signals (Raised)

Bring microstrip substrates as close to the die as possible to minimize ribbon bond length. Typical die to substrate spacing is 0.075 mm (3 mil). Gold ribbon of a 0.075 mm (3 mil) width and a minimal length of <math><0.31\text{ mm}</math> (<math><12\text{ mil}</math>) is recommended to minimize inductance on the RF, LO, and IF ports.

HANDLING PRECAUTIONS

To avoid permanent damage, adhere to the precautions discussed in the following sections.

Storage

All bare die ship in either waffle or gel-based ESD protective containers, and are then sealed in an ESD protective bag. After opening the sealed ESD protective bag, all die must be stored in a dry nitrogen environment.

Cleanliness

Handle the chips in a clean environment. Never use liquid cleaning systems to clean the chip.

Static Sensitivity

Follow ESD precautions to protect against ESD strikes.

Transients

Suppress instrument and bias supply transients while bias is applied. To minimize inductive pickup, use shielded signal and bias cables.

General Handling

Only handle the chip on the edges using a vacuum collet or with a sharp pair of bent tweezers. Because the surface of the chip has fragile air bridges, never touch the surface of the chip with a vacuum collet, tweezers, or fingers.

MOUNTING

The chip is back metallized and can be die mounted with gold/tin (Au/Sn) eutectic performs, or with electrically conductive epoxy. The mounting surface must be clean and flat.

Eutectic Die Attach

It is best to use an 80% Au/20% Sn preform with a work surface temperature of 255°C and a tool temperature of 265°C. When hot 90% nitrogen/10% hydrogen gas is applied, maintain tool tip temperature at 290°C. Do not expose the chip to a temperature greater than 320°C for more than 20 sec. No more than 3 sec of scrubbing is required for attachment.

Epoxy Die Attach

Apply a minimum amount of epoxy to the mounting surface so that a thin epoxy fillet is observed around the perimeter of the chip after placing it into position. Cure the epoxy per the schedule provided by the manufacturer.

WIRE BONDING

RF bonds made with 3 mil \times 0.5 mil gold ribbon are recommended for the RF ports. These bonds must be thermosonically bonded with a force of 40 g to 60 g. DC bonds of 0.025 mm (1 mil) diameter, thermosonically bonded, are recommended. Create ball bonds with a force of 40 g to 50 g and wedge bonds with a force of 18 g to 22 g. Create all bonds with a nominal stage temperature of 150°C. Apply a minimum amount of ultrasonic energy to achieve reliable bonds. Keep all bonds as short as possible, preferably less than 0.31 mm (12 mil).

OUTLINE DIMENSIONS

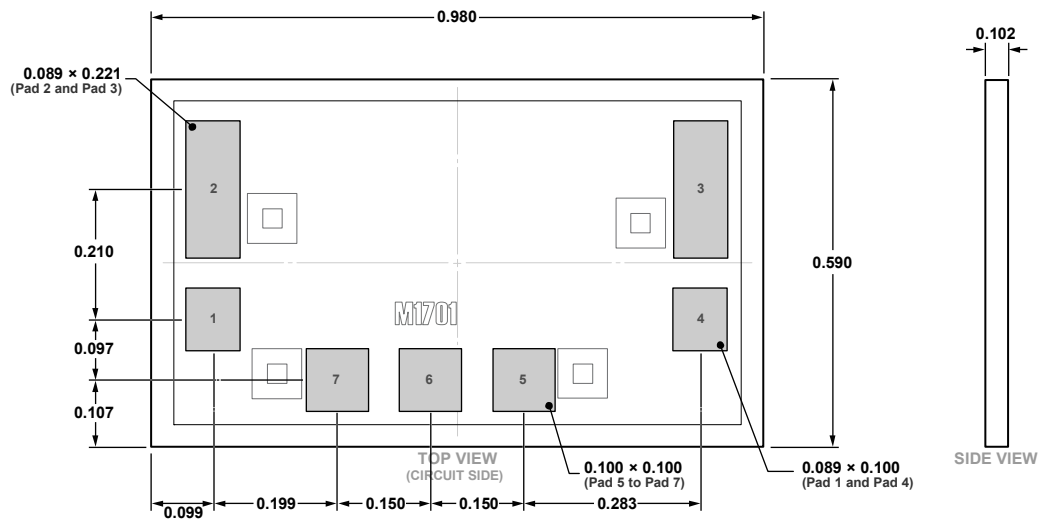

Figure 39. 7-Pad Bare Die [CHIP]
(C-7-4)
Dimensions shown in millimeters

01-02-2018-A

ORDERING GUIDE

Model ¹	Temperature Range	Package Description	Package Option
HMC260A	-55°C to +85°C	7-Pad Bare Die [CHIP]	C-7-4
HMC260A-SX	-55°C to +85°C	7-Pad Bare Die [CHIP]	C-7-4

¹ The HMC260A is an RoHS Compliant Part.