

### Typical Applications

The HMC280MS8G is ideal for:

- UNII & HiperLAN
- ISM

### Features

- Psat Output Power: +24 dBm
- Output IP3: +38 dBm
- High Gain: 18 dB
- Single Supply: +3.6V
- Ultra Small Package: MSOP8G

### Functional Diagram

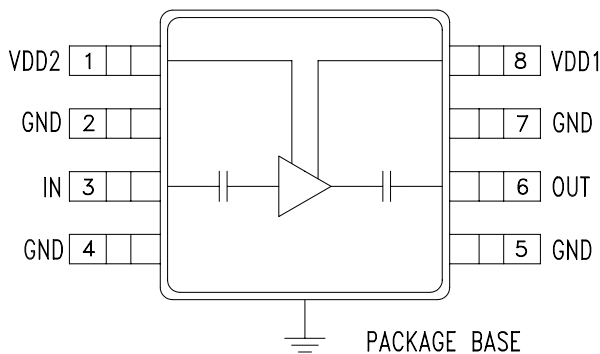

### General Description

The HMC280MS8G is a +3.6V GaAs MMIC power amplifier covering 5 to 6 GHz. The device is packaged in a low cost, surface mount 8 lead MSOP plastic package with an exposed base paddle for improved RF ground and thermal dissipation. The amplifier provides 18 dB of gain and 24 dBm Psat while operating from a single positive supply. External component requirements are minimal with the amplifier occupying less than 0.023 sq. in. (14.6 sq. mm). All data is taken with the amplifier assembled into a 50 ohm test fixture with the exposed base paddle connected to RF ground. For transmit / receive applications use with either the HMC223MS8 or HMC224MS8 SPDT switches.

### Electrical Specifications, $T_A = +25^\circ C$ , $V_{dd} = +3.6V$

| Parameter   | Min.                           | Typ.     | Max.     | Units |
|---|--------------------------------|----------|----------|-------|
| Frequency Range   | 5.0 - 6.0                      |          |          | GHz   |
| Gain  | 14                             | 19       | 23       | dB    |
| Gain Flatness   |                                | ±1.0     |          | dB    |
| Input Return Loss   | 8                              | 12       |          | dB    |
| Reverse Isolation   | 40                             | 44       |          | dB    |
| Output Power for 1 dB Compression (P1dB)  | 5.0 - 5.5 Ghz<br>5.0 - 6.0 Ghz | 20<br>18 | 23<br>22 | dBm   |
| Saturated Output Power (Psat)   | 21                             | 24       |          | dBm   |
| Output Third Order Intercept (IP3)  | 33                             | 38       |          | dBm   |
| Noise Figure  |                                | 13       |          | dB    |
| Supply Current (I <sub>dd</sub> )(V <sub>dd1</sub> = V <sub>dd2</sub> = +3.6 Vdc) |                                | 480      |          | mA    |

## GaAs MMIC POWER AMPLIFIER 5.0 - 6.0 GHz

**Broadband Gain & Return Loss**

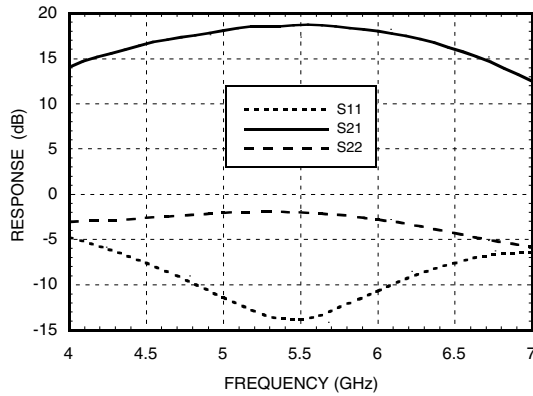

**Gain vs. Temperature @ 3.6V**

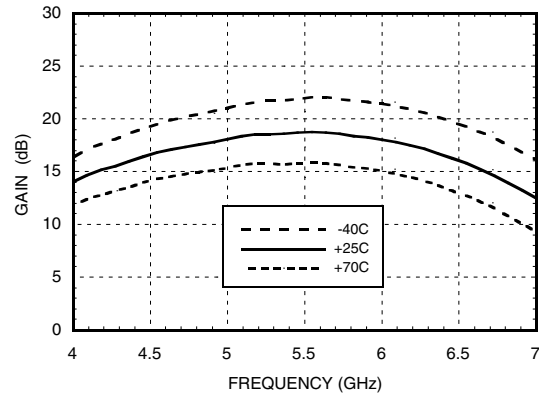

**Psat vs. Supply Voltage**

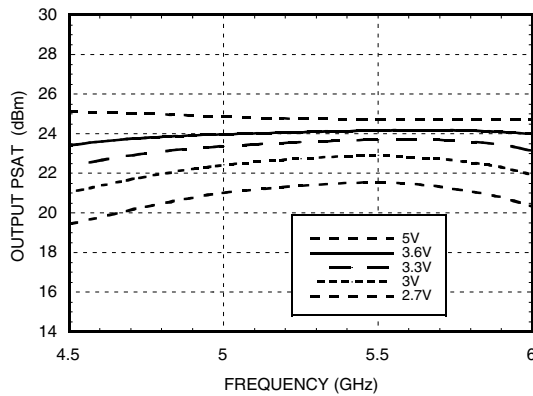

**Psat vs. Temperature @ 3.6V**

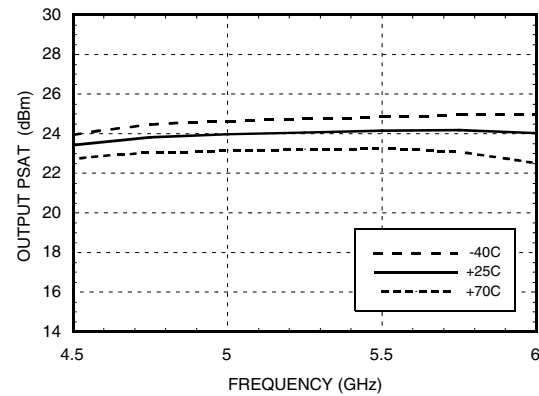

**P1dB vs. Supply Voltage**

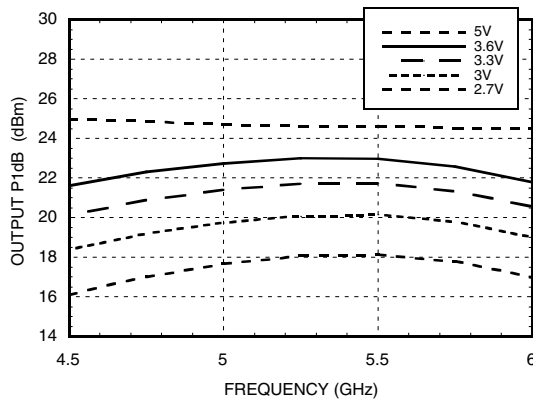

**P1dB vs. Temperature @ 3.6V**

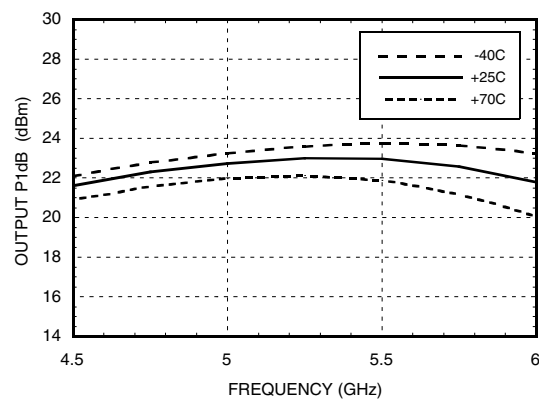

## GaAs MMIC POWER AMPLIFIER 5.0 - 6.0 GHz

8

AMPLIFIERS - SMT

**Power Compression @ 5.25 GHz**

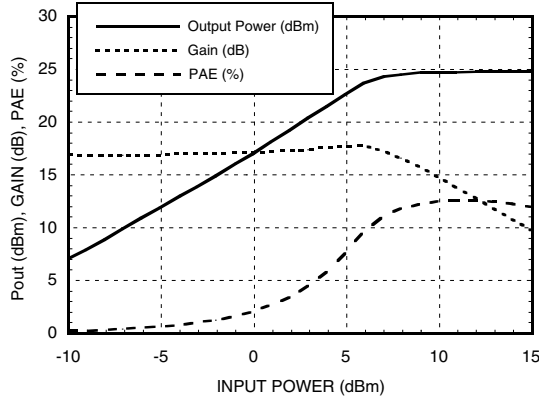

**Output IP3 vs Supply Voltage @ 6.0 GHz**

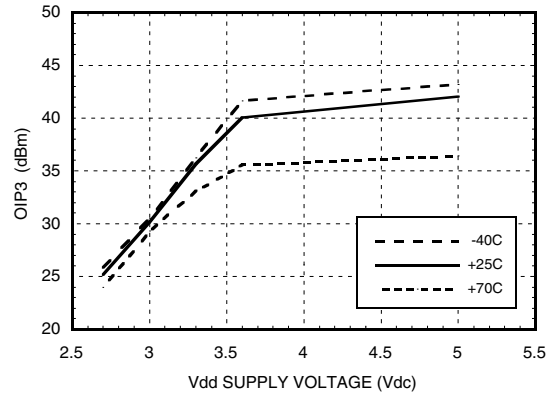

**Output IP3 vs. Temperature @ 3.6V**

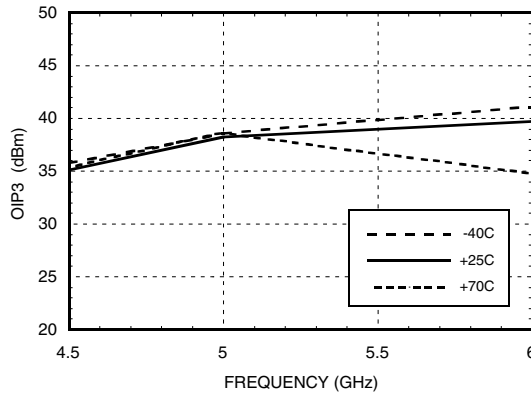

**Output IP3 vs. Temperature @ 5.0V**

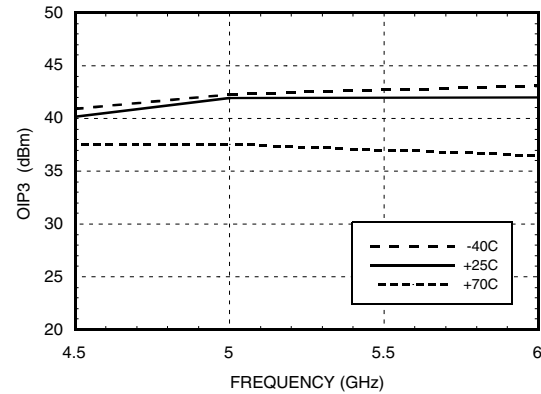

**Reverse Isolation @ 3.6V**

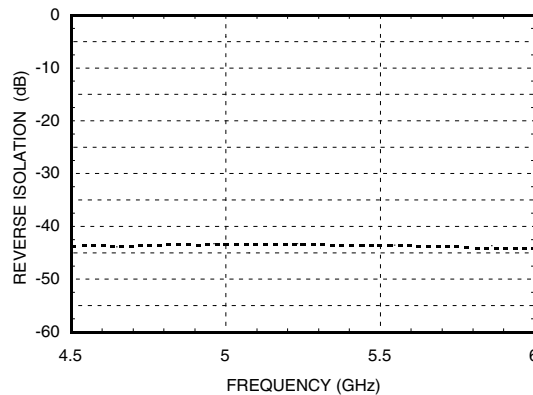

### Absolute Maximum Ratings

|   |                |
|---|----------------|
| Drain Bias Voltage (Vdd1, Vdd2)                               | +8.0 Vdc       |
| RF Input Power (RFIn) (Vdd = +3.6 Vdc)                        | +20 dBm        |
| Channel Temperature   | 150 °C         |
| Continuous Pdiss (T = 85 °C)<br>(derate 41 mW/°C above 85 °C) | 2.67 W         |
| Thermal Resistance<br>(channel to ground paddle)              | 24.3 °C/W      |
| Storage Temperature   | -65 to +150 °C |
| Operating Temperature   | -55 to +85 °C  |

### Outline Drawing

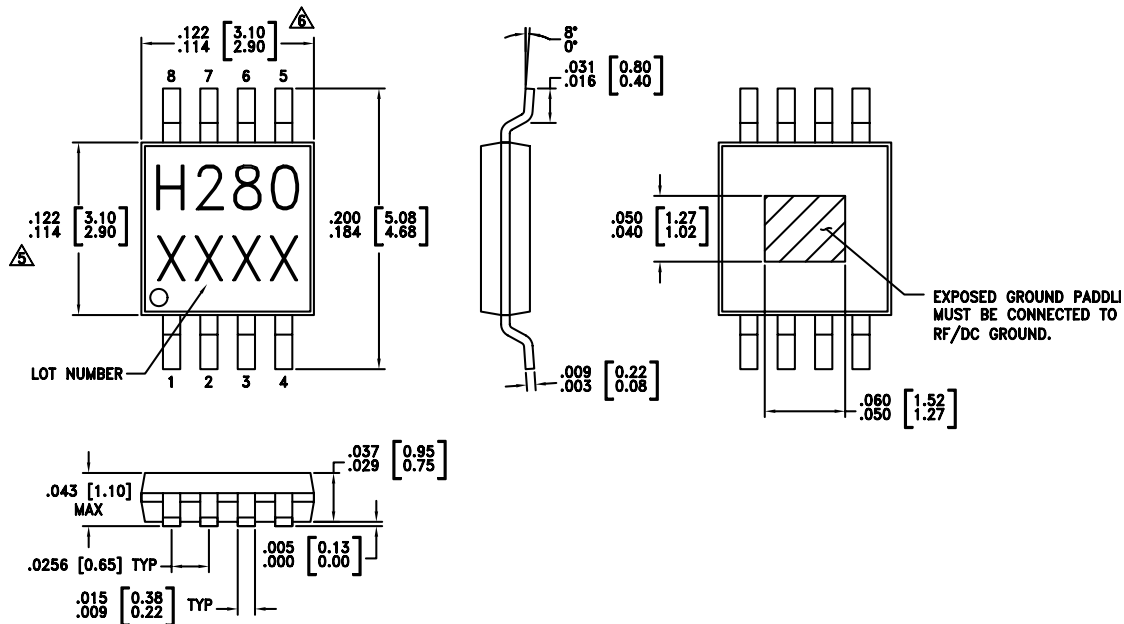

#### NOTES:

1. PACKAGE BODY MATERIAL: LOW STRESS INJECTION MOLDED PLASTIC SILICA AND SILICON IMPREGNATED.
2. LEADFRAME MATERIAL: COPPER ALLOY
3. LEADFRAME PLATING: Sn/Pb SOLDER
4. DIMENSIONS ARE IN INCHES [MILLIMETERS].
5. DIMENSION DOES NOT INCLUDE MOLDFLASH OF 0.15mm PER SIDE.
6. DIMENSION DOES NOT INCLUDE MOLDFLASH OF 0.25mm PER SIDE.
7. ALL GROUND LEADS AND GROUND PADDLE MUST BE SOLDERED TO PCB RF GROUND.

### Recommended PCB Layout

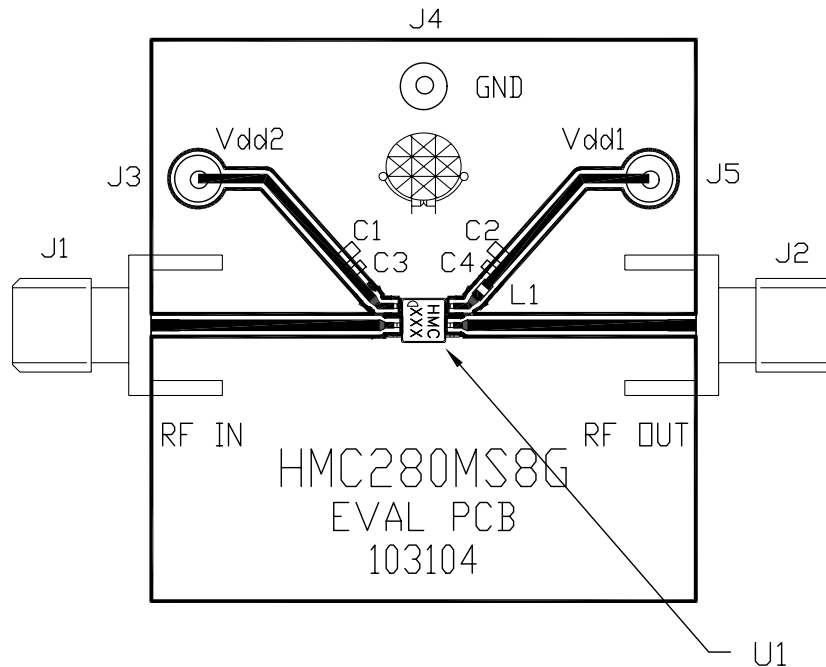

### List of Material

| Item                                | Description                  |
|-------------------------------------|------------------------------|
| J1, J2                              | PC Mount SMA Connector       |
| J3, J4, J5                          | DC Pins                      |
| C1, C2                              | 1000 pF Capacitor, 0603 Pkg. |
| C3, C4                              | 100 pF Capacitor, 0402 Pkg.  |
| L1                                  | 3.9 nH Inductor, 0402 Pkg.   |
| U1                                  | HMC280MS8G Amplifier         |
| PCB*                                | 103104 Evaluation Board      |
| *Circuit Board Material: Roger 4350 |                              |

The circuit board used in the final application should use RF circuit design techniques. Signal lines should have 50 ohm impedance while the package ground leads and exposed paddle should be connected directly to the ground plane similar to that shown. A sufficient number of via holes should be used to connect the top and bottom ground planes. The evaluation circuit board shown is available from Hittite upon request.

### Application Circuit

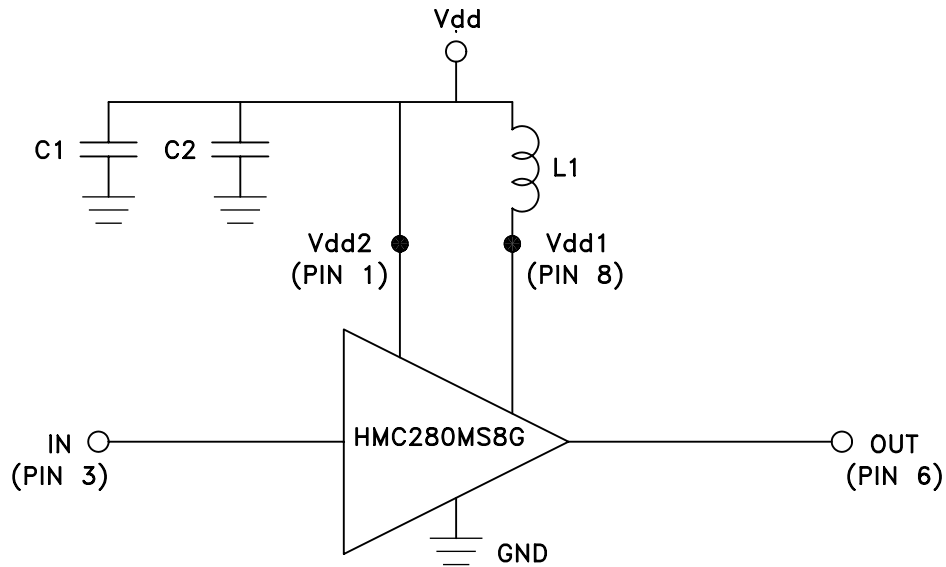

Note 1: Vdd1 and Vdd2 may be connected to a common Vdd feed after RF choke.

| Recommended Component Values |         |
|------------------------------|---------|
| L1                           | 3.9 nH  |
| C1                           | 1000 pF |
| C2                           | 100 pF  |

Note 2: L1 should be located  $\leq 0.020''$  (0.508 mm) from pin 8 (Vdd1).