

## FEATURES

- Passive: no dc bias required**
- Conversion loss (downconverter): 9 dB typical at 14 GHz to 30 GHz**
- Single-sideband noise figure: 11 dB typical at 14 GHz to 30 GHz**
- Input IP3 (downconverter): 20 dBm typical at 14 GHz to 30 GHz**
- Input P1dB compression point (downconverter): 12 dBm typical at 14 GHz to 30 GHz**
- Input IP2: 53 dBm typical at 14 GHz to 30 GHz**
- RF to IF isolation: 30 dB typical at 14 GHz to 30 GHz**
- LO to RF isolation: 46 dB typical at 14 GHz to 30 GHz**
- LO to IF isolation: 34 dB typical at 14 GHz to 30 GHz**
- RF return loss: 10 dB typical at 14 GHz to 30 GHz**
- LO return loss: 9 dB typical at 14 GHz to 30 GHz**
- Wide IF frequency range: dc to 8 GHz**
- Small size: 7-pad bare die [CHIP]**

## APPLICATIONS

- Microwave and very small aperture terminal (VSAT) radios**
- Test equipment**
- Point to point radios**
- Military electronic warfare (EW); electronic countermeasure (ECM); and command, control, communications and intelligence (C3I)**

## GENERAL DESCRIPTION

The HMC292A chip is a miniature, passive, gallium arsenide (GaAs), monolithic microwave integrated circuit (MMIC), double balanced mixer that can be used as an upconverter or a downconverter within the 14 GHz to 32 GHz RF frequency range with a small chip area. Excellent isolations are provided by an on-chip balun that requires no external components and no dc bias.

## FUNCTIONAL BLOCK DIAGRAM

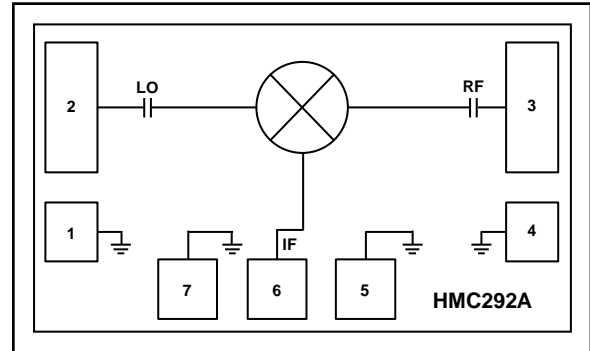

Figure 1.

All data is measured with the chip in a 50  $\Omega$  test fixture connected via 0.076 mm (0.003 inches) ribbon bonds of minimal length <0.31 mm (<0.012 inches).

**TABLE OF CONTENTS**

Features .....	1	Upconverter Performance.....	9
Applications.....	1	Isolation Performance.....	10
Functional Block Diagram .....	1	Return Loss Performance.....	11
General Description .....	1	IF Bandwidth—Downconverter.....	12
Revision History .....	2	Spurious and Harmonics Performance .....	13
Specifications.....	3	Theory of Operation .....	14
14 GHz to 30 GHz RF Range .....	3	Applications Information.....	15
30 GHz to 32 GHz RF Range.....	4	Assembly Diagram .....	15
Absolute Maximum Ratings.....	5	Mounting and Bonding Techniques for Millimeter Wave GaAs MMICs.....	16
Thermal Resistance .....	5	Handling Precautions .....	16
ESD Caution.....	5	Mounting.....	16
Pin Configuration and Function Descriptions.....	6	Wire Bonding.....	16
Interface Schematics.....	6	Outline Dimensions .....	17
Typical Performance Characteristics .....	7	Ordering Guide .....	17
Downconverter Performance.....	7		
Downconverter Input P1dB and Input IP2 Performance .....	8		

**REVISION HISTORY**

4/2018—Revision 0: Initial Version

## SPECIFICATIONS

$T_A = 25^\circ\text{C}$ , intermediate frequency (IF) = 1 GHz, radio frequency (RF) = -10 dBm, local oscillator (LO) = 13 dBm, upper sideband. All measurements performed as a downconverter, unless otherwise noted.

### 14 GHz TO 30 GHz RF RANGE

Table 1.

Parameter	Symbol	Min	Typ	Max	Unit
RF RANGE	RF	14		30	GHz
LOCAL OSCILLATOR	LO				
Frequency		14		30	GHz
Drive Level			13		dBm
INTERMEDIATE FREQUENCY	IF	DC		8	GHz
RF PERFORMANCE AS DOWNCONVERTER					
Conversion Loss			9	11	dB
Single Sideband (SSB) Noise Figure	NF		11		dB
Input Third-Order Intercept	IP3	15	20		dBm
Input 1 dB Compression Point	P1dB		12		dBm
Input Second-Order Intercept	IP2		53		dBm
RF PERFORMANCE AS UPCONVERTER					
Conversion Loss			8		dB
Input Third-Order Intercept	IP3		18		dBm
Input 1 dB Compression Point	P1dB		9		dBm
ISOLATION PERFORMANCE					
RF to IF		17	30		dBm
LO to RF			46		dBm
LO to IF		28	34		dBm
RETURN LOSS PERFORMANCE					
RF			10		dB
LO			9		dB

**30 GHz TO 32 GHz RF RANGE**

Table 2.

Parameter	Symbol	Min	Typ	Max	Unit
RF RANGE	RF	30		32	GHz
LOCAL OSCILLATOR	LO				
Frequency		30		32	GHz
Drive Level			13		dBm
INTERMEDIATE FREQUENCY	IF	DC		8	GHz
RF PERFORMANCE AS DOWNCONVERTER					
Conversion Loss			11	12.5	dB
Single Sideband (SSB) Noise Figure	NF		14		dB
Input Third-Order Intercept	IP3	17	21		dBm
Input 1 dB Compression Point	P1dB		14		dBm
Input Second-Order Intercept	IP2		65		dBm
RF PERFORMANCE AS UPCONVERTER					
Conversion Loss			11		dB
Input Third-Order Intercept	IP3		17		dBm
Input 1 dB Compression Point	P1dB		8.5		dBm
ISOLATION PERFORMANCE					
RF to IF		20	39		dBm
LO to RF			51		dBm
LO to IF		31	38		dBm
RETURN LOSS PERFORMANCE					
RF			7		dB
LO			13		dB

## ABSOLUTE MAXIMUM RATINGS

Table 3.

Parameter	Rating
RF Input Power	18 dBm
LO Input Power	26 dBm
IF Input Power	18 dBm
Maximum Junction Temperature	175°C
Continuous Power Dissipation, P <sub>DISS</sub> (T <sub>A</sub> = 85°C, Derate 5.12 mW/°C Above 85°C)	460 mW
Operating Temperature Range	–55°C to +85°C
Storage Temperature Range	–65°C to +150°C
Electrostatic Discharge (ESD) Sensitivity	
Human Body Model (HBM)	500 V
Field Induced Charged Device Model (FICDM)	500 V

Stresses at or above those listed under Absolute Maximum Ratings may cause permanent damage to the product. This is a stress rating only; functional operation of the product at these or any other conditions above those indicated in the operational section of this specification is not implied. Operation beyond the maximum operating conditions for extended periods may affect product reliability.

## THERMAL RESISTANCE

Thermal performance is directly linked to printed circuit board (PCB) design and operating environment. Careful attention to PCB thermal design is required.

$\theta_{JC}$  is the junction to case thermal resistance.

Table 4. Thermal Resistance

Package Type	$\theta_{JC}$	Unit
CHIP	195	°C/W

## ESD CAUTION



**ESD (electrostatic discharge) sensitive device.** Charged devices and circuit boards can discharge without detection. Although this product features patented or proprietary protection circuitry, damage may occur on devices subjected to high energy ESD. Therefore, proper ESD precautions should be taken to avoid performance degradation or loss of functionality.

## PIN CONFIGURATION AND FUNCTION DESCRIPTIONS

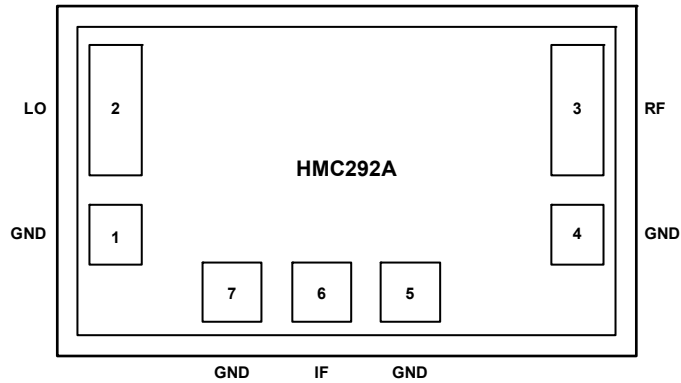

Figure 2. Pin Configuration

Table 5. Pin Function Descriptions

Pin No.	Mnemonic	Description
1, 4, 5, 7	GND	Ground. These pads must be connected to RF/dc ground. See Figure 3 for the interface schematic.
2	LO	Local Oscillator Port. This pad is ac-coupled and matched to 50 Ω. See Figure 4 for the interface schematic.
3	RF	Radio Frequency Port. This pad is ac-coupled and matched to 50 Ω. See Figure 5 for the interface schematic.
6	IF	Intermediate Frequency Port. This pad is dc-coupled. For applications, not requiring operation to dc, dc block this port externally using a series capacitor of a value chosen to pass the necessary IF frequency range. See Figure 6 for the interface schematic.

### INTERFACE SCHEMATICS



Figure 3. GND Interface Schematic

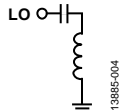

Figure 4. LO Interface Schematic

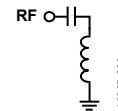

Figure 5. RF Interface Schematic

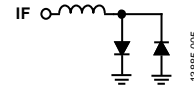

Figure 6. IF Interface Schematic

# TYPICAL PERFORMANCE CHARACTERISTICS

## DOWNCONVERTER PERFORMANCE

Downconverter performance at IF = 1 GHz, upper sideband (low-side LO).

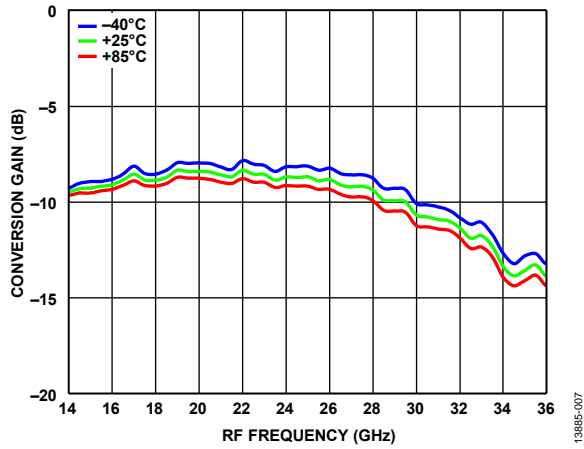

Figure 7. Conversion Gain vs. RF Frequency at Various Temperatures, LO = 13 dBm

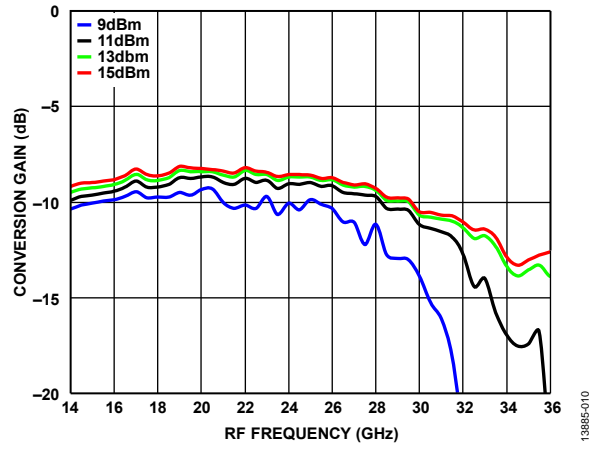

Figure 10. Conversion Gain vs. RF Frequency at Various LO Power Levels,  $T_A = 25^\circ\text{C}$

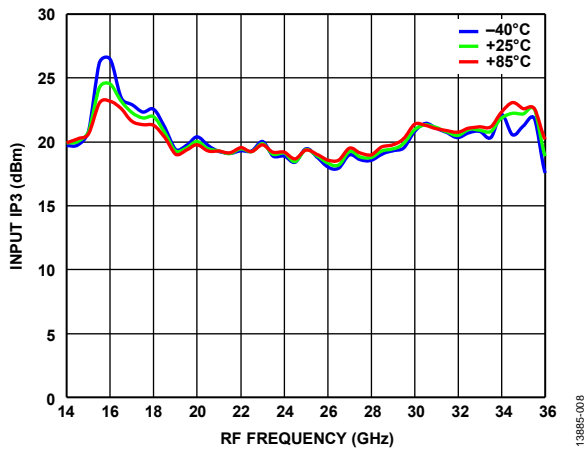

Figure 8. Input IP3 vs. RF Frequency at Various Temperatures, LO = 13 dBm

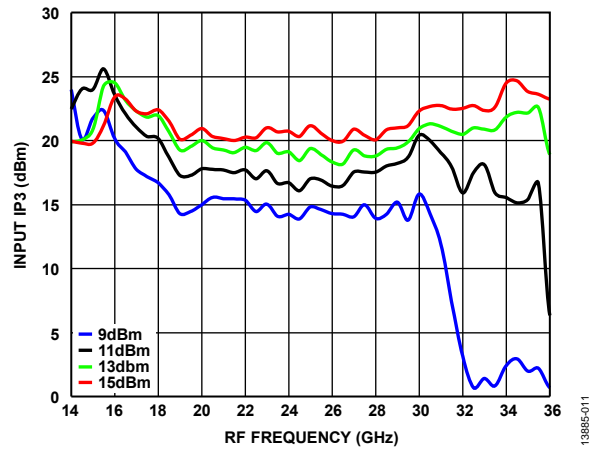

Figure 11. Input IP3 vs. RF Frequency at Various LO Power Levels,  $T_A = 25^\circ\text{C}$

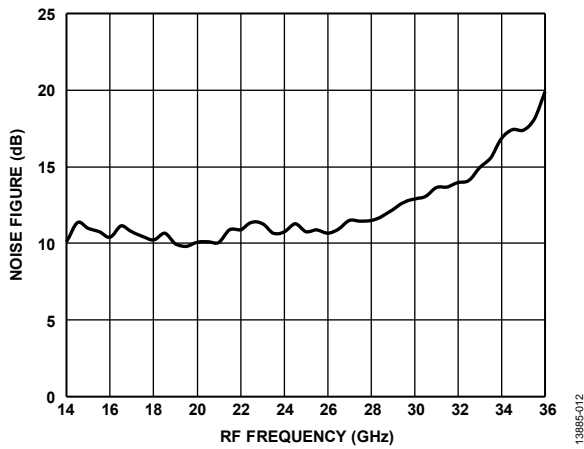

Figure 9. Noise Figure vs. RF Frequency at  $T_A = 25^\circ\text{C}$ , LO = 13 dBm (No Amplifier)

**DOWNCONVERTER INPUT P1dB AND INPUT IP2 PERFORMANCE**

IF = 1 GHz, upper sideband (low-side LO).

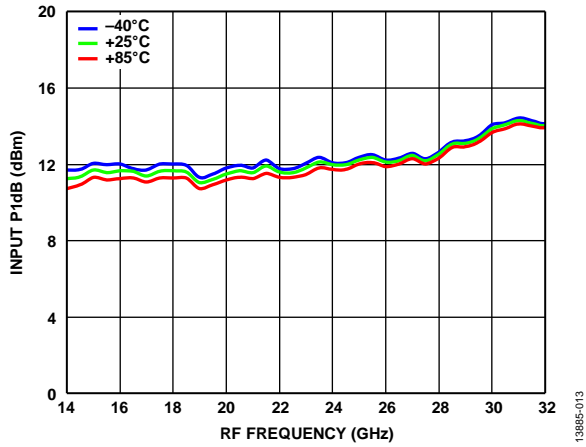

Figure 12. Input P1dB vs. RF Frequency at Various Temperatures, LO = 13 dBm

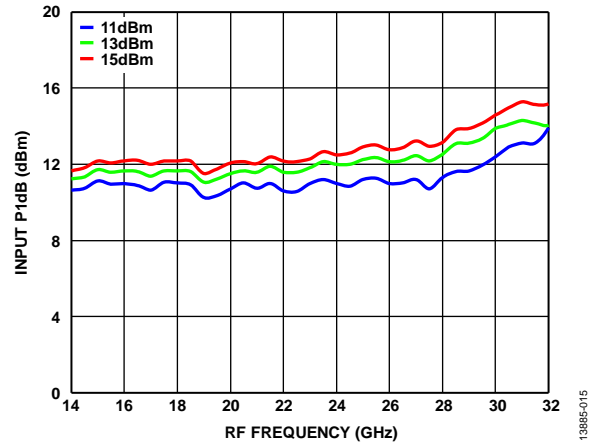

Figure 14. Input P1dB vs. RF Frequency at Various LO Power Levels, TA = 25°C

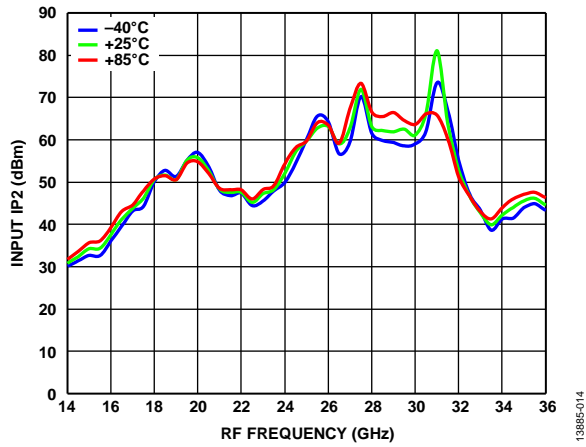

Figure 13. Input IP2 vs. RF Frequency at Various Temperatures, LO = 13 dBm

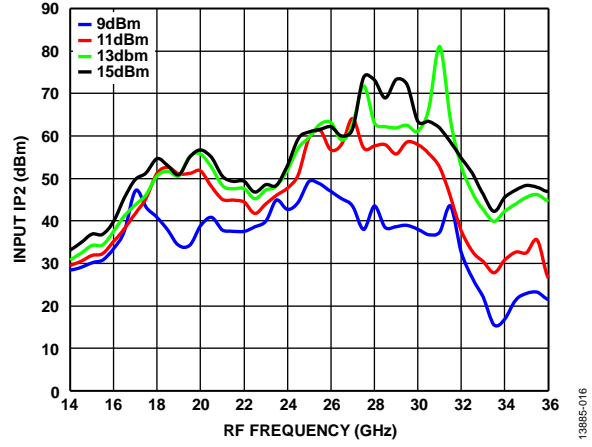

Figure 15. Input IP2 vs. RF Frequency at Various LO Power Levels, TA = 25°C



**UPCONVERTER PERFORMANCE**

Upconverter performance at input intermediate frequency (IF<sub>IN</sub>) = 1 GHz, upper sideband (low-side LO).

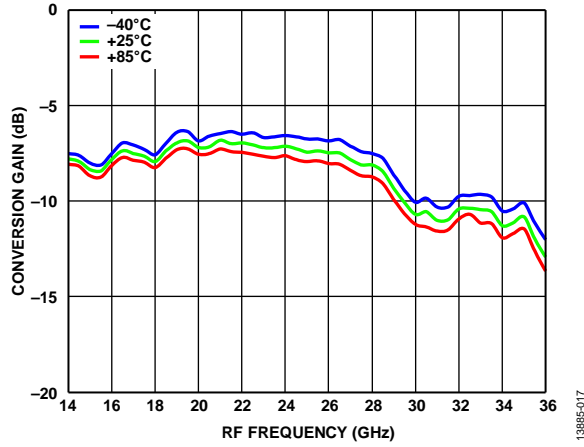

Figure 16. Conversion Gain vs. RF Frequency at Various Temperatures, LO = 13 dBm

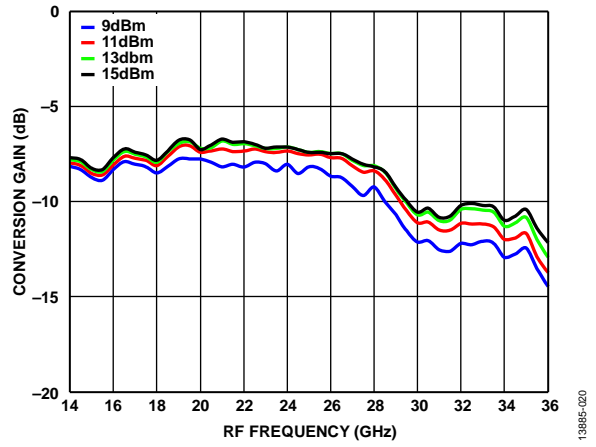

Figure 19. Conversion Gain vs. RF Frequency at Various LO Power Levels, T<sub>A</sub> = 25°C

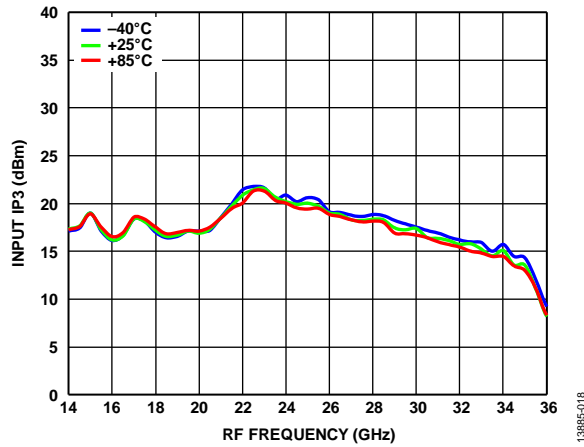

Figure 17. Input IP3 vs. RF Frequency at Various Temperatures, LO = 13 dBm

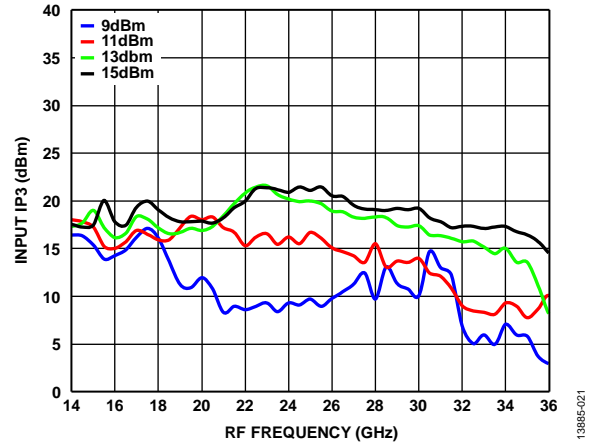

Figure 20. Input IP3 vs. RF Frequency at Various LO Power Levels, T<sub>A</sub> = 25°C

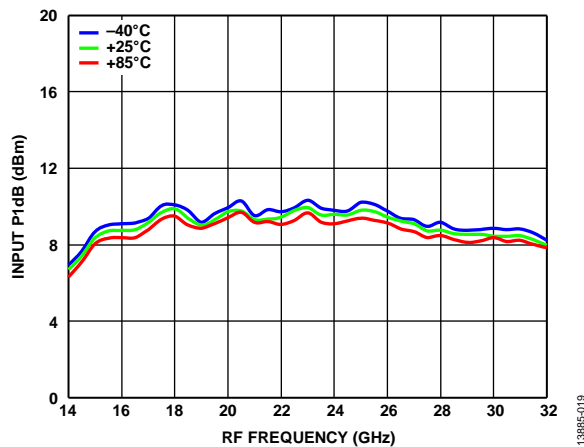

Figure 18. Input P1dB vs. RF Frequency at Various Temperatures, LO = 13 dBm

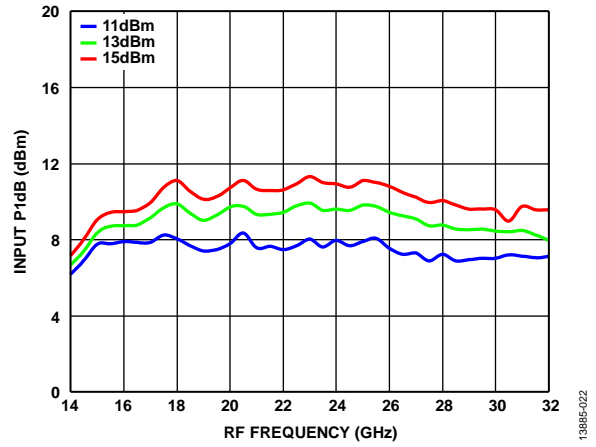

Figure 21. Input P1dB vs. RF Frequency at Various LO Power Levels, T<sub>A</sub> = 25°C

**ISOLATION PERFORMANCE**

IF = 1 GHz, upper sideband (low-side LO).

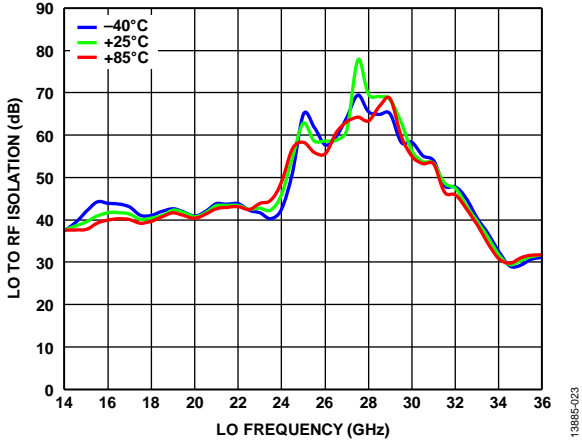

Figure 22. LO to RF Isolation vs. LO Frequency at Various Temperatures, LO = 13 dBm

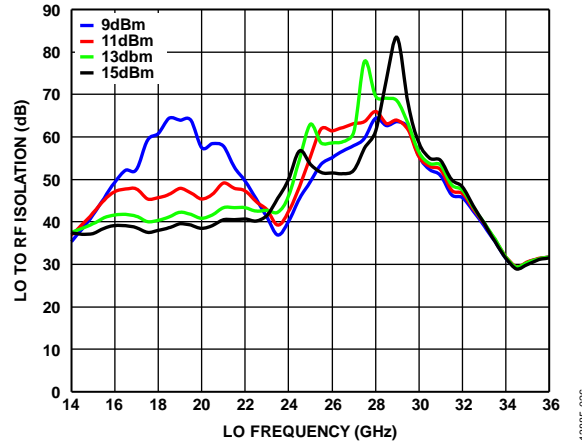

Figure 25. LO to RF Isolation vs. LO Frequency at Various LO Power Levels, TA = 25°C

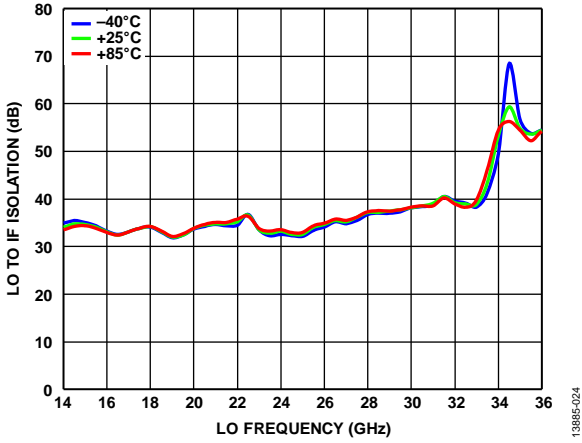

Figure 23. LO to IF Isolation vs. LO Frequency at Various Temperatures, LO = 13 dBm

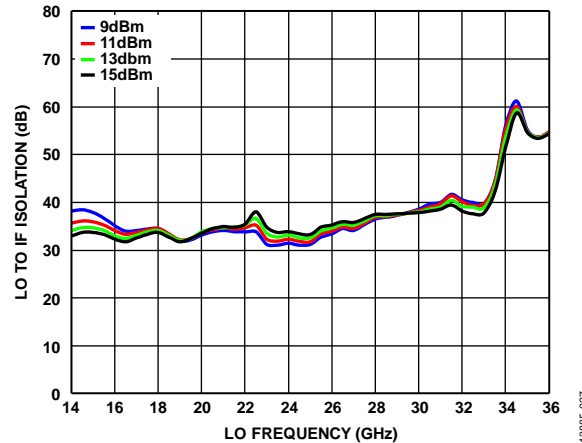

Figure 26. LO to IF Isolation vs. LO Frequency at Various LO Power Levels, TA = 25°C

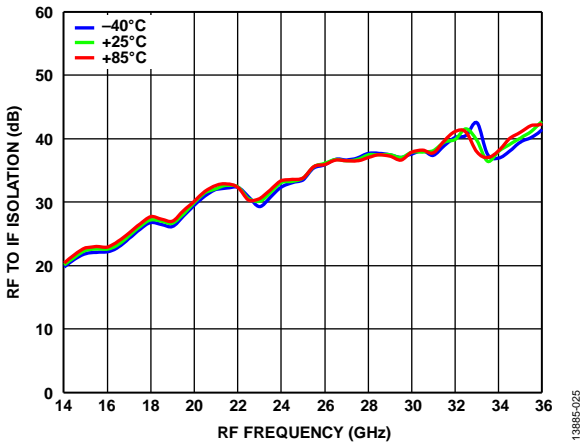

Figure 24. RF to IF Isolation vs. RF Frequency at Various Temperatures, LO = 13 dBm

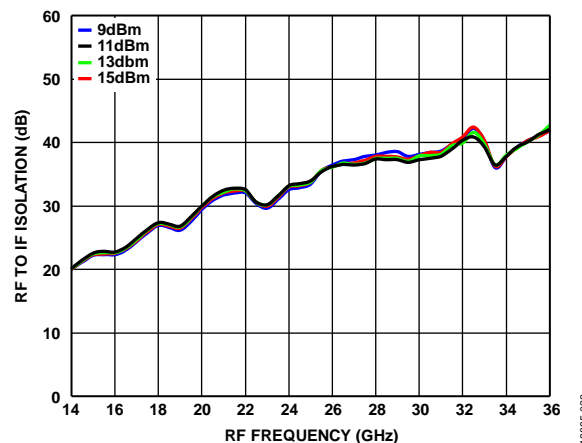

Figure 27. RF to IF Isolation vs. RF Frequency at Various LO Power Levels, TA = 25°C

RETURN LOSS PERFORMANCE

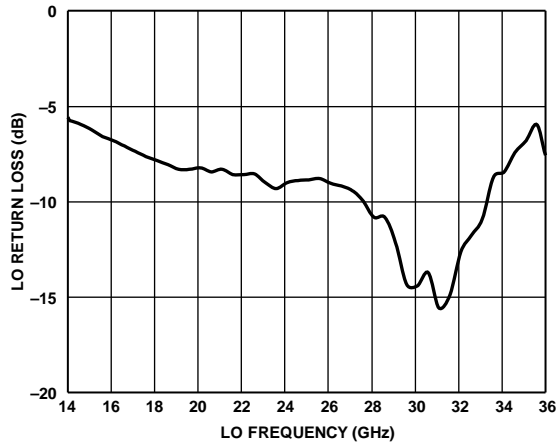

Figure 28. LO Return Loss vs. LO Frequency  
LO = 13 dBm

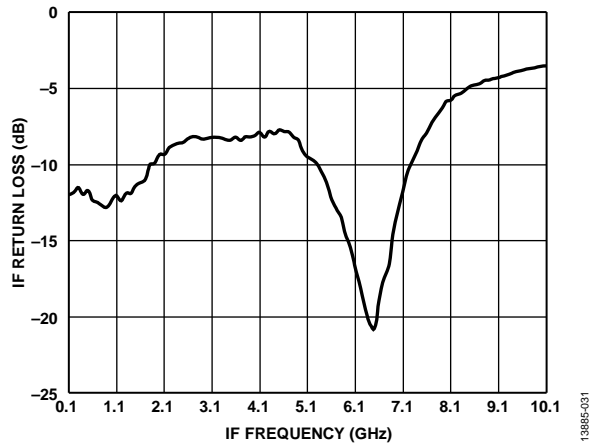

Figure 30. IF Return Loss vs. IF Frequency  
LO = 13 dBm at 17 GHz

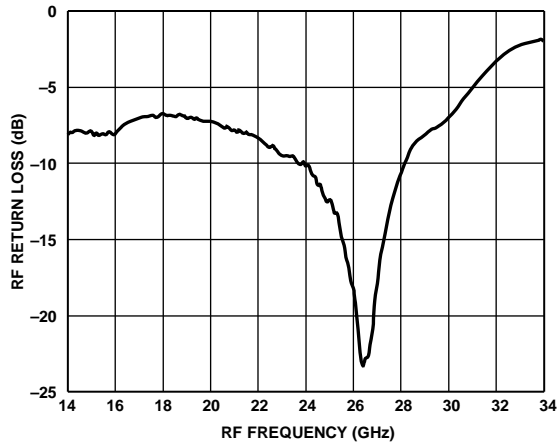

Figure 29. RF Return Loss vs. RF Frequency  
LO = 13 dBm at 17 GHz

13885-029

13885-031

13885-030

**IF BANDWIDTH—DOWNCONVERTER**

Upper sideband, LO frequency = 20 GHz.

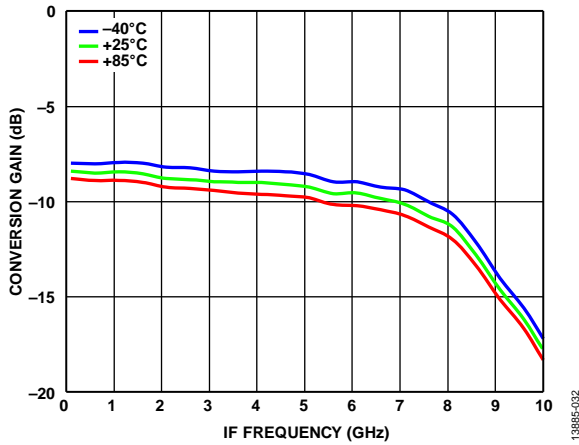

Figure 31. Conversion Gain vs. IF Frequency at Various Temperatures, LO = 13 dBm

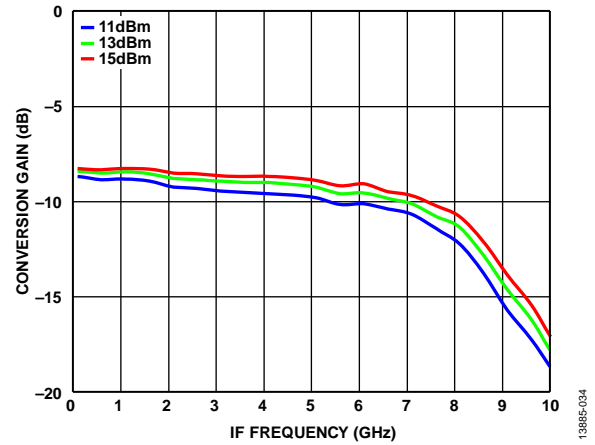

Figure 33. Conversion Gain vs. IF Frequency at Various LO Power Levels,  $T_A = 25^\circ\text{C}$

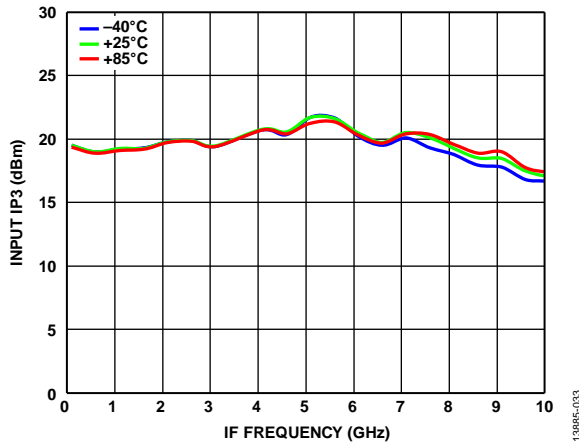

Figure 32. Input IP3 vs. IF Frequency at Various Temperatures, LO = 13 dBm

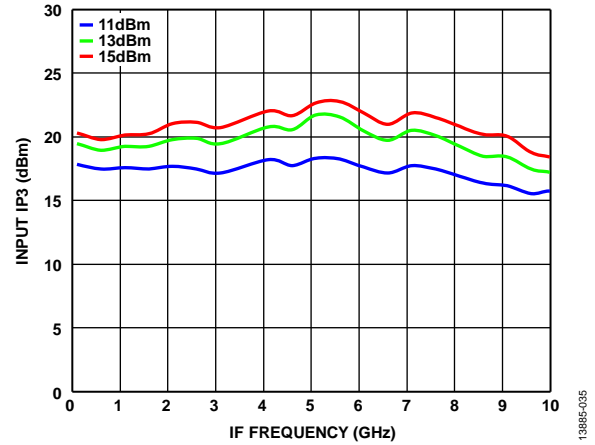

Figure 34. Input IP3 vs. IF Frequency at Various LO Power Levels,  $T_A = 25^\circ\text{C}$

**SPURIOUS AND HARMONICS PERFORMANCE**

Mixer spurious products are measured in dBc from the RF output power level. N/A means not applicable.

**Downconverter, Upper Sideband**

Spur values are  $(M \times RF) - (N \times LO)$ .  $IF_{IN} = 1$  GHz, LO = 21 GHz, RF power = -10 dBm, and LO power = +13 dBm.

		N × LO				
		0	1	2	3	4
M × RF	0	N/A	3	28	N/A	N/A
	1	24	0	43	68	N/A
	2	71	64	64	69	73
	3	N/A	73	81	74	86
	4	N/A	N/A	73	80	85

**Upconverter, Upper Sideband**

Spur values are  $(M \times IF_{IN}) + (N \times LO)$ .  $IF_{IN} = 1$  GHz, LO = 21 GHz, RF power = -10 dBm, and LO power = +13 dBm.

		N × LO				
		0	1	2	3	4
M × IF <sub>IN</sub>	-4	86	89	73	N/A	N/A
	-3	89	70	76	N/A	N/A
	-2	64	45	61	N/A	N/A
	-1	24	0	44	N/A	N/A
	0	N/A	18	12	N/A	N/A
	+1	24	0	39	N/A	N/A
	+2	64	44	63	N/A	N/A
	+3	88	76	74	N/A	N/A
	+4	88	84	74	N/A	N/A

## **THEORY OF OPERATION**

The HMC292A is a general-purpose, double balanced mixer that can be used as an upconverter or a downconverter from 14 GHz to 32 GHz.

When used as a downconverter, the HMC292A down converts RF between 14 GHz and 32 GHz to IF between dc and 8 GHz.

When used as an upconverter, the mixer up converts IF between dc and 8 GHz to RF between 14 GHz and 30 GHz.

### APPLICATIONS INFORMATION

Figure 35 shows the typical application circuit for the HMC292A. The HMC292A is a passive device and does not require any external components. The LO and RF pins are internally ac-coupled. The IF pin is internally dc-coupled. Use an external series capacitor when IF operation is not required.

Choose a value that stays within the necessary IF frequency range.

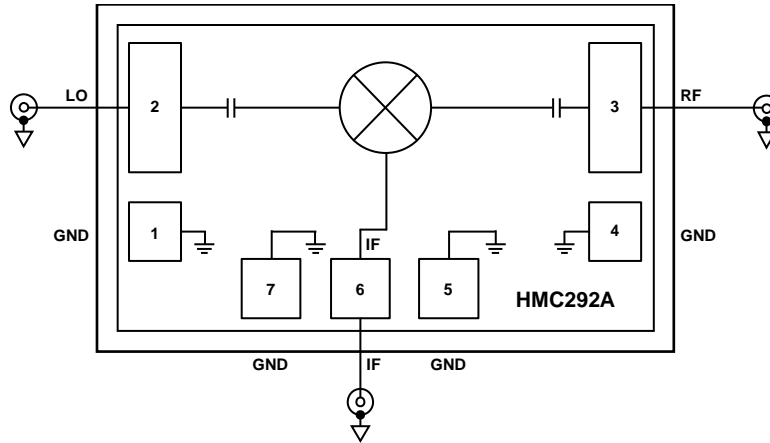

Figure 35. Typical Applications Circuit

13885-039

### ASSEMBLY DIAGRAM

Figure 36 shows the assembly diagram.

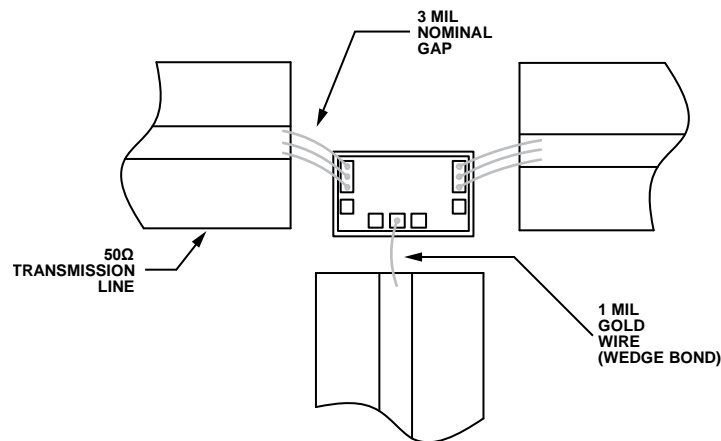

Figure 36. Assembly Diagram

13885-037

## MOUNTING AND BONDING TECHNIQUES FOR MILLIMETER WAVE GaAs MMICs

Attach the die directly to the ground plane eutectically or with conductive epoxy.

To bring RF to and from the chip use 50  $\Omega$  microstrip transmission lines on 0.127 mm (0.005 inches) thick alumina thin film substrates (see Figure 37).

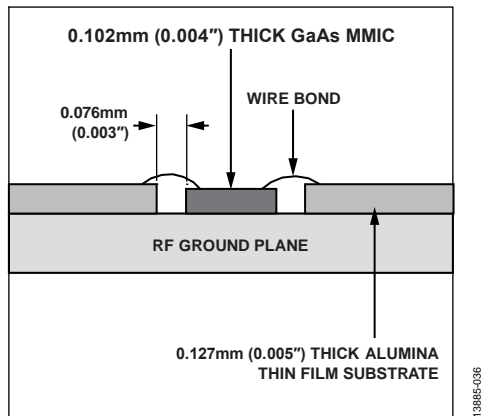

Figure 37. Routing RF Signals

If 0.254 mm (0.010 inches) thick alumina thin film substrates must be used, raise the die 0.150 mm (0.006 inches) so that the surface of the die is coplanar with the surface of the substrate. One way to accomplish this is to attach the 0.102 mm (0.004 inches) thick die to a 0.150 mm (0.006 inches) thick molybdenum heat spreader (moly-tab) that is then attached to the ground plane (see Figure 38).

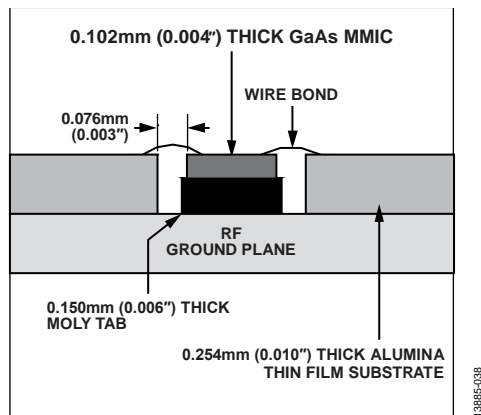

Figure 38. Routing RF Signals (Raised)

Microstrip substrates must be brought as close to the die as possible to minimize ribbon bond length. Typical die to substrate spacing is 0.076 mm to 0.152 mm (0.003 inches to 0.006 inches). Gold ribbon of 0.076 mm (0.003 inches) width and minimal length <0.31 mm (<0.012 inches) is recommended to minimize inductance on RF, LO, and IF ports.

### HANDLING PRECAUTIONS

To avoid permanent damage, adhere to the following precautions.

### Storage

All bare die ship in either waffle or gel-based ESD protective containers and are then sealed in an ESD protective bag. After opening the sealed ESD protective bag, all die must be stored in a dry nitrogen environment.

### Cleanliness

Handle the chips in a clean environment. Never use liquid cleaning systems to clean the chip.

### Static Sensitivity

Follow ESD precautions to protect against ESD strikes.

### Transients

Suppress instrument and bias supply transients while bias is applied. To minimize inductive pickup, use shielded signal and bias cables.

### General Handling

Handle the chip on the edges only using a vacuum collet or with a sharp pair of bent tweezers. Because the surface of the chip has fragile air bridges, never touch the surface of the chip with a vacuum collet, tweezers, or fingers.

### MOUNTING

The chip is back metallized and can be die mounted with gold/tin (AuSn) eutectic preforms or with electrically conductive epoxy. The mounting surface must be clean and flat.

### Eutectic Die Attach

It is best to use an 80% Au/20% Sn preform with a work surface temperature of 255°C and a tool temperature of 265°C. When hot 90% nitrogen/10% hydrogen gas is applied, maintain a tool tip temperature at 290°C. Do not expose the chip to a temperature greater than 320°C for more than 20 sec. No more than 3 sec of scrubbing is required for attachment.

### Epoxy Die Attach

Apply a minimum amount of epoxy to the mounting surface so that a thin epoxy fillet is observed around the perimeter of the chip after placing it into position. Cure the epoxy per schedule provided by the manufacturer.

### WIRE BONDING

RF bonds made with 0.003 inches  $\times$  0.0005 inches gold ribbon are recommended for the RF ports. These bonds must be thermosonically bonded with a force of 40 g to 60 g. DC bonds of 0.025 mm (0.001 inches) diameter, thermosonically bonded, are recommended. Create ball bonds with a force of 40 g to 50 g and wedge bonds with a force of 18 g to 22 g. Create all bonds with a nominal stage temperature of 150°C. Apply a minimum amount of ultrasonic energy to achieve reliable bonds. Keep all bonds as short as possible, <0.31 mm (<0.012 inches).



# OUTLINE DIMENSIONS

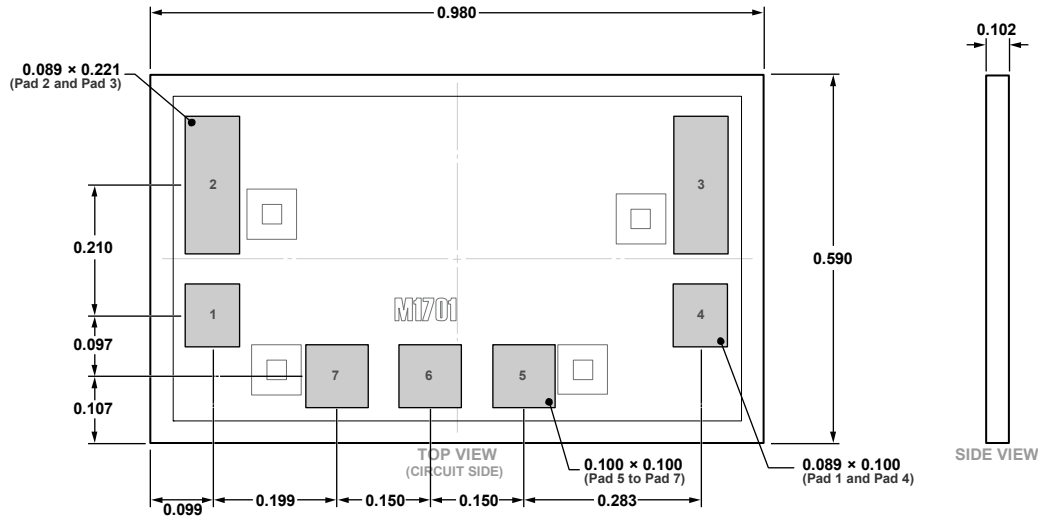

Figure 39. 7-Pad Bare Die [CHIP]  
(C-7-4)  
Dimensions shown in millimeters

## ORDERING GUIDE

Model <sup>1,2</sup>	Temperature Range	Package Description	Package Option
HMC292A	-55°C to +85°C	7-Pad Bare Die [CHIP]	C-7-4
HMC292A-SX	-55°C to +85°C	7-Pad Bare Die [CHIP]	C-7-4

<sup>1</sup> The HMC292A is a RoHS Compliant Part.  
<sup>2</sup> The HMC292A consists of a pair of die in a gel pack for sample orders.