

## GaAs MMIC HERMETIC SMT SPDT SWITCH, DC - 8 GHz

### Typical Applications

The HMC347G8 is ideal for:

- Telecom Infrastructure
- Microwave Radio & VSAT
- Military Radios, Radar & ECM
- Test Instrumentation

### Features

- Isolation: 42 dB @ 2.5 GHz  
30 dB @ 6 GHz
- Insertion Loss: 2 dB @ 6 GHz
- Non-Reflective Design
- 8 Lead Hermetic SMT Package

### Functional Diagram

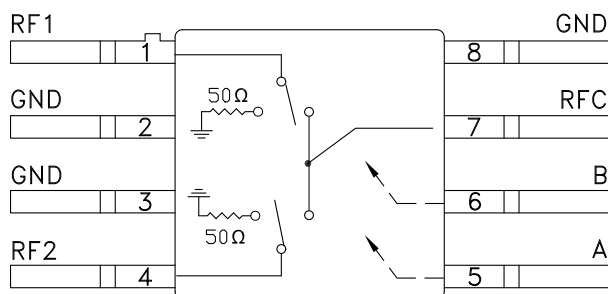

### General Description

The HMC347G8 is a broadband high isolation non-reflective GaAs MESFET SPDT switch in a 8 lead glass/metal (hermetic) surface mount package. Covering DC to 8 GHz, the switch features >42 dB isolation up to 2 GHz and >25 dB isolation up to 8 GHz. The switch operates using complementary negative control voltage logic lines of -5/0V and requires no bias supply. This SPDT is a good replacement for the HMC132G7 SPDT.

### Electrical Specifications, $T_A = +25^\circ\text{C}$ , With 0/-5V Control, 50 Ohm System

Parameter	Frequency	Min.	Typ.	Max.	Units
Insertion Loss	DC - 2.0 GHz		2.0	2.3	dB
	DC - 6.0 GHz		2.2	2.6	dB
	DC - 8.0 GHz		2.2	2.7	dB
Isolation	DC - 2.0 GHz	39	43		dB
	DC - 6.0 GHz	25	28		dB
	DC - 8.0 GHz	22	25		dB
Return Loss	DC - 2.0 GHz	9	12		dB
	DC - 8.0 GHz	6	10		dB
Return Loss RF1, RF2	DC - 2.0 GHz		9		dB
	DC - 8.0 GHz		6		dB
Input Power for 1 dB Compression	0.5 - 8.0 GHz	19	23		dBm
Input Third Order Intercept (Two-Tone Input Power= +7 dBm Each Tone, 1 MHz Tone Separation)	0.5 - 8.0 GHz	38	43		dBm
Switching Characteristics	DC - 8.0 GHz	tRISE, tFALL (10/90% RF)	3		ns
		tON, tOFF (50% CTL to 10/90% RF)	6		ns

Information furnished by Analog Devices is believed to be accurate and reliable. However, no responsibility is assumed by Analog Devices for its use, nor for any infringements of patents or other rights of third parties that may result from its use. Specifications subject to change without notice. No license is granted by implication or otherwise under any patent or patent rights of Analog Devices. Trademarks and registered trademarks are the property of their respective owners.

For price, delivery, and to place orders: Analog Devices, Inc., One Technology Way, P.O. Box 9106, Norwood, MA 02062-9106  
Phone: 781-329-4700 • Order online at [www.analog.com](http://www.analog.com)  
Application Support: Phone: 1-800-ANALOG-D

**GaAs MMIC HERMETIC SMT SPDT  
SWITCH, DC - 8 GHz**

**Insertion Loss**

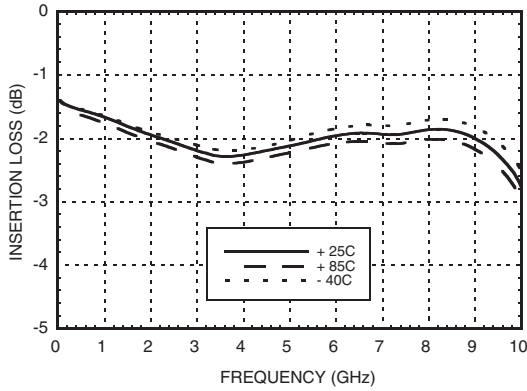

**Isolation**

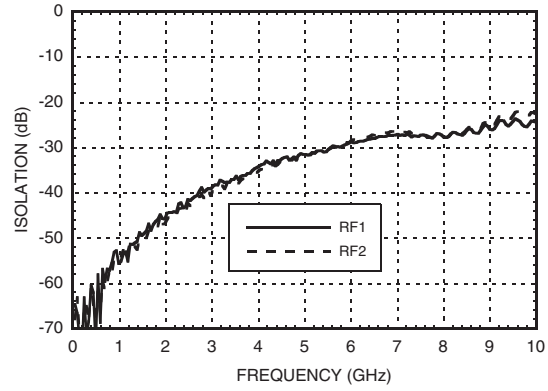

**Return Loss**

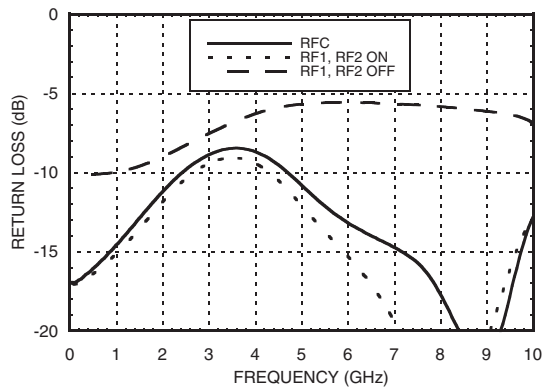

**0.1 and 1 dB Input Compression Point**

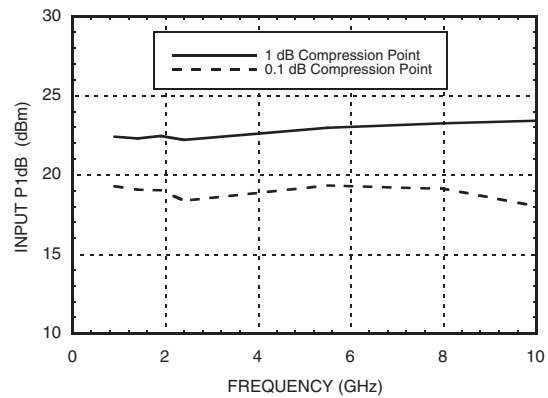

**Input Third Order Intercept Point**

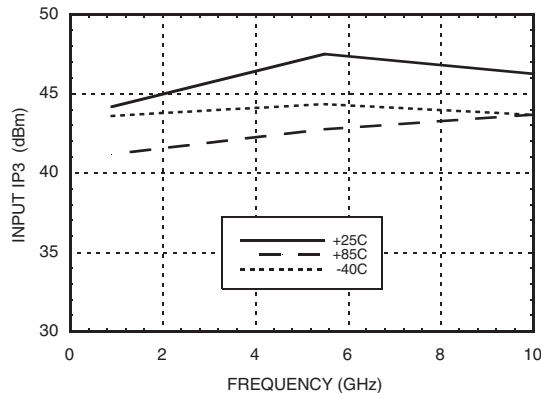

Information furnished by Analog Devices is believed to be accurate and reliable. However, no responsibility is assumed by Analog Devices for its use, nor for any infringements of patents or other rights of third parties that may result from its use. Specifications subject to change without notice. No license is granted by implication or otherwise under any patent or patent rights of Analog Devices. Trademarks and registered trademarks are the property of their respective owners.

For price, delivery, and to place orders: Analog Devices, Inc., One Technology Way, P.O. Box 9106, Norwood, MA 02062-9106 Phone: 781-329-4700 • Order online at [www.analog.com](http://www.analog.com) Application Support: Phone: 1-800-ANALOG-D

## GaAs MMIC HERMETIC SMT SPDT SWITCH, DC - 8 GHz

### Absolute Maximum Ratings

RF Input Power (Vctl = -5V)	+27 dBm
Control Voltage Range (A & B)	+0.5V to -7.5 Vdc
Channel Temperature	150 °C
Thermal Resistance (Insertion Loss Path)	440 °C/W
Thermal Resistance (Terminated Path)	540 °C/W
Storage Temperature	-65 to +150 °C
Operating Temperature	-55 to +85 °C
ESD Sensitivity (HBM)	Class 1A

### Control Voltages

State	Bias Condition
Low	0 to -0.2V @ 10 uA Max.
High	-5V @ 10 uA Typ. to -7V @ 40 uA Typ. (± 0.5 Vdc)

### Truth Table

Control Input		Signal Path State	
A	B	RFC to RF1	RFC to RF2
High	Low	On	Off
Low	High	Off	On

Caution: Do not "Hot Switch" power levels greater than +13 dBm (Vctl = 0/-5 Vdc).



**ELECTROSTATIC SENSITIVE DEVICE  
OBSERVE HANDLING PRECAUTIONS**

10

SWITCHES - SMT

### Outline Drawing

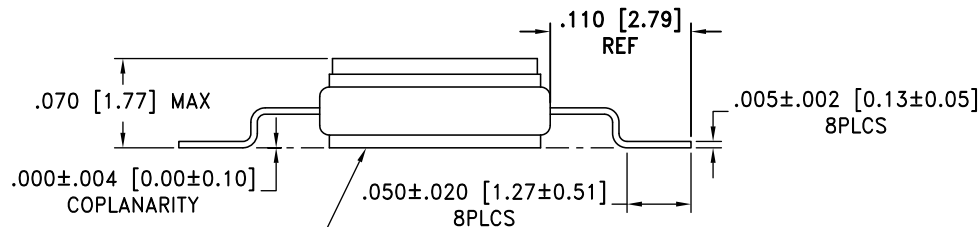
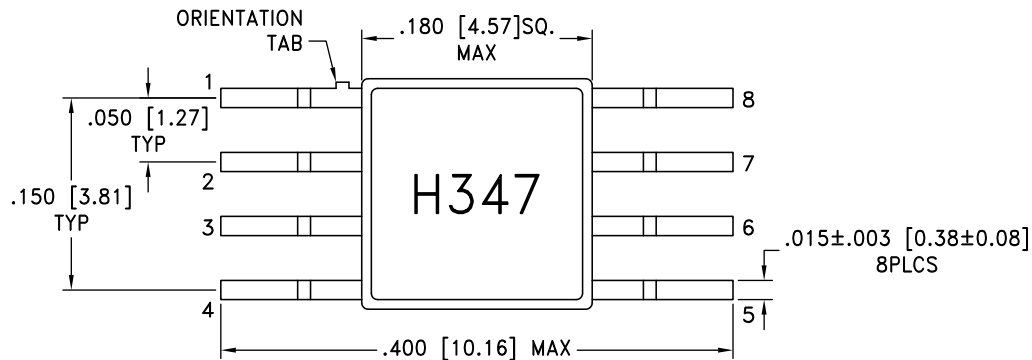

**NOTES:**

1. PACKAGE MATERIAL: ALUMINA LOADED BOROSILICATE GLASS.
2. LEAD, BASE, COVER MATERIAL: KOVAR™ (#7052 CORNING).
3. PLATING: ELECTROLYTIC GOLD 50 MICROINCHES MIN., OVER ELECTROLYTIC NICKEL 50 MICROINCHES MIN.
4. DIMENSIONS ARE IN INCHES [MILLIMETERS].
5. TOLERANCES: ±.005 [0.13] UNLESS OTHERWISE SPECIFIED.
6. ALL GROUND LEADS AND GROUND PADDLE MUST BE SOLDERED TO PCB RF GROUND.

## GaAs MMIC HERMETIC SMT SPDT SWITCH, DC - 8 GHz

### Suggested Driver Circuit

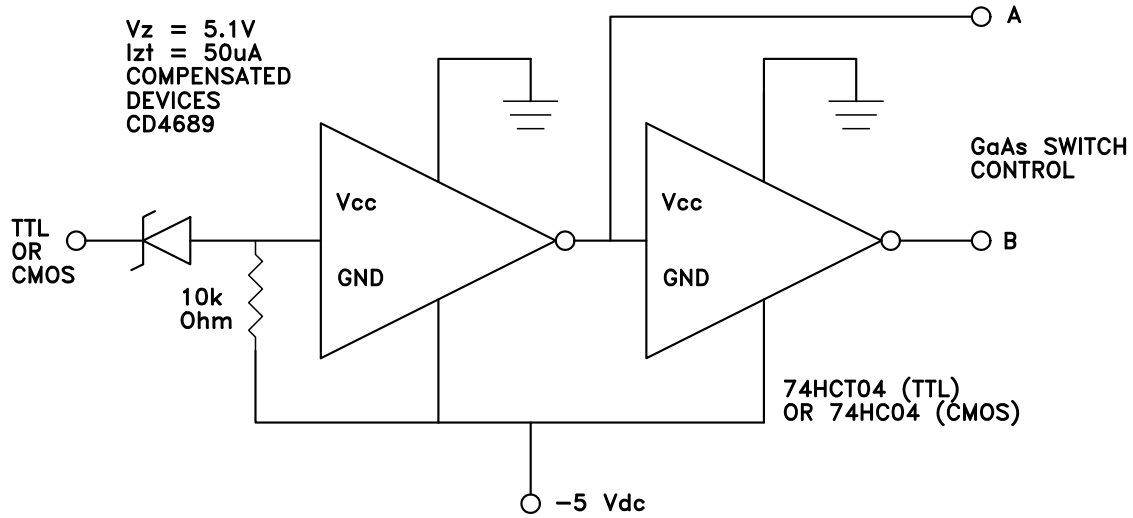

### Pin Descriptions

Pin Number	Function	Description	Interface Schematic
1, 4, 7	RFC, RF1, RF2	This pin is DC coupled and matched to 50 Ohm. Blocking capacitors are required if RF line potential is not equal to 0V.	
2, 3, 8	GND	Package bottom must also be connected to PCB RF ground.	
5	CTLA	See truth table and control voltage table.	
6	CTLB	See truth table and control voltage table.	

Information furnished by Analog Devices is believed to be accurate and reliable. However, no responsibility is assumed by Analog Devices for its use, nor for any infringements of patents or other rights of third parties that may result from its use. Specifications subject to change without notice. No license is granted by implication or otherwise under any patent or patent rights of Analog Devices. Trademarks and registered trademarks are the property of their respective owners.

For price, delivery, and to place orders: Analog Devices, Inc., One Technology Way, P.O. Box 9106, Norwood, MA 02062-9106 Phone: 781-329-4700 • Order online at [www.analog.com](http://www.analog.com) Application Support: Phone: 1-800-ANALOG-D

**GaAs MMIC HERMETIC SMT SPDT  
SWITCH, DC - 8 GHz**

**Evaluation PCB**

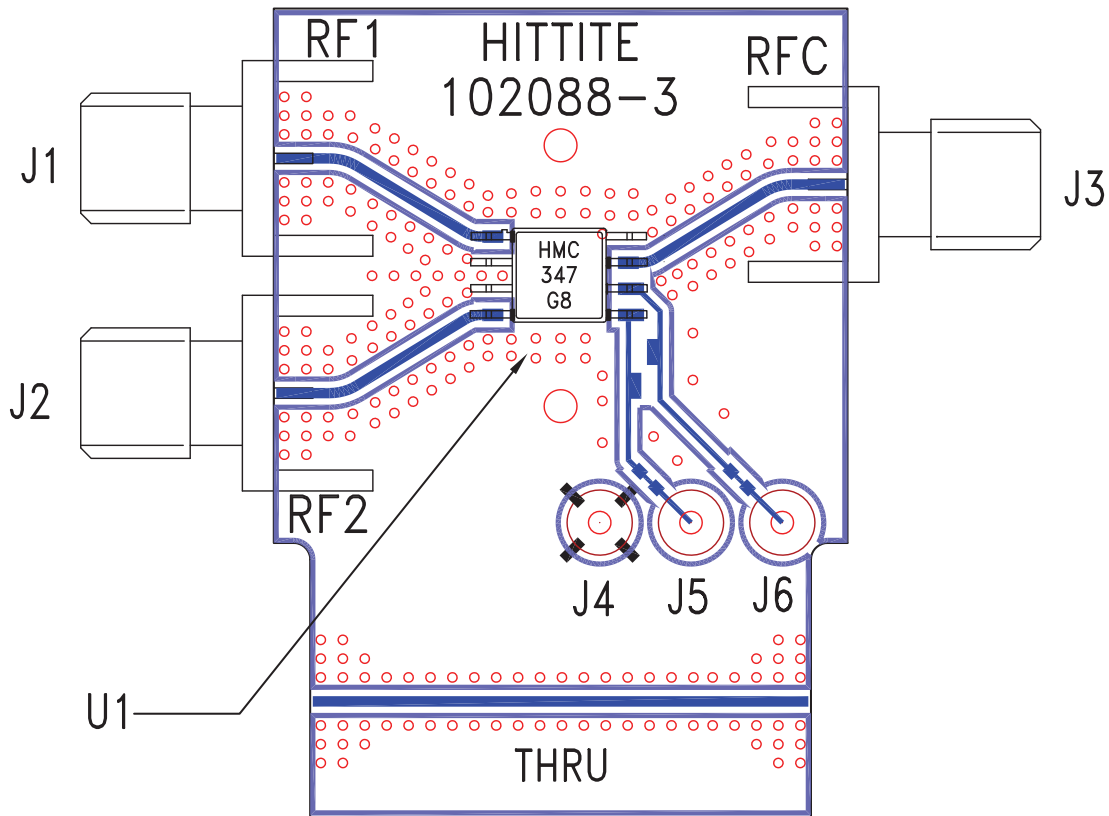

10

SWITCHES - SMT

**List of Materials for Evaluation PCB 107261 [1]**

Item	Description
J1 - J3	PCB Mount SMA RF Connector
J4 - J6	DC Pin
U1	HMC347G8 SPDT Switch
PCB [2]	102088-3 Evaluation PCB

[1] Reference this number when ordering complete evaluation PCB

[2] Circuit Board Material: Rogers 4350

The circuit board used in the final application should be generated with proper RF circuit design techniques. Signal lines at the RF port should have 50 ohm impedance and the package ground leads and package bottom should be connected directly to the ground plane similar to that shown above. The evaluation circuit board shown above is available from Hittite Microwave Corporation upon request.



# HMC347G8

v02.0605

## GaAs MMIC HERMETIC SMT SPDT SWITCH, DC - 8 GHz

### Notes:

10

SWITCHES - SMT

Information furnished by Analog Devices is believed to be accurate and reliable. However, no responsibility is assumed by Analog Devices for its use, nor for any infringements of patents or other rights of third parties that may result from its use. Specifications subject to change without notice. No license is granted by implication or otherwise under any patent or patent rights of Analog Devices. Trademarks and registered trademarks are the property of their respective owners.

For price, delivery, and to place orders: Analog Devices, Inc., One Technology Way, P.O. Box 9106, Norwood, MA 02062-9106  
Phone: 781-329-4700 • Order online at [www.analog.com](http://www.analog.com)  
Application Support: Phone: 1-800-ANALOG-D