



## GaAs pHEMT MMIC MEDIUM POWER AMPLIFIER, 6.5 - 13.5 GHz

### Typical Applications

The HMC441LP3 / HMC441LP3E is a medium PA for:

- Point-to-Point Radios
- Point-to-Multi-Point Radios
- VSAT
- LO Driver for HMC Mixers
- Military EW & ECM

### Features

- Gain: 14 dB
- Saturated Power: +20 dBm @ 20% PAE
- Single Supply Voltage: +5V w/ Optional Gate Bias
- 50 Ohm Matched Input/Output
- 16 Lead 3x3mm SMT Package: 9mm<sup>2</sup>

### Functional Diagram

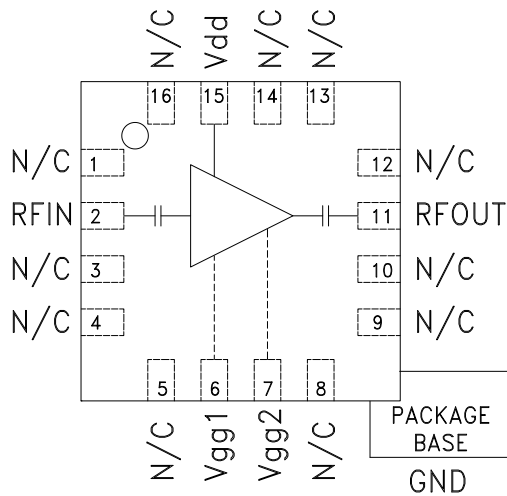

TOP VIEW

Vgg1, Vgg2: Optional Gate Bias

### General Description

The HMC441LP3 & HMC441LP3E are broadband GaAs PHEMT MMIC Medium Power Amplifiers which operate between 6.5 and 13.5 GHz. The leadless plastic QFN surface mount packaged amplifier provides 14 dB of gain, +20 dBm saturated power at 20% PAE from a +5V supply voltage. An optional gate bias is provided to allow adjustment of gain, RF output power, and DC power dissipation. This 50 Ohm matched amplifier does not require any external components making it an ideal linear gain block or driver for HMC SMT mixers.

### Electrical Specifications, $T_A = +25^\circ C$ , $V_{dd} = 5V$ , $V_{gg1} = V_{gg2} = Open$

Parameter	Min.	Typ.	Max.	Min.	Typ.	Max.	Min.	Typ.	Max.	Units
Frequency Range	6.5 - 8.0			8.0 - 11.0			11.0 - 13.5			GHz
Gain	10	13		12	14		10	13		dB
Gain Variation Over Temperature		0.02	0.025		0.02	0.025		0.02	0.025	dB/°C
Input Return Loss		12			15			14		dB
Output Return Loss		12			15			13		dB
Output Power for 1 dB Compression (P1dB)	13	16		15	18		14	17		dBm
Saturated Output Power (P <sub>sat</sub> )		18.5			20			19.5		dBm
Output Third Order Intercept (IP3)	23	26		26	29		26	29		dBm
Noise Figure		5.0			4.5			4.75		dB
Supply Current (I <sub>dd</sub> )		90	115		90	115		90	115	mA

Information furnished by Analog Devices is believed to be accurate and reliable. However, no responsibility is assumed by Analog Devices for its use, nor for any infringements of patents or other rights of third parties that may result from its use. Specifications subject to change without notice. No license is granted by implication or otherwise under any patent or patent rights of Analog Devices. Trademarks and registered trademarks are the property of their respective owners.

For price, delivery, and to place orders: Analog Devices, Inc., One Technology Way, P.O. Box 9106, Norwood, MA 02062-9106  
 Phone: 781-329-4700 • Order online at [www.analog.com](http://www.analog.com)  
 Application Support: Phone: 1-800-ANALOG-D

# HMC441LP3\* PRODUCT PAGE QUICK LINKS

Last Content Update: 02/23/2017

---

## COMPARABLE PARTS

View a parametric search of comparable parts.

## EVALUATION KITS

- HMC441LP3 Evaluation Board

## DOCUMENTATION

### Application Notes

- AN-1363: Meeting Biasing Requirements of Externally Biased RF/Microwave Amplifiers with Active Bias Controllers
- Broadband Biasing of Amplifiers General Application Note
- MMIC Amplifier Biasing Procedure Application Note
- Thermal Management for Surface Mount Components General Application Note

### Data Sheet

- HMC441LP3 Data Sheet

## TOOLS AND SIMULATIONS

- HMC441LP3 S-Parameters

## REFERENCE MATERIALS

### Quality Documentation

- Package/Assembly Qualification Test Report: LP2, LP2C, LP3, LP3B, LP3C, LP3D, LP3F, LP3G (QTR: 2014-0364)
- Semiconductor Qualification Test Report: PHEMT-F (QTR: 2013-00269)

## DESIGN RESOURCES

- HMC441LP3 Material Declaration
- PCN-PDN Information
- Quality And Reliability
- Symbols and Footprints

## DISCUSSIONS

View all HMC441LP3 EngineerZone Discussions.

## SAMPLE AND BUY

Visit the product page to see pricing options.

## TECHNICAL SUPPORT

Submit a technical question or find your regional support number.

## DOCUMENT FEEDBACK

Submit feedback for this data sheet.

---



**GaAs pHEMT MMIC MEDIUM POWER AMPLIFIER, 6.5 - 13.5 GHz**

**Broadband Gain & Return Loss**

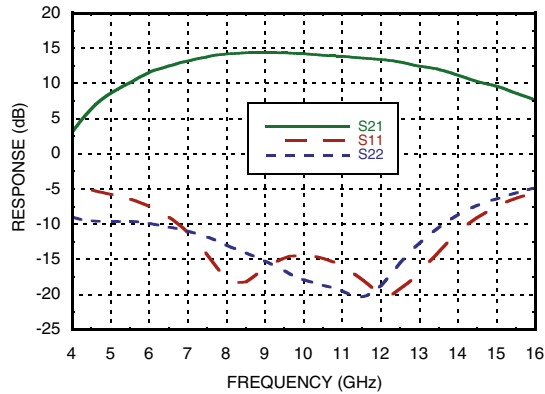

**Gain vs. Temperature**

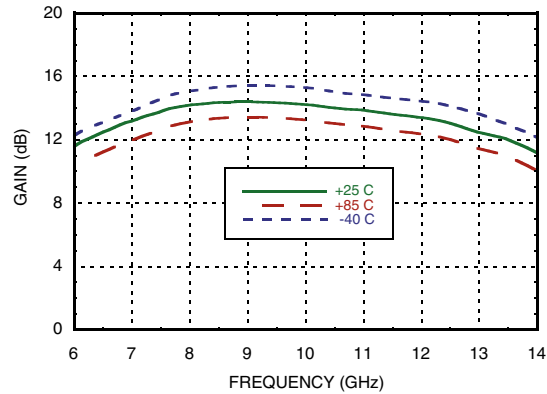

**Input Return Loss vs. Temperature**

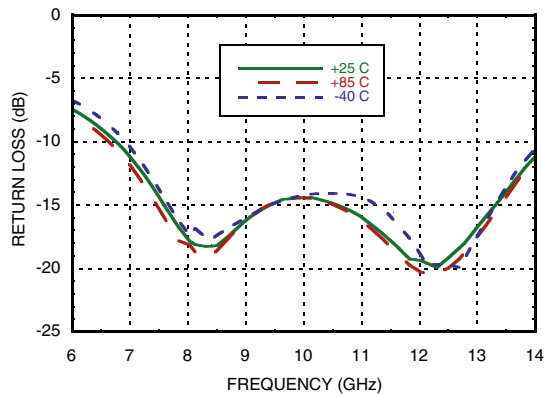

**Output Return Loss vs. Temperature**

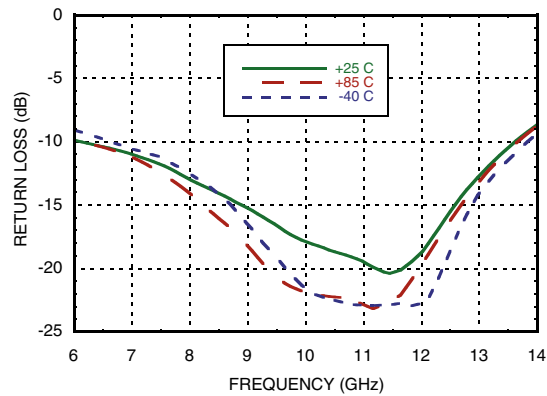

**P1dB vs. Temperature**

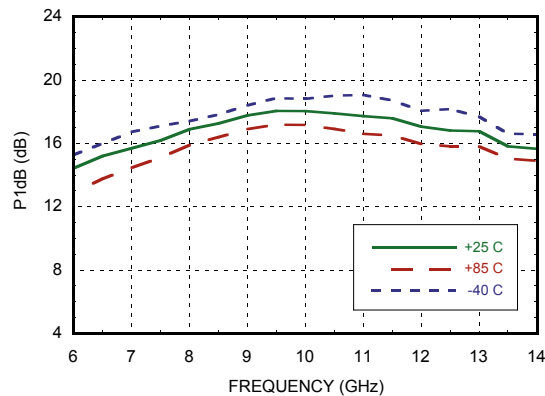

**Psat vs. Temperature**

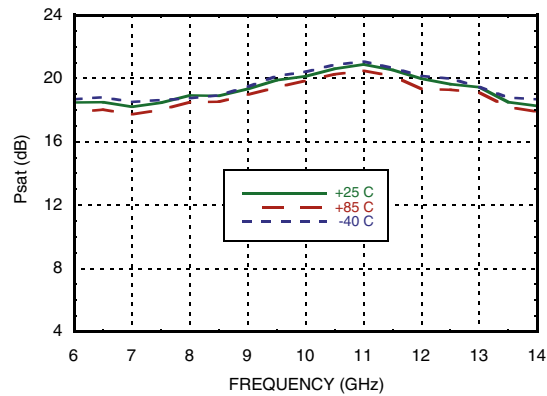

Information furnished by Analog Devices is believed to be accurate and reliable. However, no responsibility is assumed by Analog Devices for its use, nor for any infringements of patents or other rights of third parties that may result from its use. Specifications subject to change without notice. No license is granted by implication or otherwise under any patent or patent rights of Analog Devices. Trademarks and registered trademarks are the property of their respective owners.

For price, delivery, and to place orders: Analog Devices, Inc., One Technology Way, P.O. Box 9106, Norwood, MA 02062-9106 Phone: 781-329-4700 • Order online at [www.analog.com](http://www.analog.com) Application Support: Phone: 1-800-ANALOG-D



**Power Compression @ 10 GHz**

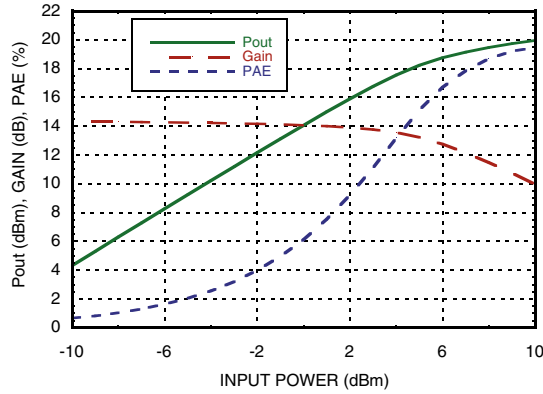

**Output IP3 vs. Temperature**

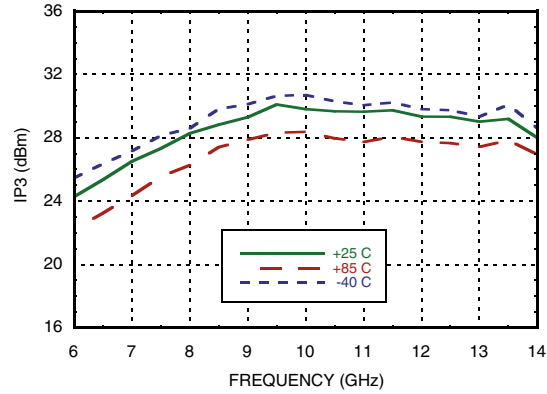

**Gain, Power & Output IP3 vs. Supply Voltage @ 10 GHz**

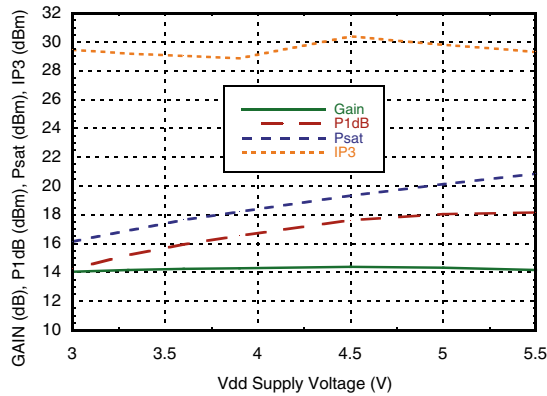

**Gain, Power & Idd vs. Gate Voltage @ 10 GHz**

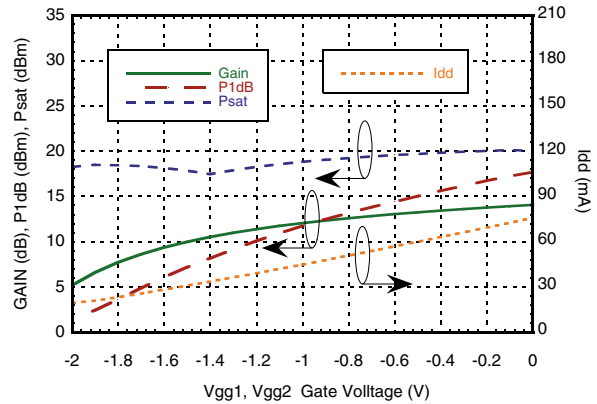

**Noise Figure vs. Temperature**

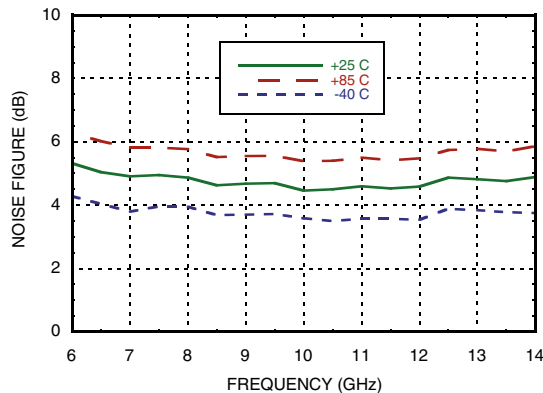

**Reverse Isolation vs. Temperature**

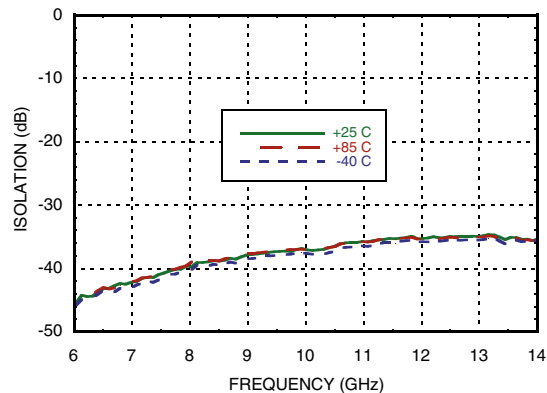

Information furnished by Analog Devices is believed to be accurate and reliable. However, no responsibility is assumed by Analog Devices for its use, nor for any infringements of patents or other rights of third parties that may result from its use. Specifications subject to change without notice. No license is granted by implication or otherwise under any patent or patent rights of Analog Devices. Trademarks and registered trademarks are the property of their respective owners.

For price, delivery, and to place orders: Analog Devices, Inc., One Technology Way, P.O. Box 9106, Norwood, MA 02062-9106 Phone: 781-329-4700 • Order online at [www.analog.com](http://www.analog.com) Application Support: Phone: 1-800-ANALOG-D



## GaAs pHEMT MMIC MEDIUM POWER AMPLIFIER, 6.5 - 13.5 GHz

### Absolute Maximum Ratings

Drain Bias Voltage (Vdd)	+6 Vdc
Gate Bias Voltage (Vgg1,Vgg2)	-8 to 0 Vdc
RF Input Power (RFIN)(Vdd = +5 Vdc)	+15 dBm
Channel Temperature	175 °C
Continuous Pdiss (T = 85 °C) (derate 8.5 mW/°C above 85 °C)	0.76 W
Thermal Resistance (channel to ground paddle)	118.2 °C/W
Storage Temperature	-65 to +150 °C
Operating Temperature	-40 to +85 °C

### Typical Supply Current vs. Vdd

Vdd (V)	Idd (mA)
+5.5	92
+5.0	90
+4.5	88
+3.3	83
+3.0	82

Note: Amplifier will operate over full voltage range shown above



ELECTROSTATIC SENSITIVE DEVICE  
OBSERVE HANDLING PRECAUTIONS

### Outline Drawing

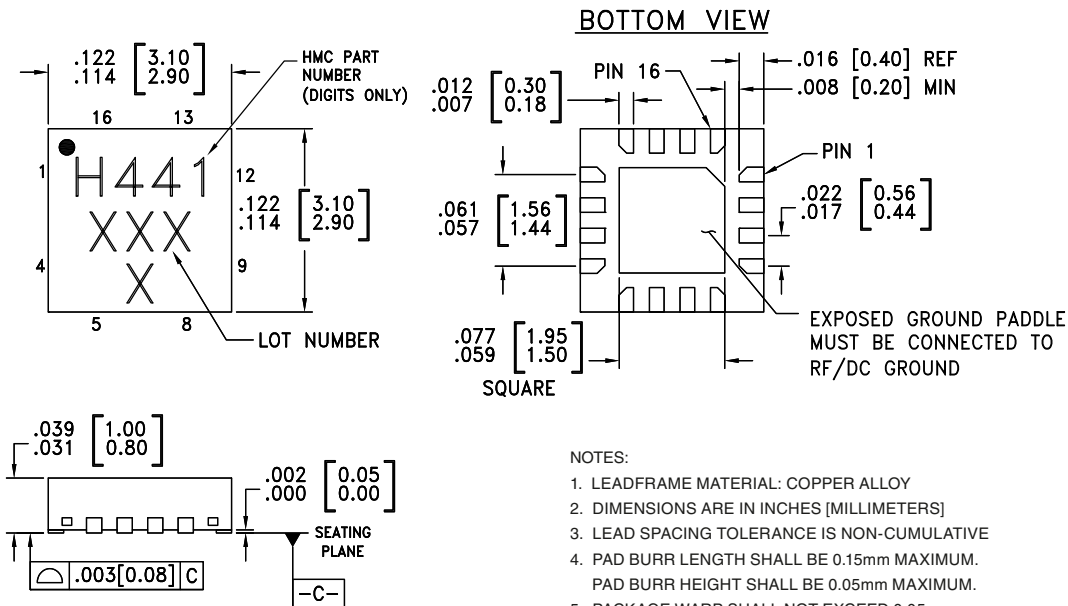

NOTES:

- LEADFRAME MATERIAL: COPPER ALLOY
- DIMENSIONS ARE IN INCHES [MILLIMETERS]
- LEAD SPACING TOLERANCE IS NON-CUMULATIVE
- PAD BURR LENGTH SHALL BE 0.15mm MAXIMUM.  
PAD BURR HEIGHT SHALL BE 0.05mm MAXIMUM.
- PACKAGE WARP SHALL NOT EXCEED 0.05mm.
- ALL GROUND LEADS AND GROUND PADDLE MUST BE SOLDERED TO PCB RF GROUND.
- REFER TO HITTITE APPLICATION NOTE FOR SUGGESTED LAND PATTERN.

### Package Information

Part Number	Package Body Material	Lead Finish	MSL Rating	Package Marking <sup>[3]</sup>
HMC441LP3	Low Stress Injection Molded Plastic	Sn/Pb Solder	MSL1 <sup>[1]</sup>	441 XXXX
HMC441LP3E	RoHS-compliant Low Stress Injection Molded Plastic	100% matte Sn	MSL1 <sup>[2]</sup>	441 XXXX

[1] Max peak reflow temperature of 235 °C



[2] Max peak reflow temperature of 260 °C

[3] 4-Digit lot number XXXX

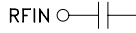
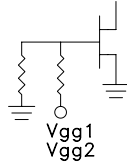
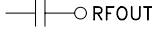
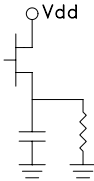

## GaAs pHEMT MMIC MEDIUM POWER AMPLIFIER, 6.5 - 13.5 GHz

### Pin Descriptions

Pin Number	Function	Description	Interface Schematic
1, 3-5, 8-10, 12-14, 16	N/C	This pin may be connected to RF/DC ground.	
2	RFIN	This pin is AC coupled and matched to 50 Ohms.	RFIN 
6, 7	Vgg1, Vgg2	Optional gate control for amplifier. If left open, the amplifier will run at standard current. Negative voltage applied will reduce current.	
11	RFOUT	This pin is AC coupled and matched to 50 Ohms.	
15	Vdd	Power Supply Voltage for the amplifier. An external bypass capacitor of 100 pF is required.	
	GND	Package bottom must be connected to RF/DC ground.	



**GaAs pHEMT MMIC MEDIUM  
POWER AMPLIFIER, 6.5 - 13.5 GHz**

**Evaluation PCB**

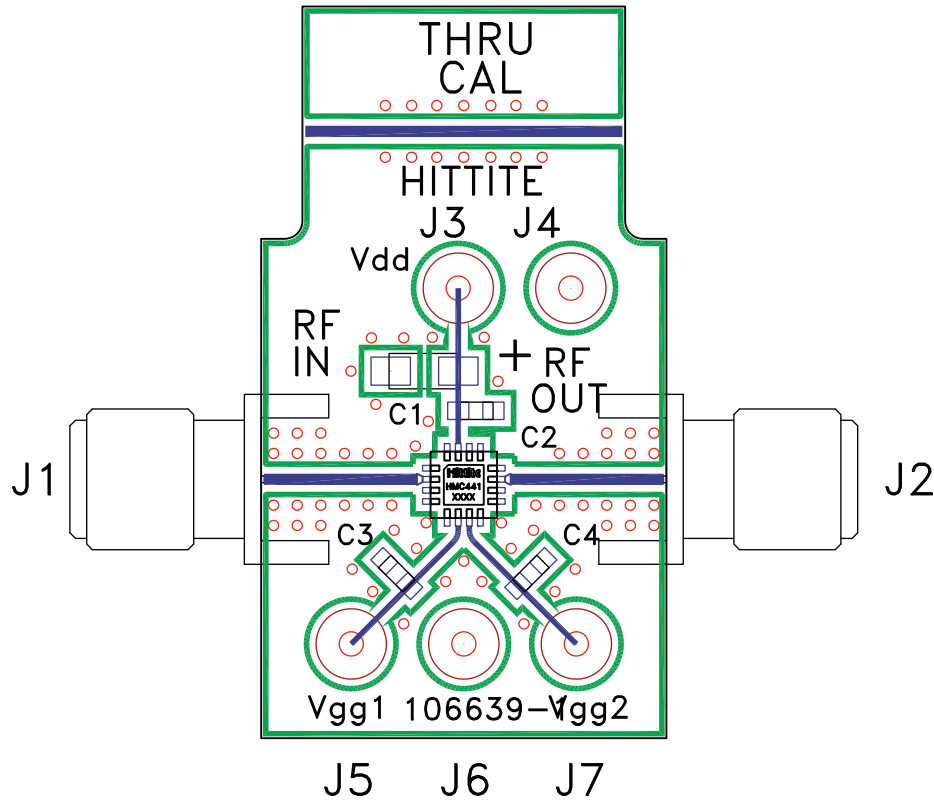

**List of Materials for Evaluation PCB 106705 [1]**

Item	Description
J1 - J2	PCB Mount SMA Connector
J3 - J7	DC Pin
C1	4.7 $\mu$ F Capacitor, Tantalum
C2 - C4	100 pF Capacitor, 0402 Pkg.
U1	HMC441LP3 / HMC441LP3E Amplifier
PCB [2]	106639 Evaluation PCB, 10 mils

[1] Reference this number when ordering complete evaluation PCB

[2] Circuit Board Material: Rogers 4350

The circuit board used in the final application should use RF circuit design techniques. Signal lines should have 50 Ohm impedance while the package ground leads and exposed paddle should be connected directly to the ground plane similar to that shown. A sufficient number of via holes should be used to connect the top and bottom ground planes. The evaluation board should be mounted to an appropriate heat sink. The evaluation circuit board shown is available from Hittite upon request.