

GaAs PHEMT MMIC POWER AMPLIFIER, 2.0 - 20.0 GHz

Typical Applications

The HMC464LP5 wideband driver is ideal for:

- Telecom Infrastructure
- Microwave Radio & VSAT
- Military EW, ECM & C³I
- Test Instrumentation
- Fiber Optics

Features

- +26 dBm P1dB Output Power
- Gain: 14 dB
- +30 dBm Output IP3
- Supply Voltage: +8.0V @ 290 mA
- 50 Ohm Matched Input/Output
- 25 mm² Leadless SMT Package

Functional Diagram

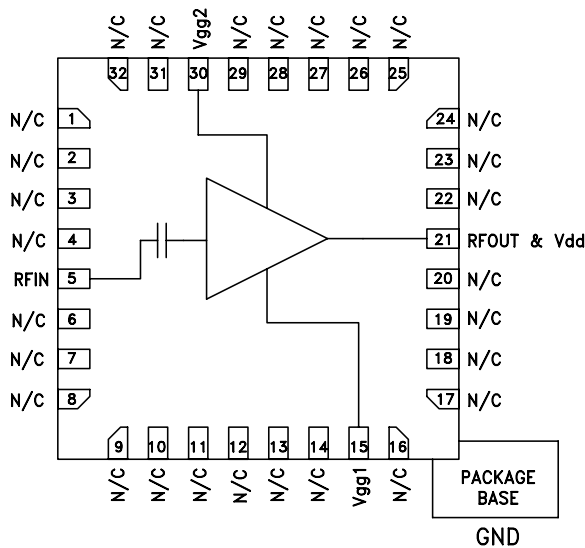

General Description

The HMC464LP5 is a GaAs MMIC PHEMT Distributed Power Amplifier in a leadless 5 x 5 mm surface mount package which operates between 2 and 20 GHz. The amplifier provides 14 dB of gain, +30 dBm output IP3 and +26 dBm of output power at 1 dB gain compression while requiring 290 mA from a +8V supply. Gain flatness is good from 2 - 18 GHz making the HMC464LP5 ideal for EW, ECM and radar driver amplifier as well as test equipment applications. The wideband amplifier I/O's are internally matched to 50 Ohms.

Electrical Specifications, $T_A = +25^\circ C, V_{dd} = 8V, V_{gg2} = 3V, I_{dd} = 290 mA^*$

Parameter	Min.	Typ.	Max.	Min.	Typ.	Max.	Min.	Typ.	Max.	Units
Frequency Range		2.0 - 6.0		6.0 - 16.0			16.0 - 20.0			GHz
Gain	12	14		11.5	13.5		8	11		dB
Gain Flatness		±0.5			±0.5			±1.0		dB
Gain Variation Over Temperature		0.025	0.035		0.03	0.04		0.05	0.06	dB/°C
Input Return Loss		15			10			7		dB
Output Return Loss		15			9			11		dB
Output Power for 1 dB Compression (P1dB)	23.5	26.5		22	25		18	21		dBm
Saturated Output Power (Psat)		27.5			26			24.0		dBm
Output Third Order Intercept (IP3)		32			26			22		dBm
Noise Figure		4.0			4.0			6.0		dB
Supply Current (I _{dd}) (V _{dd} = 8V, V _{gg} = -0.5V Typ.)		290			290			290		mA

* Adjust V_{gg1} between -2 to 0V to achieve I_{dd}= 290 mA typical.

GaAs PHEMT MMIC POWER AMPLIFIER, 2.0 - 20.0 GHz

Gain & Return Loss

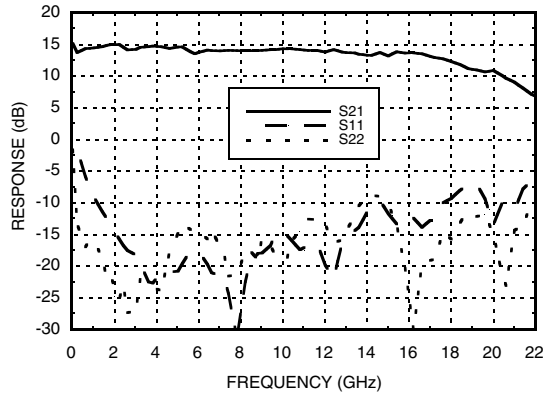

Gain vs. Temperature

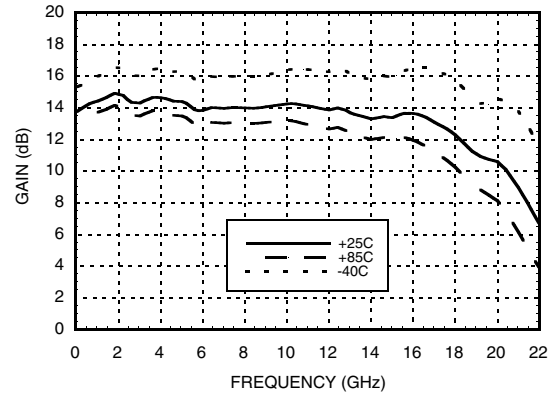

Input Return Loss vs. Temperature

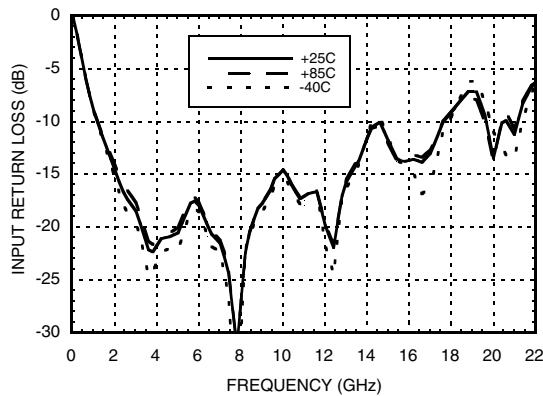

Output Return Loss vs. Temperature

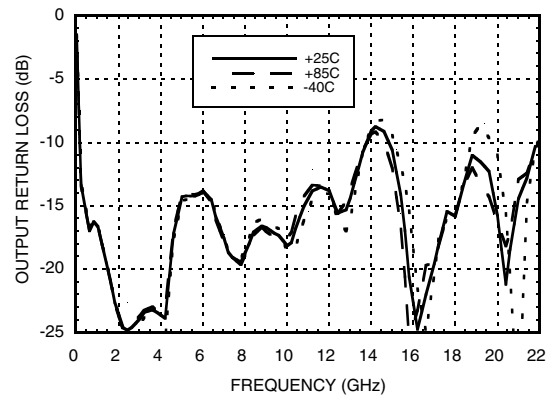

Reverse Isolation vs. Temperature

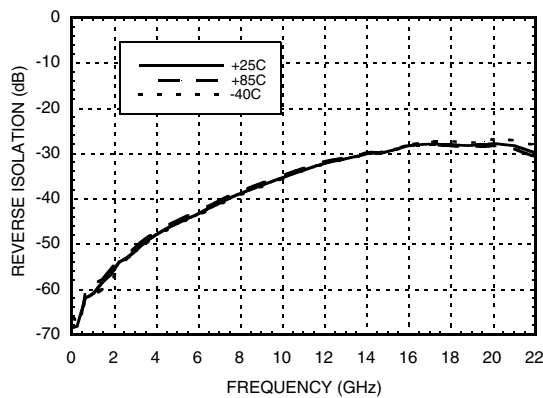

Noise Figure vs. Temperature

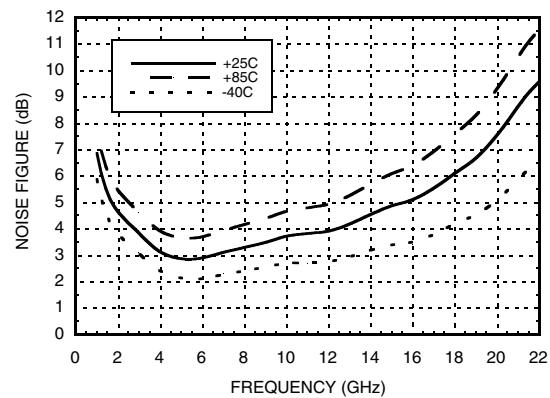

GaAs PHEMT MMIC POWER AMPLIFIER, 2.0 - 20.0 GHz

P1dB vs. Temperature

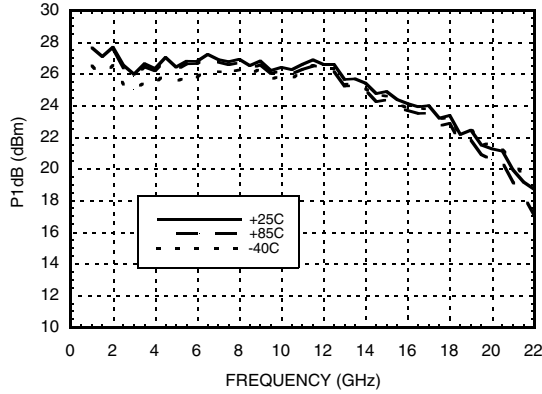

Psat vs. Temperature

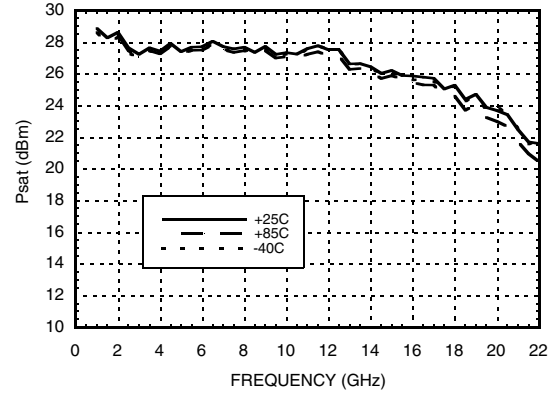

Output IP3 vs. Temperature

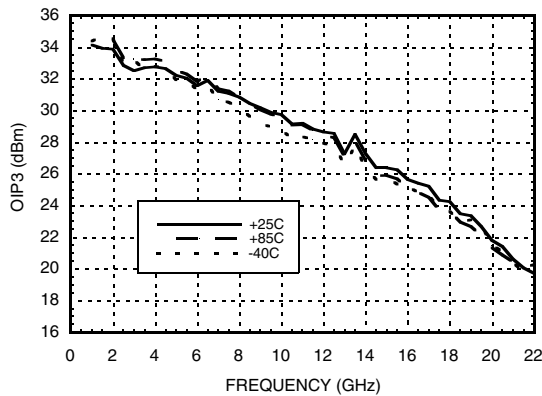

Gain, Power & OIP3 vs. Supply Voltage @ 10 GHz, Fixed Vgg1

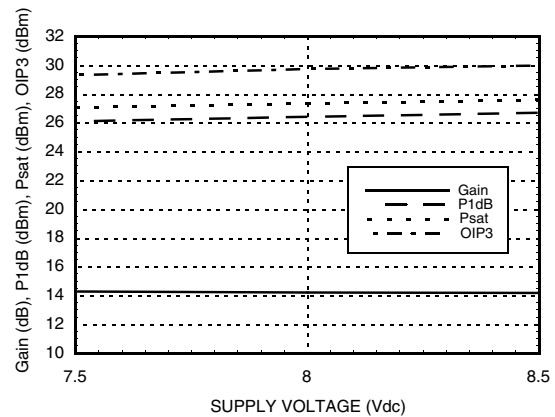

Absolute Maximum Ratings

Drain Bias Voltage (Vdd)	+9.0 Vdc
Gate Bias Voltage (Vgg1)	-2.0 to 0 Vdc
Gate Bias Voltage (Vgg2)	(Vdd - 8.0) Vdc to Vdd
RF Input Power (RFIn)(Vdd = +8.0 Vdc)	+23 dBm
Channel Temperature	150 °C
Continuous Pdiss (T= 85 °C) (derate 51.5 mW/°C above 85 °C)	3.35 W
Thermal Resistance (channel to ground paddle)	19.4 °C/W
Storage Temperature	-65 to +150 °C
Operating Temperature	-40 to +85 °C

Typical Supply Current vs. Vdd

Vdd (V)	Idd (mA)
+7.5	292
+8.0	290
+8.5	288

GaAs PHEMT MMIC POWER AMPLIFIER, 2.0 - 20.0 GHz

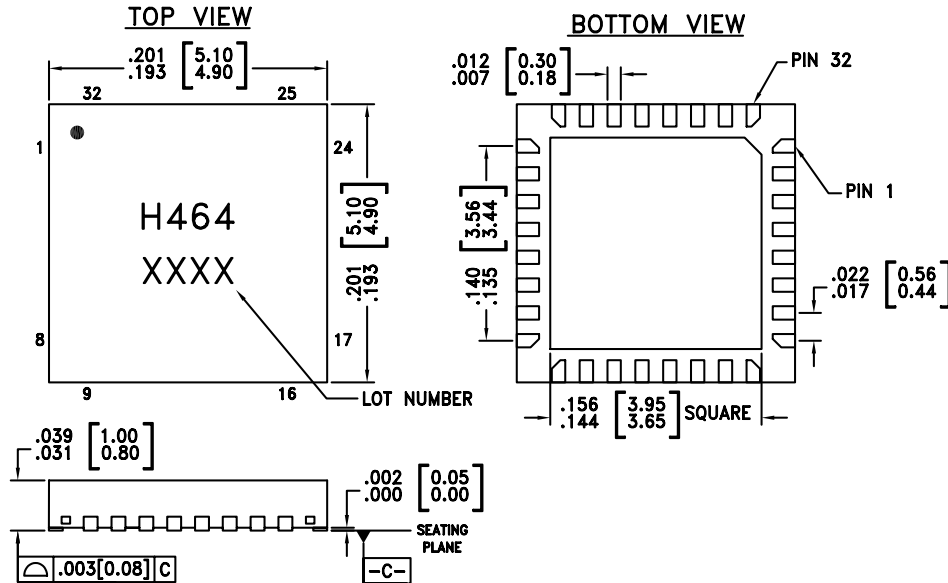

Outline Drawing



NOTES:

1. ALL DIMENSIONS IN INCHES [MILLIMETERS]
2. NO CONNECTION REQUIRED FOR UNLABELED BOND PADS
3. DIE THICKNESS IS 0.004 (0.100)
4. TYPICAL BOND PAD IS 0.004 (0.100) SQUARE
5. BACKSIDE METALLIZATION: GOLD
6. BACKSIDE METAL IS GROUND
7. BOND PAD METALIZATION: GOLD

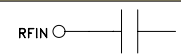
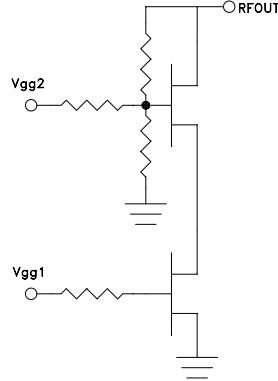
Pad Descriptions

Pad Number	Function	Description	Interface Schematic
5	RFIN	This pin is AC coupled and matched to 50 Ohms from 2.0 - 20.0 GHz	
15	Vgg1	Gate Control for amplifier. Adjust between -2 to 0V to achieve I _{dd} = 290 mA.	
21	RFOUT & V _{dd}	RF output for amplifier. Connect the DC bias (V _{dd}) network to provide drain current (I _{dd}). See application circuit herein.	
30	Vgg2	Control voltage for amplifier. +3V should be applied to Vgg2 for nominal operation.	
Ground Paddle	GND	Ground paddle must be connected to RF/DC ground.	
1-4, 6-14, 16-20, 22-29, 31, 32	N/C	No connection. These pins may be connected to RF ground. Performance will not be affected.	

GaAs PHEMT MMIC POWER AMPLIFIER, 2.0 - 20.0 GHz

Application Circuit

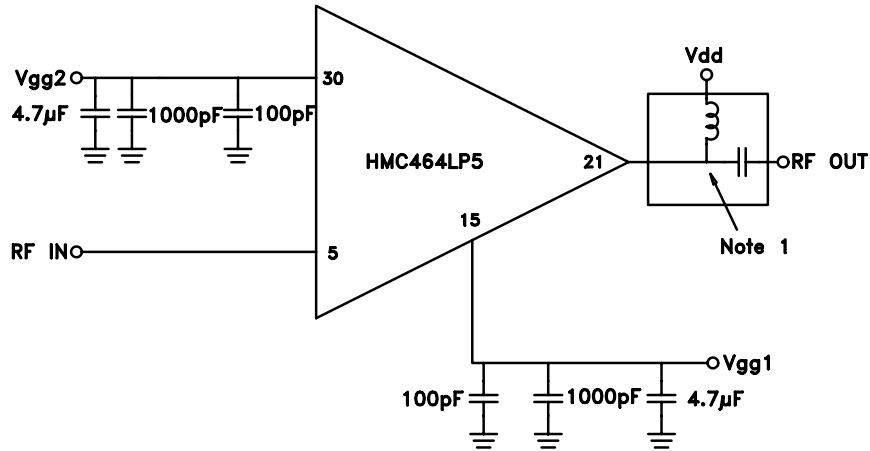

NOTE 1: Drain Bias (Vdd) must be applied through a broadband bias tee or external bias network.

GaAs PHEMT MMIC POWER AMPLIFIER, 2.0 - 20.0 GHz

Evaluation PCB

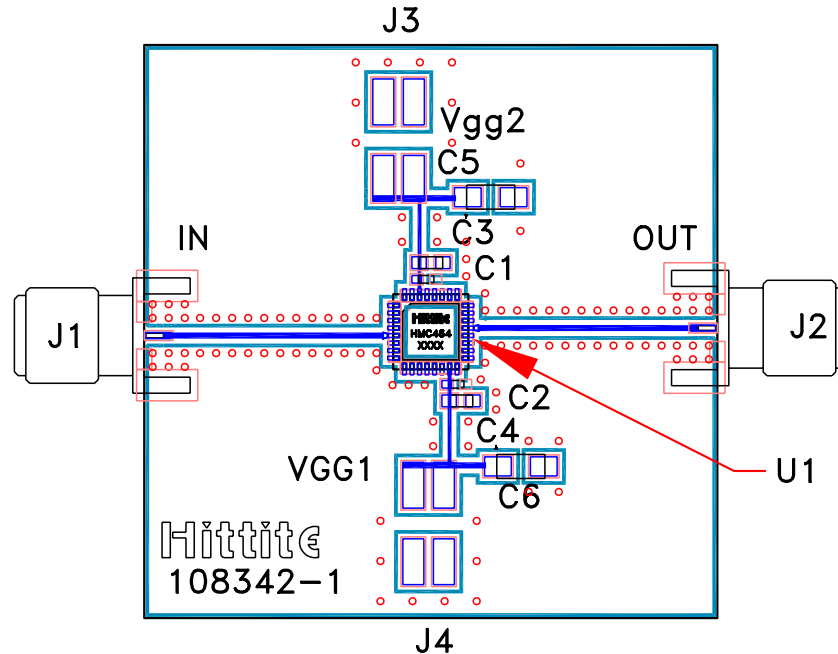

List of Materials for Evaluation PCB 108344*

Item	Description
J1, J2	PC Mount SMA Connector
J3, J4	2 mm Molex Header
C1, C2	100 pF Capacitor, 0402 Pkg.
C3, C4	1000 pF Capacitor, 0603 Pkg.
C5, C6	4.7 μF Capacitor, Tantalum
U1	HMC464LP5
PCB**	108342 Evaluation PCB

** Circuit Board Material: Rogers 4350

The circuit board used in the final application should use RF circuit design techniques. Signal lines should have 50 ohm impedance while the package ground leads and package bottom should be connected directly to the ground plane similar to that shown. A sufficient number of VIA holes should be used to connect the top and bottom ground planes. The evaluation board should be mounted to an appropriate heat sink. The evaluation circuit board shown is available from Hittite upon request.

* Reference this number when ordering complete evaluation PCB.