

### Typical Applications

The HMC484MS8G is ideal for:

- Wireless Infrastructure
- ISM/Cellular Portables/Handsets
- Automotive Telematics
- Mobile Radio
- Test Equipment

### Functional Diagram

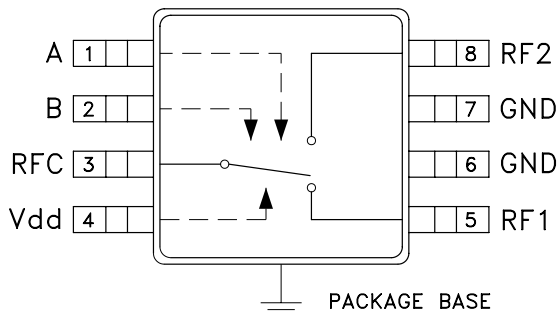

### Features

- High RF Power Handling: > +40 dBm
- High Third Order Intercept: > +70 dBm
- Single Positive Supply: +3 to +10 Vdc
- Low Insertion Loss: 0.4 to 0.6 dB
- Ultra Small MSOP8G Package: 14.8 mm<sup>2</sup>

### General Description

The HMC484MS8G is a low-cost SPDT switch in an 8-lead MSOPG package for use in transmit-receive applications which require very low distortion at high input signal power levels, through 10 watts (+40 dBm). The device can control signals from DC to 3.0 GHz. The design provides exceptional intermodulation performance; > +70 dBm third order intercept at +5 volt bias. RF1 and RF2 are reflective shorts when "OFF". On-chip circuitry allows single positive supply operation from +3 Vdc to +10 Vdc at very low DC current with control inputs compatible with CMOS and most TTL logic families.

### Electrical Specifications,

$T_A = +25^\circ\text{C}$ ,  $V_{ctl} = 0/+5\text{ Vdc}$ ,  $V_{dd} = +5\text{ Vdc}$  (Unless Otherwise Stated), 50 Ohm System

Parameter	Frequency	Min.	Typ.	Max.	Units
Insertion Loss	DC - 1.0 GHz		0.4	0.6	dB
	DC - 2.0 GHz		0.6	0.8	dB
	DC - 2.5 GHz		0.8	1.1	dB
	DC - 3.0 GHz		0.9	1.3	dB
Isolation	DC - 3.0 GHz	26	30		dB
Return Loss (On State)	DC - 1.0 GHz		24		dB
	DC - 2.0 GHz		20		dB
	DC - 2.5 GHz		17		dB
	DC - 3.0 GHz		13		dB
Input Power for 0.1dB Compression	0.5 - 3.0 GHz	$V_{ctl} = 0/+3\text{V}$	32		dBm
		$V_{ctl} = 0/+5\text{V}$	36		dBm
		$V_{ctl} = 0/+8\text{V}$	39		dBm
Input Power for 1dB Compression	0.5 - 3.0 GHz	$V_{ctl} = 0/+3\text{V}$	32	35.5	dBm
		$V_{ctl} = 0/+5\text{V}$	37	40	dBm
		$V_{ctl} = 0/+8\text{V}$	40	>40	dBm
Input Third Order Intercept (Two-tone input power = +30 dBm each tone)	0.5 - 1.0 GHz		72		dBm
	0.5 - 3.0 GHz		70		dBm
Switching Characteristics	DC - 3.0 GHz	$t_{RISE}, t_{FALL}$ (10/90% RF)	15		ns
		$t_{ON}, t_{OFF}$ (50% CTL to 10/90% RF)	40		ns

## GaAs MMIC 10 WATT T/R SWITCH DC - 3.0 GHz

**Insertion Loss vs. Temperature**

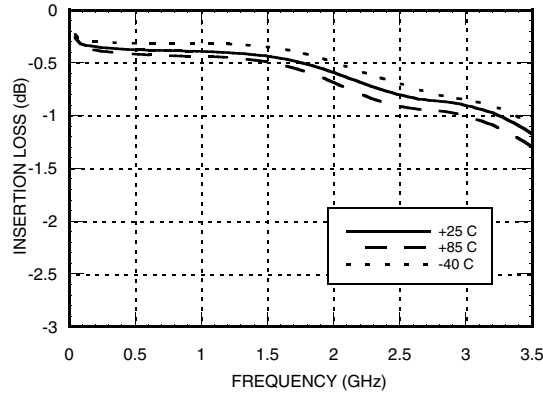

**Isolation**

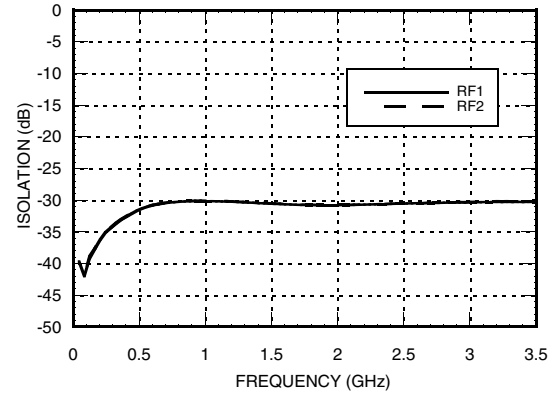

**Insertion Loss vs. Bias Voltage (Vdd)**

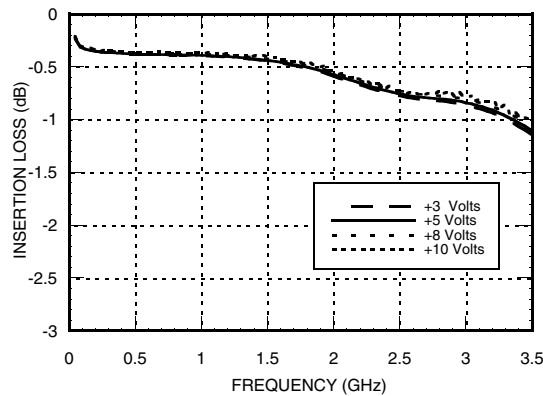

**Isolation vs. Bias Voltage (Vdd)**

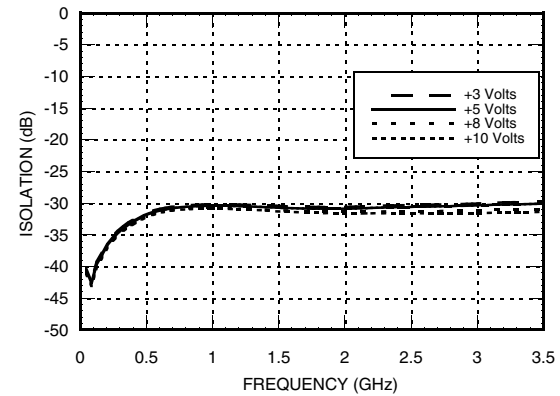

**Return Loss**

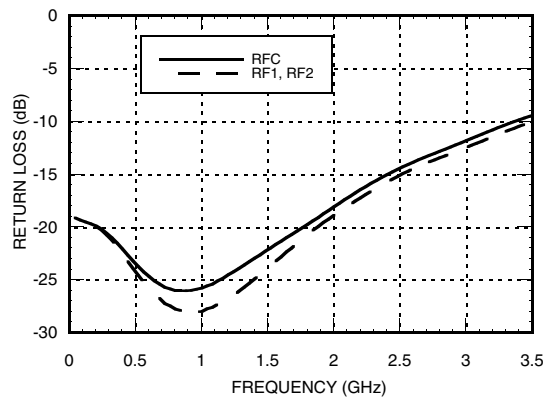

**RF1 to RF2 Isolation**

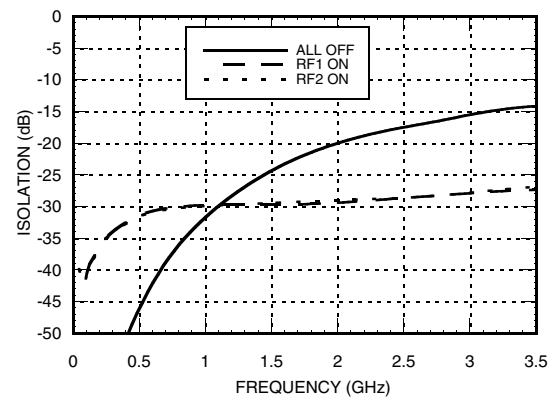

## GaAs MMIC 10 WATT T/R SWITCH DC - 3.0 GHz

**Input P0.1dB vs. Vdd**

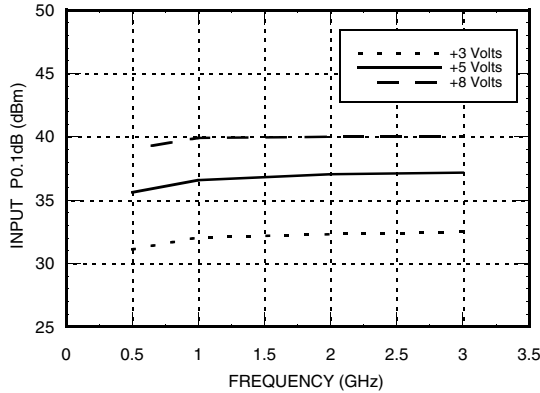

**Input P1dB @ Vdd = +5 Volts**

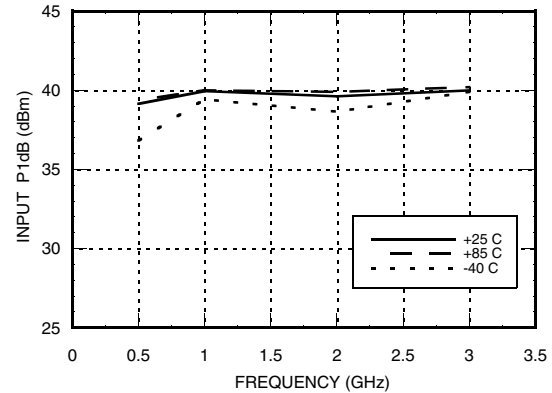

**2nd & 3rd Harmonics @ 900 MHz,  
Vdd = +3 Volts**

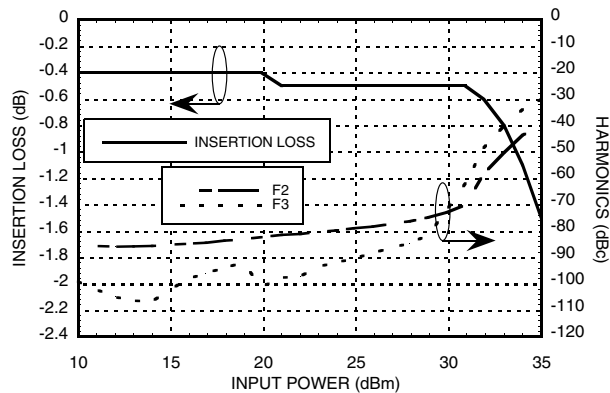

**2nd & 3rd Harmonics @ 900 MHz,  
Vdd = +5 Volts**

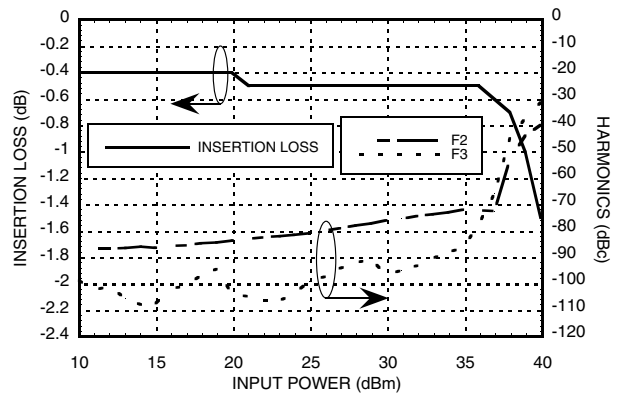

**2nd & 3rd Harmonics @ 900 MHz,  
Vdd = +8 Volts**

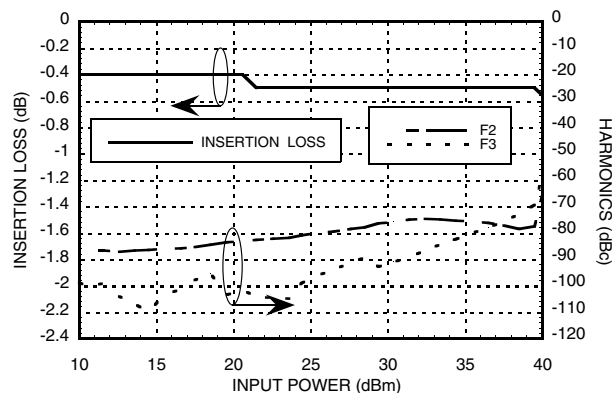

Contact HMC Applications Group for input third order & input compression data from DC - 0.5 GHz.

For price, delivery, and to place orders, please contact Hittite Microwave Corporation:  
12 Elizabeth Drive, Chelmsford, MA 01824 Phone: 978-250-3343 Fax: 978-250-3373  
Order Online at [www.hittite.com](http://www.hittite.com)

## GaAs MMIC 10 WATT T/R SWITCH DC - 3.0 GHz

**Input IP3 @ Vdd = +3 Volts**

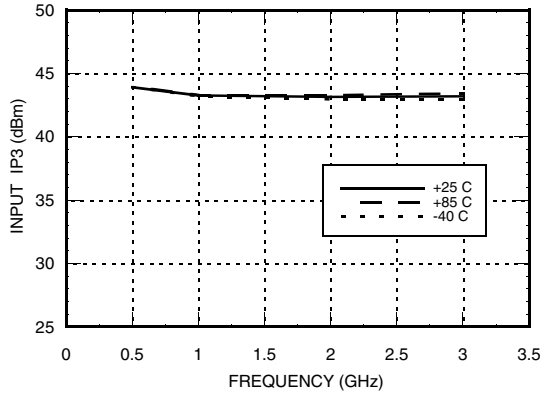

**Input IP3 @ Vdd = +5 Volts**

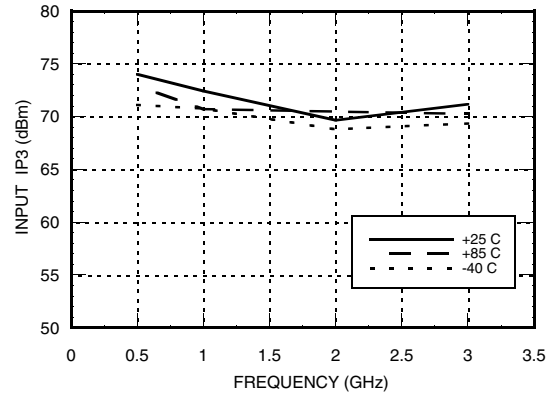

**Input IP3 @ Vdd = +8 Volts**

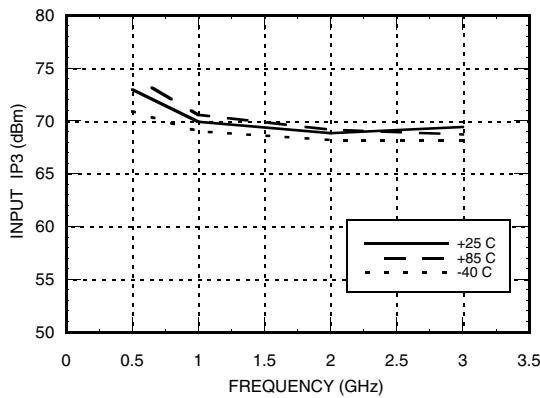

**Input IP3 @ Vdd = +10 Volts**

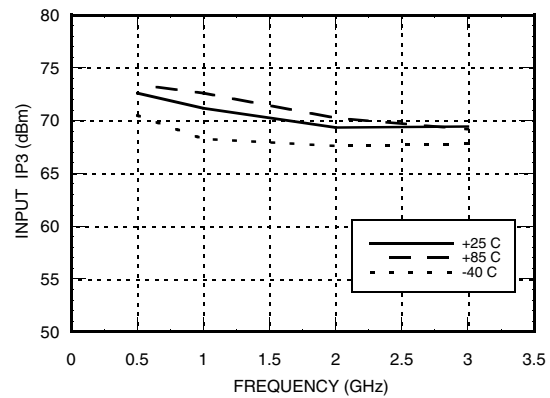

**Input IP3 vs. Input Power @ 900 MHz**

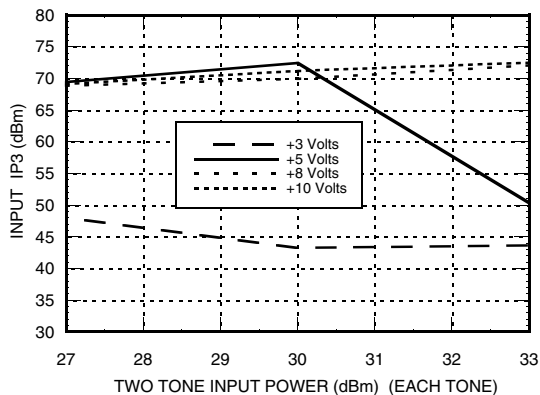

**Input IP3 vs. Input Power @ 1900 MHz**

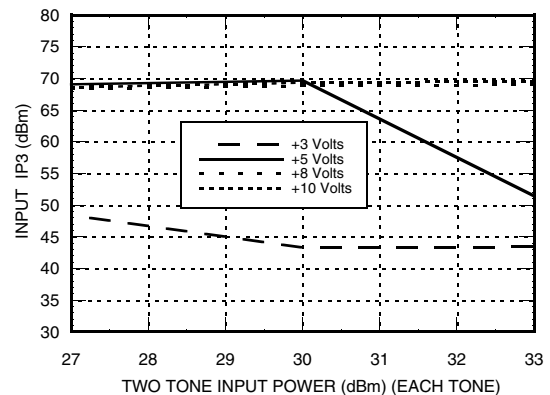

## GaAs MMIC 10 WATT T/R SWITCH DC - 3.0 GHz

### Typical 0.5 to 3.0 GHz Compression vs. Bias Voltage (Vdd)

Bias Vdd	Input Power for 0.1 dB Compression	Input Power for 1.0 dB Compression
(Volts)	(dBm)	(dBm)
+3	32	35.5
+5	36	40
+8	39	>40
+10	>40	>40

### Bias Voltage & Current

Vdd (Vdc)	Typical Idd (µA)
+3	0.5
+5	10
+8	50
+10	75

### Control Voltages

State	Bias Condition
Low	0 to +0.2 Vdc @ 10 µA Typical
High	Vdd ± 0.2 Vdc @ 10 µA Typical

### Absolute Maximum Ratings

RF Input Power (Vctl = 0V/+8V) (0.5 - 3 GHz)	+40 dBm (T = +85 °C)
Supply Voltage Range (Vdd) (Vctl = 0V)	+13 Vdc
Control Voltage Range (A & B)	Vdd - 13 Vdc to Vdd + 0.7 Vdc
Hot Switch Power Level (Vdd = +8V)	39 dBm
Channel Temperature	150 °C
Continuous Pdiss (T = 85 °C) (derate 25 mW/°C above 85 °C)	1.6 W
Thermal Resistance	40 °C/W
Storage Temperature	-65 to +150 °C
Operating Temperature	-40 to +85 °C

Note: DC blocking capacitors are required at ports RFC, RF1 and RF2. Their value will determine the lowest transmission frequency.

### Truth Table

Control Input (Vctl)		Signal Path State	
A	B	RFC to RF1	RFC to RF2
High	Low	Off	On
Low	High	On	Off
Low	Low	Off	Off

### Outline Drawing

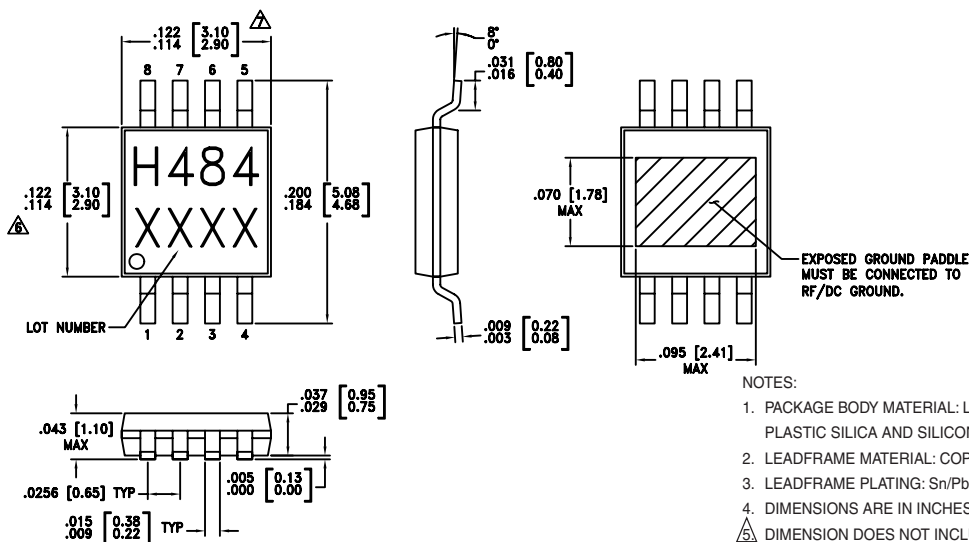

#### NOTES:

- PACKAGE BODY MATERIAL: LOW STRESS INJECTION MOLDED PLASTIC SILICA AND SILICON IMPREGNATED.
- LEADFRAME MATERIAL: COPPER ALLOY
- LEADFRAME PLATING: Sn/Pb SOLDER
- DIMENSIONS ARE IN INCHES [MILLIMETERS].
- DIMENSION DOES NOT INCLUDE MOLDFLASH OF 0.15mm PER SIDE.
- DIMENSION DOES NOT INCLUDE MOLDFLASH OF 0.25mm PER SIDE.
- ALL GROUND LEADS MUST BE SOLDERED TO PCB RF GROUND.
- CLASSIFIED AS MOISTURE SENSITIVITY LEVEL (MSL) 1.

For price, delivery, and to place orders, please contact Hittite Microwave Corporation:  
12 Elizabeth Drive, Chelmsford, MA 01824 Phone: 978-250-3343 Fax: 978-250-3373  
Order Online at [www.hittite.com](http://www.hittite.com)

## GaAs MMIC 10 WATT T/R SWITCH DC - 3.0 GHz

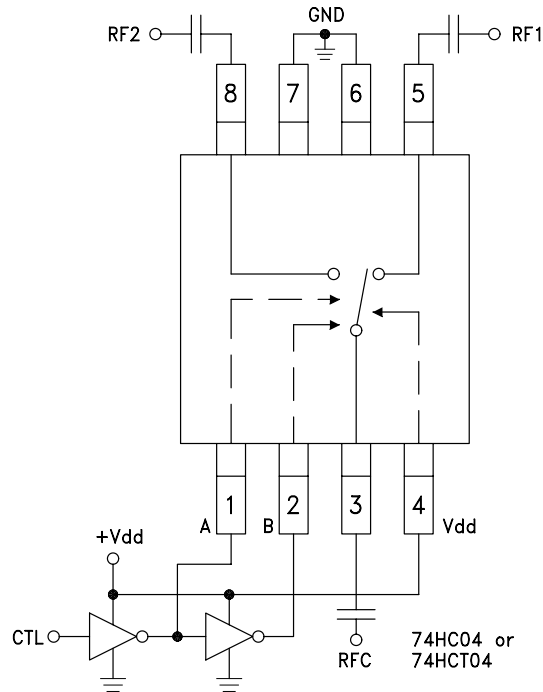

### Typical Application Circuit



**Notes:**

1. Set logic gate and switch Vdd = +3V to +10V and use HCT series logic to provide a TTL driver interface.
2. Control inputs A/B can be driven directly with CMOS logic (HC) with Vdd of +3 to +10 Volts applied to the CMOS logic gates and to pin 4 of the RF switch.
3. DC Blocking capacitors are required for each RF port as shown. Capacitor value determines lowest frequency of operation.
4. Highest RF signal power capability is achieved with V set to +10V. The switch will operate properly (but at lower RF power capability) at bias voltages down to +3V.

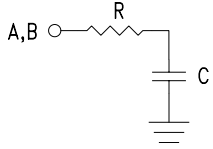
### Pin Descriptions

Pin Number	Function	Description	Interface Schematic
1	A	See truth table and control voltage table.	
2	B	See truth table and control voltage table.	
3, 5, 8	RFC, RF1, RF2	This pin is DC coupled and matched to 50 Ohms. Blocking capacitors are required.	
4	Vdd	Supply Voltage	
6, 7	GND	Package bottom must also be connected to PCB RF ground.	

### Evaluation Circuit Board

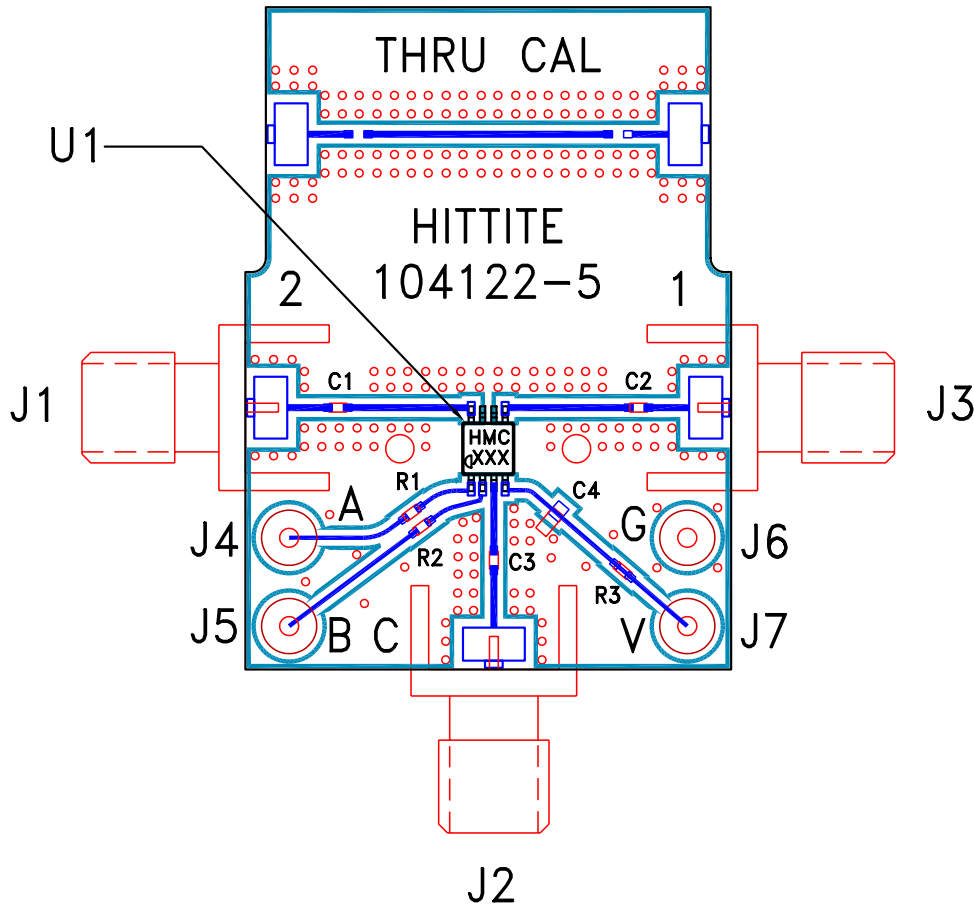

### List of Material for Evaluation PCB 104124\*

Item	Description
J1 - J3	PC Mount SMA RF Connector
J4 - J7	DC Pin
C1 - C3	100 pF capacitor, 0402 Pkg.
C4	10 KpF capacitor, 0603 Pkg.
R1 - R3	100 Ohm Resistor, 0402 Pkg.
U1	HMC484MS8G T/R Switch
PCB**	104122 PCB
** Circuit Board Material: Rogers 4350	

The circuit board used in the final application should be generated with proper RF circuit design techniques. Signal lines at the RF port should have 50 ohm impedance and the package ground leads and package bottom should be connected directly to the ground plane similar to that shown above. The evaluation circuit board shown above is available from Hittite Microwave Corporation upon request.

\*Reference this number when ordering complete evaluation PCB.

## *GaAs MMIC 10 WATT T/R SWITCH DC - 3.0 GHz*

**Notes:**