



GaAs MMIC POSITIVE CONTROL T/R SWITCH, DC - 6.0 GHz

Typical Applications

The HMC536LP2 / HMC536LP2E is ideal for:

- Cellular/PCS/3G Infrastructure
- WiMAX, WiBro & Fixed Wireless
- CATV/CMTS
- Test Instrumentation

Features

- Input P0.1dB: +33 dBm @ +5V
- Insertion Loss: 0.6 dB
- Positive Control: +3V or +5V
- Isolation: 27 dB
- 2x2 mm Leadless DFN SMT Package, 4 mm²

Functional Diagram

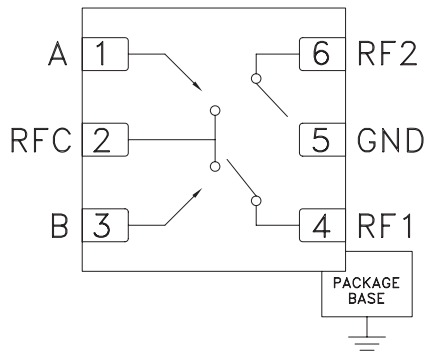

General Description

The HMC536LP2 & HMC536LP2E are DC to 6 GHz GaAs MMIC T/R switches in leadless 2x2 mm DFN LP2 surface mount packages with an exposed ground paddle. The switch is ideal for cellular, WiMAX, & WiBro access point and subscriber applications featuring low 0.6 dB insertion loss and high +54 dBm input IP3. Power handling is excellent up through 6 GHz with the switch offering a P0.1dB compression point of +29 dBm at +3V and +33 dBm at +5V control. On-chip circuitry allows positive voltage control of 0/+3V or 0/+5V at very low DC currents. The HMC536LP2 & HMC536LP2E occupy only 4 mm² and are ideal for applications where small size is required.

Electrical Specifications, $T_A = +25^\circ\text{C}$, $V_{ctl} = 0/+3\text{ Vdc to }+5\text{ Vdc}$, 50 Ohm System

Parameter	Frequency	Min.	Typ.	Max.	Units
Insertion Loss	DC - 3.0 GHz		0.6	0.9	dB
	DC - 4.5 GHz		0.7	1.0	dB
	DC - 6.0 GHz		1.0	1.3	dB
Isolation (RFC to RF1/RF2)	DC - 4.0 GHz	23	27		dB
	4.0 - 5.0 GHz	26	30		dB
	5.0 - 6.0 GHz	24	29		dB
Return Loss	DC - 3.0 GHz		20		dB
	3.0 - 4.0 GHz		20		dB
	4.0 - 6.0 GHz		12		dB
Input Power for 0.1 dB Compression	(Vctl = 3V)	0.5 - 6.0 GHz	27	29	dBm
	(Vctl = 5V)	0.5 - 6.0 GHz	31	33	dBm
Input Third Order Intercept (Two-Tone Input Power = +7 dBm Each Tone)	(Vctl = 3V, 5V)	0.5 - 1.0 GHz		54	dBm
		1.0 - 3.0 GHz		52	dBm
		3.0 - 6.0 GHz		49	dBm
Switching Speed	tRISE, tFALL (10/90% RF)	DC - 6.0 GHz		33	ns
	tON, tOFF (50% CTL to 10/90% RF)			70	ns

GaAs MMIC POSITIVE CONTROL T/R SWITCH, DC - 6.0 GHz

Insertion Loss

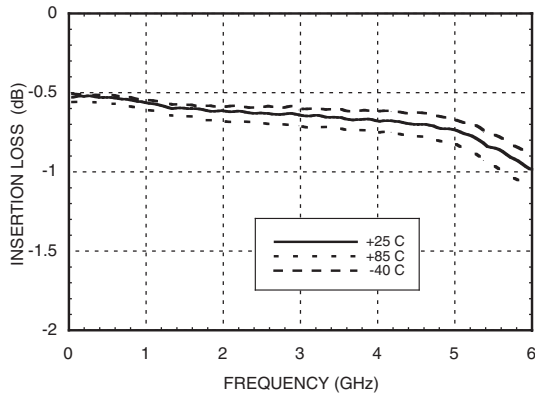

Return Loss

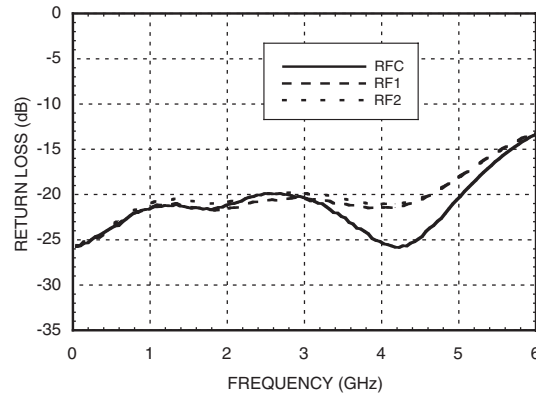

Isolation Between Ports RFC and RF1 / RF2

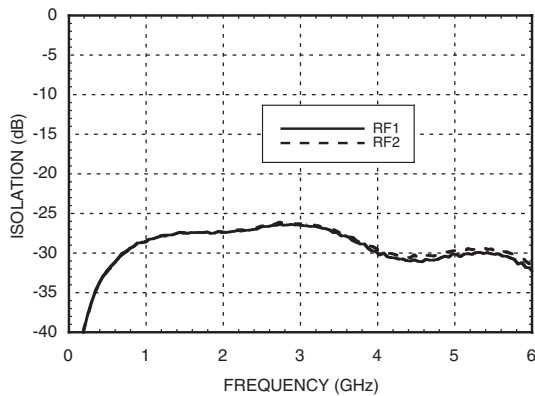

Isolation Between Ports RF1 and RF2

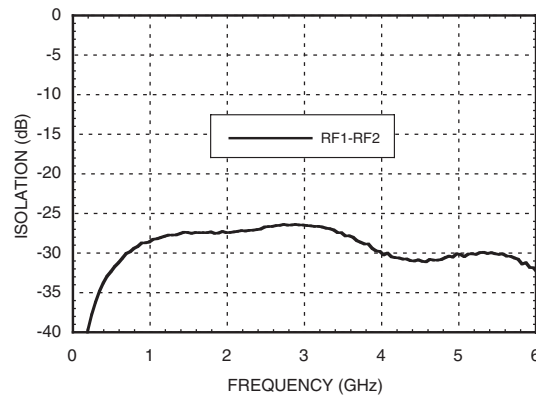

Input 0.1 dB Compression Point

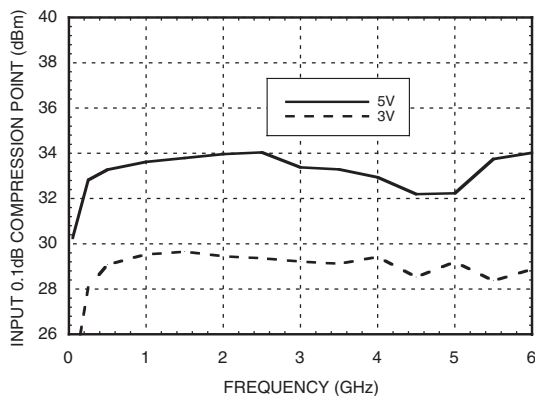

Input Third Order Intercept Point, $V_{ctl} = 3V$

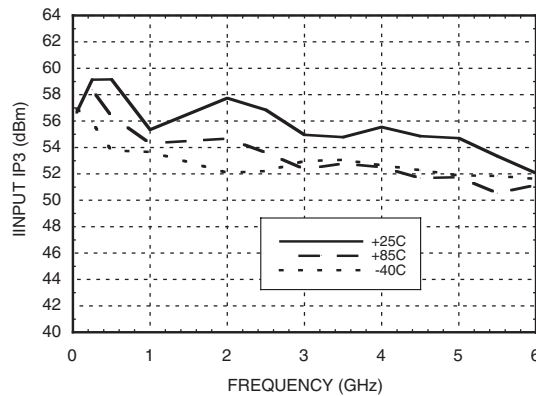

GaAs MMIC POSITIVE CONTROL T/R SWITCH, DC - 6.0 GHz

Absolute Maximum Ratings

Control Voltage Range	-0.5 to +7.5 Vdc
Hot Switch Power Level (Vctl = +3V)	+29 dBm
Channel Temperature	150 °C
Continuous Pdiss (T = 85 °C) (derate 13.3 mW/°C above 85 °C)	0.86 W
Thermal Resistance	75 °C/W
Storage Temperature	-65 to +150 °C
Operating Temperature	-40 to +85 °C
ESD Sensitivity (HBM)	Class 1A

Control Voltages

*Control Input Tolerances are ± 0.2 Vdc

State	Bias Condition*
Low	0 Vdc @ 25 µA Typical
High	+3 Vdc to +5 Vdc @ 25 µA Typical

Truth Table

Control Input		Signal Path State
A	B	RFC to:
Low	High	RF1
High	Low	RF2

DC blocks are required at ports RFC, RF1, RF2.

Choose value for lowest frequency of operation.

Outline Drawing

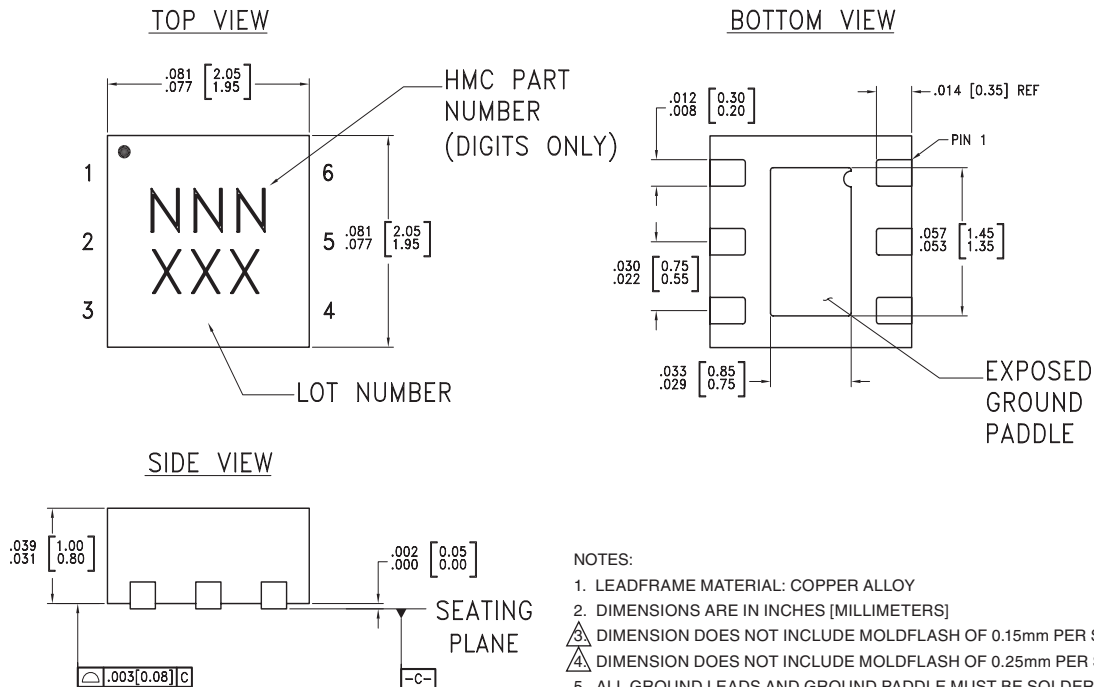

Package Information

Part Number	Package Body Material	Lead Finish	MSL Rating	Package Marking ^[3]
HMC536LP2	Low Stress Injection Molded Plastic	Sn/Pb Solder	MSL1 ^[1]	536 XXX
HMC536LP2E	RoHS-compliant Low Stress Injection Molded Plastic	100% matte Sn	MSL1 ^[2]	536 XXX

[1] Max peak reflow temperature of 235 °C



[2] Max peak reflow temperature of 260 °C

[3] 3-Digit lot number XXX

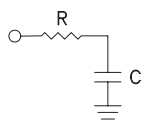

**GaAs MMIC POSITIVE CONTROL
T/R SWITCH, DC - 6.0 GHz**

Pin Descriptions

Pin Number	Function	Description	Interface Schematic
1	A	See truth and control voltage tables.	
3	B	See truth and control voltage tables.	
2, 4, 6	RFC, RF1, RF2	These pins are DC coupled and matched to 50 Ohms. Blocking capacitors are required.	
5	GND	Package bottom has exposed metal paddle that must also be connected to RF/DC ground.	



**GaAs MMIC POSITIVE CONTROL
T/R SWITCH, DC - 6.0 GHz**

Evaluation PCB

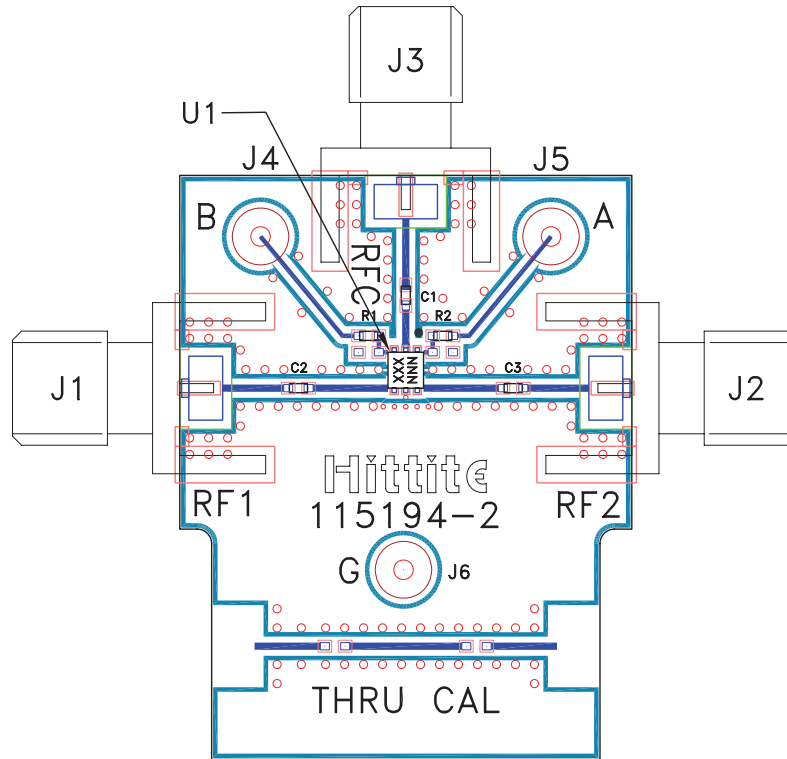

List of Materials for Evaluation PCB 115195 [1]

Item	Description
J1 - J3	PCB Mount SMA RF Connector
J4 - J6	DC Pin
C1 - C3	100 pF Capacitor, 0402 Pkg.
R1 - R2	1K Ohm Resistor, 0402 Pkg.
U1	HMC536LP2 / HMC536LP2E SPDT Switch
PCB [2]	115194 Evaluation PCB

[1] Reference this number when ordering complete evaluation PCB

[2] Circuit Board Material: Rogers 4350

The circuit board used in the final application should be generated with proper RF circuit design techniques. Signal lines at the RF port should have 50 ohm impedance and the package ground leads and exposed paddle should be connected directly to the ground plane similar to that shown above. The evaluation circuit board shown above is available from Hittite Microwave Corporation upon request.



MICROWAVE CORPORATION v00.0606



HMC536LP2 / 536LP2E

www.DataSheet4U.com

**GaAs MMIC POSITIVE CONTROL
T/R SWITCH, DC - 6.0 GHz**

Notes:



SWITCHES - SMT