



MILLIMETERWAVE TRANSMITTER 57 - 64 GHz

Typical Applications

The HMC6000LP711E is ideal for:

- WiGig Single Carrier Modulations
- 60 GHz ISM Band Data Transmitter
- Multi-Gbps Data Communications
- High Definition Video Transmission
- RFID

General Description

The HMC6000LP711E is a complete mmWave transmitter IC and low profile antenna integrated in a plastic 7x11 mm surface mount package. The transmitter provides 23.5 dBm of EIRP operating over 57 - 64 GHz with 1.8 GHz of modulation bandwidth. An integrated synthesizer provides tuning in 500 or 540 MHz step sizes depending on the choice of external reference clock. Support for a wide variety of modulation formats is provided through a universal analog baseband IQ interface. Together with the HMC6001LP711E, a complete transmit/receive chipset is provided for multi-Gbps operation in the unlicensed 60 GHz ISM band.

Features

- Support for IEEE Channel Plan
- EIRP: 23.5 dBm
- Output Power: 16 dBm
- Antenna Gain: 7.5 dBi
- Max Gain: 38 dB
- Gain Control Range: 17 dB
- Integrated Frequency Synthesizer
- Integrated Image Reject Filter
- Programmable IF Gain Block
- Universal Analog I/Q Baseband Interface
- Three-Wire Serial Digital Interface
- 7x11mm QFN Package: 77mm²

Functional Diagram

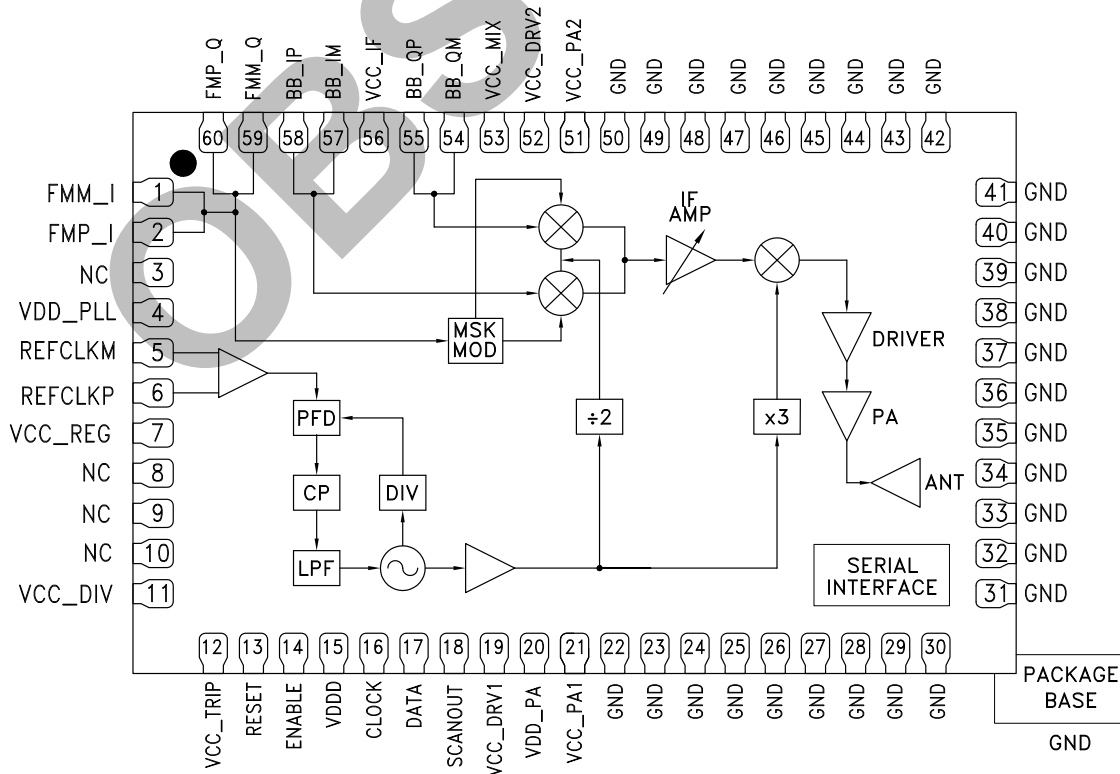

Information furnished by Analog Devices is believed to be accurate and reliable. However, no responsibility is assumed by Analog Devices for its use, nor for any infringements of patents or other rights of third parties that may result from its use. Specifications subject to change without notice. No license is granted by implication or otherwise under any patent or patent rights of Analog Devices. Trademarks and registered trademarks are the property of their respective owners.

For price, delivery, and to place orders: Analog Devices, Inc., One Technology Way, P.O. Box 9106, Norwood, MA 02062-9106 Phone: 781-329-4700 • Order online at www.analog.com Application Support: Phone: 1-800-ANALOG-D

**MILLIMETERWAVE TRANSMITTER
57 - 64 GHz**
Table 1. Electrical Specifications, TA = +25° C, See Test Conditions

Parameter	Condition	Min.	Typ.	Max.	Units
Frequency Range		57		64	GHz
Frequency Step Size	308.5714 MHz Ref Clk		0.54		GHz
Frequency Step Size	285.714 MHz Ref Clk		0.50		GHz
Modulation Bandwidth	3dB BW, double-sided		1.8		GHz
Max Gain	Pout measured at IC, minus total Pin of all 4 baseband inputs [1]		38		dB
Gain Control Range			17		dB
Gain Step Size			1.3		dB
EIRP [2]	Combined Psat and antenna peak gain measured on evaluation board		23.5		dBm
P1dB	Pout measured at IC [1]		11		dBm
Psat	Pout measured at IC [1]		16		dBm
Antenna Gain	Antenna measured on evaluation board		7.5		dBi
Image Rejection			34		dB
Sideband Suppression			20		dB
Carrier Suppression			20		dB
3xLO Suppression			32		dBc
Phase Noise @ 100 kHz			-72		dBc/Hz
Phase Noise @ 1 MHz			-86		dBc/Hz
Phase Noise @ 10 MHz			-111		dBc/Hz
Phase Noise @ 100 MHz			-125		dBc/Hz
Phase Noise @ 1 GHz			-127		dBc/Hz
PLL Loop BW	Internal Loop Filter		200		kHz
Power Dissipation			0.8		W

[1] Measurement does not include antenna gain.
[2] Effective Isotropic Radiated Power (EIRP)

Table 2. Test Conditions

Reference frequency	308.5714 MHz
Temperature	+25°C
Gain Setting	Max
Input Signal Level	-31 dBm @ each of the 4 baseband inputs
IF Bandwidth	Max
Input Impedance	100Ω Differential
Output Impedance	100Ω Differential



MILLIMETERWAVE TRANSMITTER 57 - 64 GHz

Table 3. Recommended Operation Conditions

Description	Symbol	Min	Typical	Max	Units
Analog Ground	GND		0		Vdc
Power Supplies	VCC_PA1 VCC_PA2	3.9	4.0	4.1	Vdc
	VDD_PA VCC_DRV VCC_TRIP VCC_DIV VCC_REG VCC_IF VCC_MIX	2.565	2.7	2.835	Vdc
	VDD_PLL	1.3	1.35	1.48	Vdc
	VDDD				Vdc
Input Voltage Ranges					
Serial Digital Interface – Logic High	DATA ENABLE CLOCK RESET	0.9	1.2	1.4	V
Serial Digital Interface – Logic Low	DATA ENABLE CLOCK RESET	-0.05	0.1	0.3	V
Reference Clock	REFCLKP REFCLKM		3.3 or 2.5V LVPECL/LVDS 1.2V CMOS		V
Baseband I and Q [1][2]	BB_IM BB_IP BB_QM BB_QP	5	25	100	mVp-p
Baseband I and Q Common mode			1.6		V
MSK Data [2]	FMM_I FMP_I FMM_Q FMP_Q	200	500	750	mVp-p
MSK Common mode			1.1		V
Input Resistance	DATA ENABLE CLOCK RESET		>50		kOhms
	REFCLKP / M		50		Ohm
Temperature		-40		+85	C
<p>[1] Values above 25 mVp-p are to be used only with IF attenuation to keep the Pout below 16 dBm [2] Baseband voltage at each of the four baseband inputs.</p>					



MILLIMETERWAVE TRANSMITTER
57 - 64 GHz

Table 4. Power Consumption

Voltage	Typical Current (mA)	Typical Power Consumption (Watts)
VCC_PA1 (4.0Vdc)	33	0.27
VCC_PA2 (4.0Vdc)	33	
VCC_REG (2.7Vdc)	12	
VCC_DRV1 (2.7Vdc)	16	
VCC_DRV2 (2.7Vdc)	16	
VCC_MIX (2.7Vdc)	29	
VCC_IF (2.7Vdc)	31	0.53
VCC_TRIP (2.7Vdc)	48	
VCC_DIV (2.7Vdc)	35	
VDD_PA (2.7Vdc)	6	0.01
VDDD (1.35Vdc)	<1	
VDD_PLL (1.35Vdc)	8	

Figure 1. EIRP vs. Frequency at Maximum Gain^{[1][2]}

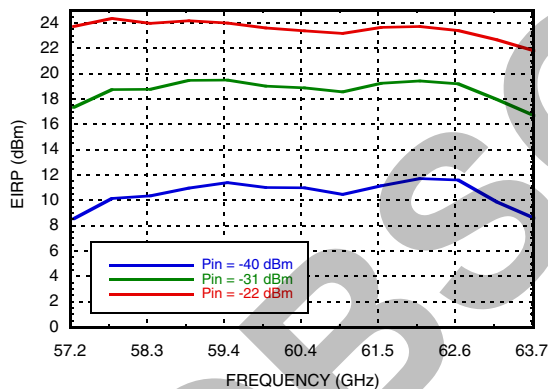

Figure 2. Antenna Peak Gain vs. Frequency^[2]

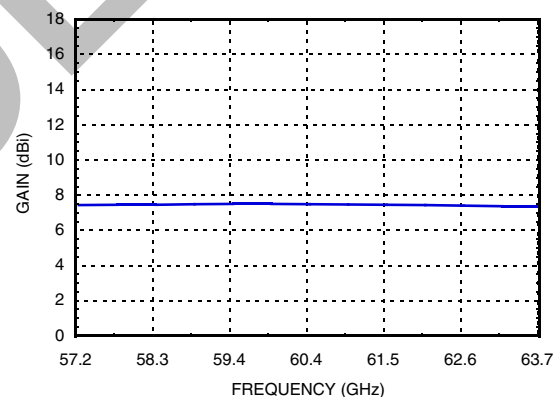

Figure 3. Antenna Gain vs. E-Plane Angle^[2]

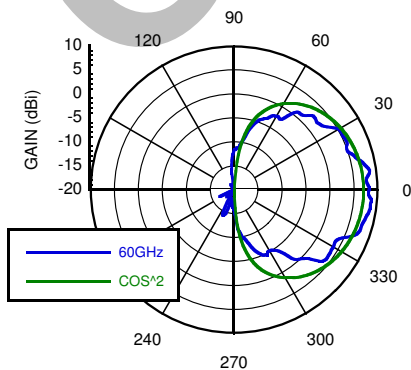
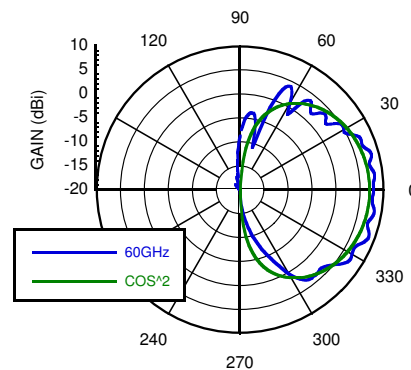

Figure 4. Antenna Gain vs. H-Plane Angle^[2]



[1] Effective Isotropic Radiated Power (EIRP) with input power of -40, -31, and -22dBm applied at each of the 4 baseband inputs, calculated at peak antenna gain.

[2] Antenna patterns and gain are measured on packages mounted on the Evaluation PCB Daughtercard (see p. 10).



**MILLIMETERWAVE TRANSMITTER
57 - 64 GHz**

Figure 5. Output Power vs. Frequency at Maximum Gain^{[3][4]}

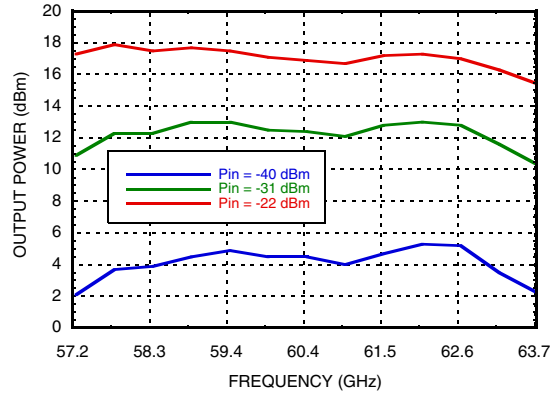

Figure 6. P1dB vs. Frequency Over Temperature^[4]

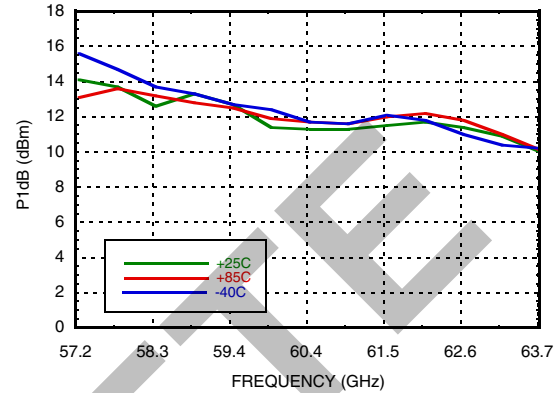

Figure 7. P1dB vs. Frequency Across Voltage^[4]

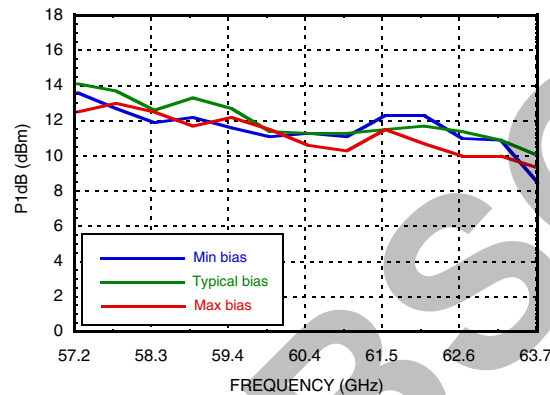

Figure 8. 58.32 GHz (IEEE CH-1) Output Power vs. IF Gain Setting^{[3][4]}

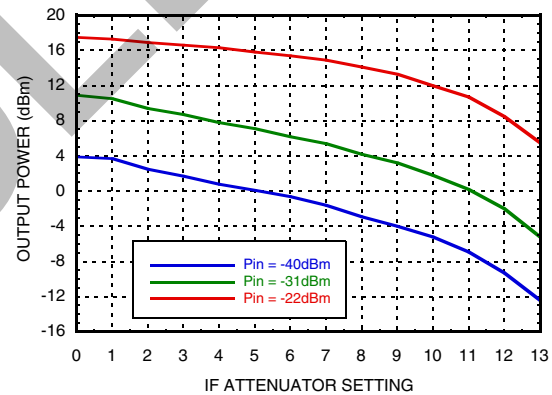

Figure 9. 60.48 GHz (IEEE CH-2) Output Power vs. IF Gain Setting^{[3][4]}

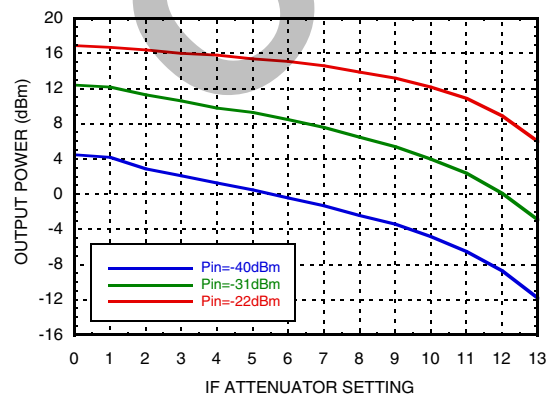
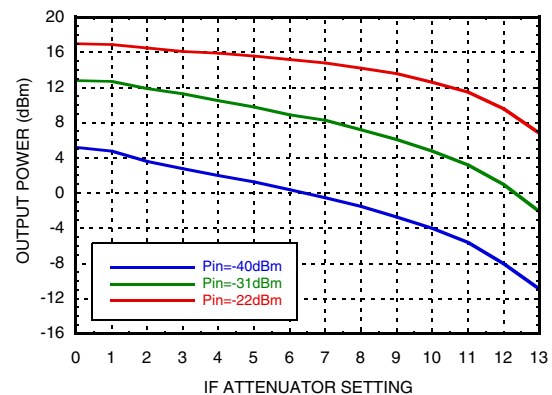

Figure 10. 62.64 GHz (IEEE CH-3) Output Power vs. IF Gain Setting^{[3][4]}



[3] Input power of -40, -31, and -22dBm applied at each of the 4 baseband inputs.

[4] Measured without antenna gain.



MILLIMETERWAVE TRANSMITTER
57 - 64 GHz

Figure 11. Gain vs. Frequency Over Temperature^{[4][5]}

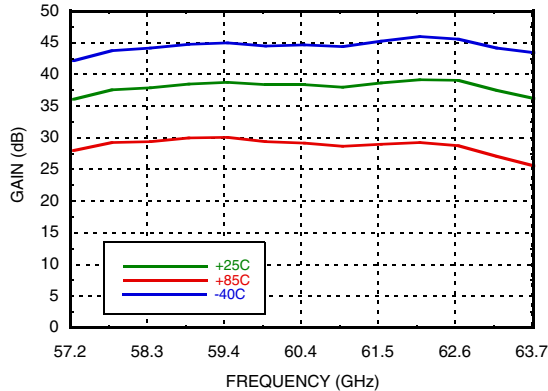

Figure 12. Sideband Suppression vs. Frequency Over Temperature^{[6][7][8]}

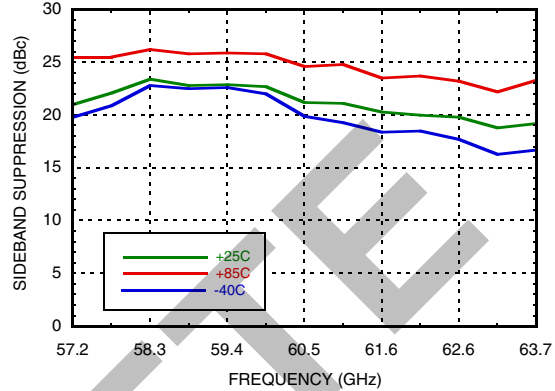

Figure 13. Sideband Suppression vs. Frequency Across Voltage^{[6][7][8]}

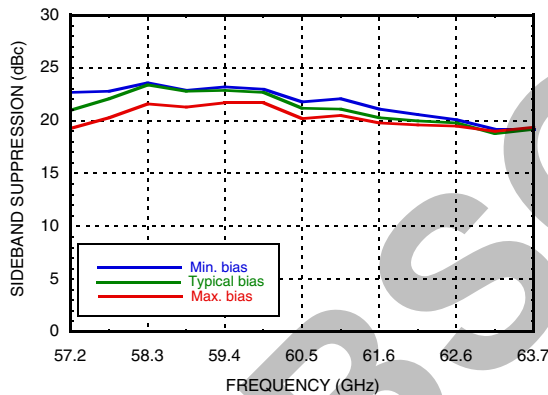

Figure 14. Image Rejection vs. Frequency Over Temperature^{[6][8]}

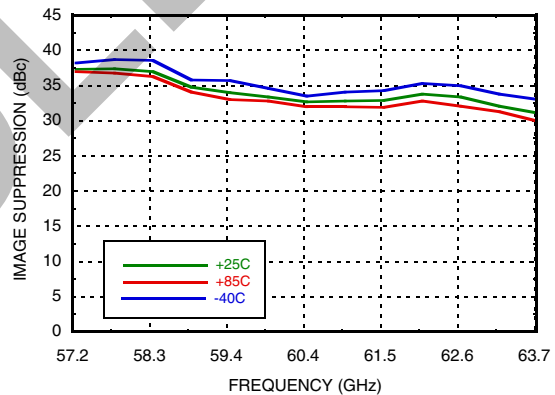

Figure 15. Image Rejection vs. Frequency Across IF Gain^[8]

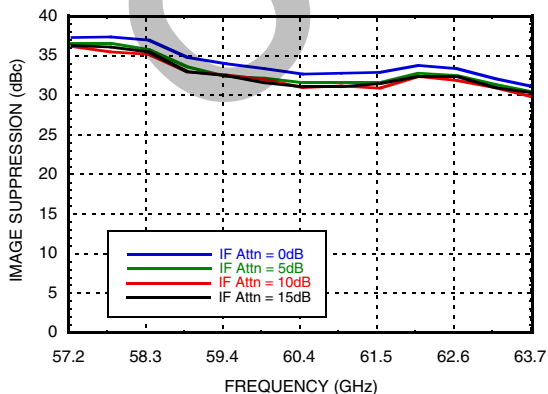
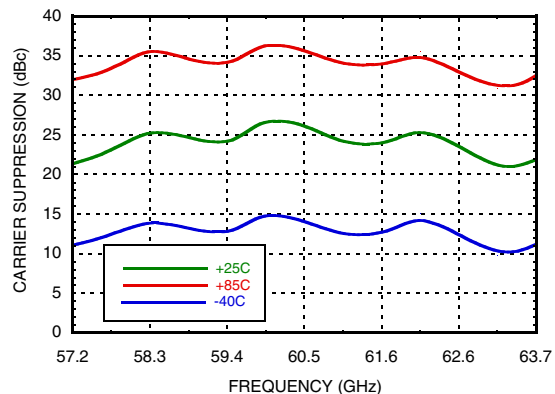

Figure 16. Carrier Suppression vs. Frequency Over Temperature^{[6][8]}



[4] Measured without antenna gain.

[5] Input power of -40dBm applied at each of the 4 baseband inputs, Gain=Pout at the IC, minus total Pin of all 4 baseband inputs.

[6] Specified at max gain settings.

[7] Specified at sideband offset = 100MHz.

[8] Input power of -31dBm applied at each of the 4 baseband inputs.



**MILLIMETERWAVE TRANSMITTER
57 - 64 GHz**

Figure 17. 3x LO Suppression vs. Frequency Over Temperature^{[6][9]}

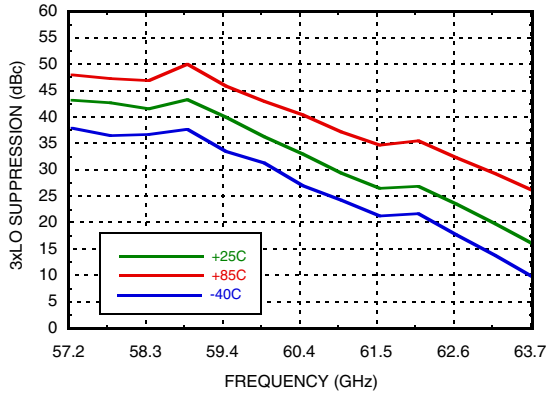

Figure 18. 3x LO Suppression vs. Frequency Across IF Gain^[8]

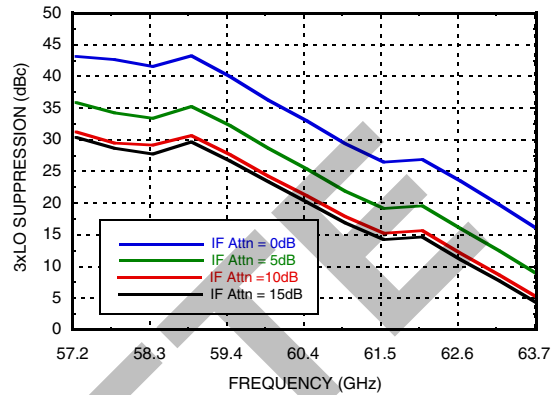

Figure 19. 2xLO vs. Frequency Across IF Gain^[8]

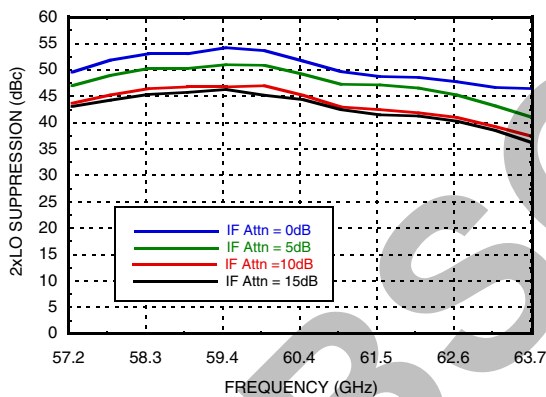

Figure 20. Phase Noise vs. Frequency Offset Over Temperature^[10]

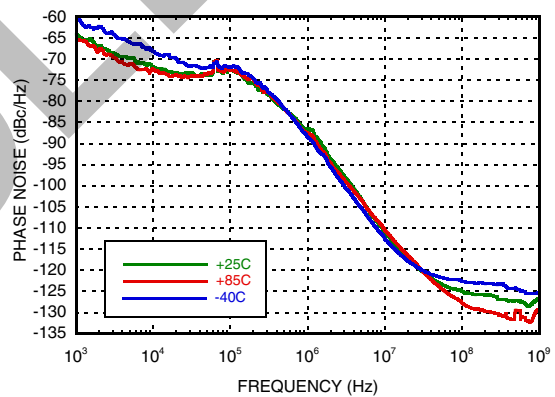
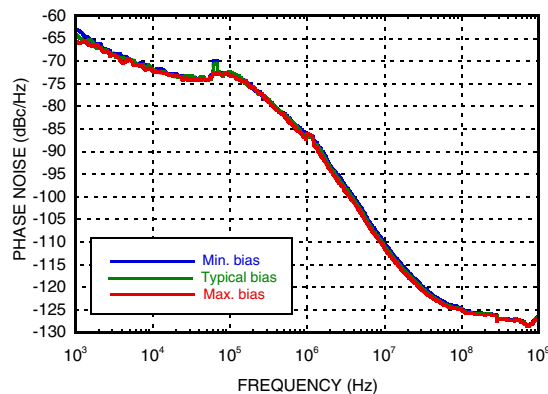

Figure 21. Phase Noise vs. Frequency Offset Over Voltage^[10]



[6] Specified at max gain settings.

[8] Input power of -31dBm applied at each of the 4 baseband inputs.

[9] Input power applied at each of the 4 baseband inputs: -22dBm (+25C), -31dBm (+85C), -40dBm (-40C).

[10] Measured with a 60.48 GHz carrier.



MILLIMETERWAVE TRANSMITTER 57 - 64 GHz

Table 5. Absolute Maximum Ratings

VCC_PA = 4 V	4.2 Vdc
VDD = 2.7 V	2.85 Vdc
VCC = 2.7 V	2.85 Vdc
VDD_PLL = 1.35 V	1.6 Vdc
VDDD = 1.35 V	1.6 Vdc
GND	0± 50 mV
Junction Temperature	125°C
Continuous Pdiss (T=85°C) (derate 29mW/°C above 85°C)	1.10 W
Thermal Resistance (Rth) (Junction to ground paddle)	34 °C/W
Serial Digital Interface Input Voltage	1.5 Vdc
Ref CLK Input (AC coupled)(each)	0.75 Vp-p
Baseband Inputs (BB, FM)(each)	0.75 Vp-p
Storage Temperature	-55°C to 150°C
Operating Temperature	-40°C to 85°C
ESD Sensitivity (HBM)	Class 0, Pass at 200V

Stresses above those listed under Absolute Maximum Ratings may cause permanent damage to the device. This is a stress rating only; functional operation of the device at these or any other conditions above those indicated in the operational section of this specification is not implied. Exposure to absolute maximum rating conditions for extended periods may affect device reliability.

Outline Drawing

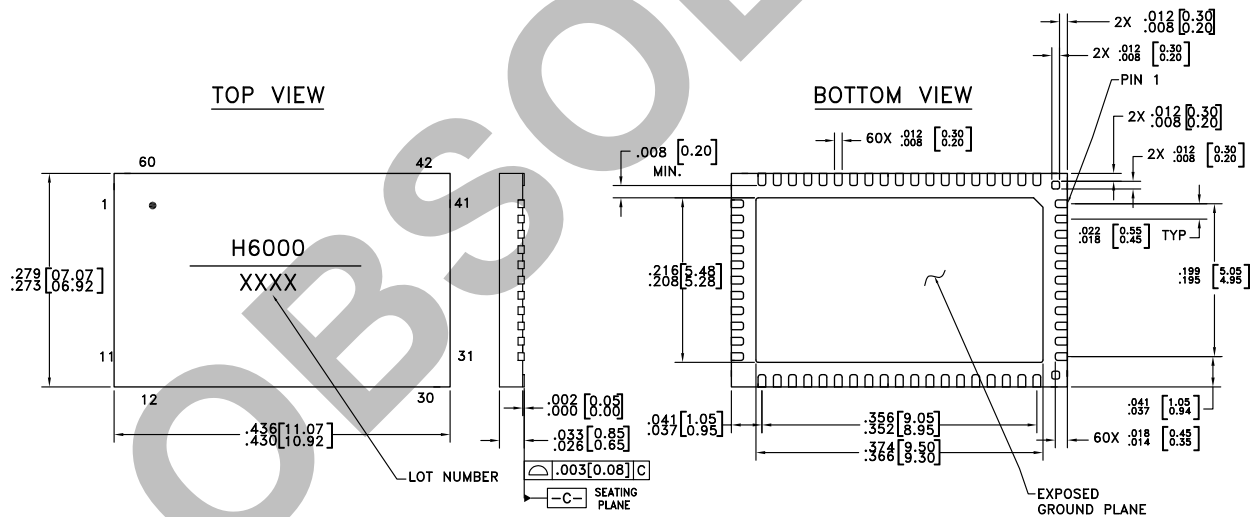

NOTES:

1. ALL DIMENSIONS ARE IN INCHES [MM]
2. LEAD SPACING TOLERANCE IS NON-CUMULATIVE.
3. PAD BURR LENGTH SHALL BE 0.15 mm MAX. PAD BURR HEIGHT SHALL BE 0.05 mm MAX.
4. PACKAGE WARP SHALL NOT EXCEED 0.05 mm
5. ALL GROUND LEADS AND GROUND PADDLE MUST BE SOLDERED TO PCB RF GROUND
6. REFER TO HITTITE APPLICATION NOTE FOR SUGGESTED PCB LAND PATTERN..

Table 6. Package Information

Part Number	Package Body Material	Lead Finish	MSL Rating	Package Marking
HMC6000LP711E	RoHS-compliant Low Stress Injection Molded Plastic Silica and Silicon	100% matte Sn	MSL3	H6000 XXXX

[1] 4-Digit lot number XXXX



**MILLIMETERWAVE TRANSMITTER
57 - 64 GHz**
Table 7. Pin Descriptions

Pin Number	Function	Description
1	FMM_I	FSK negative in-phase input – DC coupled - 50Ω
2	FMP_I	FSK positive in-phase input – DC coupled - 50Ω
3,8-10	NC	These pins are not connected internally
4	VDD_PLL	1.35V supply (VCO)
5	REFCLKM	Xtal REF CLK Minus - AC or DC coupled - 50Ω
6	REFCLKP	Xtal REF CLK Plus - AC or DC coupled - 50Ω
7	VCC_REG	2.7V supply (VCO)
11	VCC_DIV	2.7V supply (Divider)
12	VCC_TRIP	2.7V supply (Tripler)
13	RESET	Asynchronous reset-all registers (1.2V CMOS, active high)
14	ENABLE	Serial digital interface enable (1.2V CMOS) - 50kΩ
15	VDDD	1.35V supply (serial digital interface)
16	CLOCK	Serial digital interface clock (1.2V CMOS) - 50kΩ
17	DATA	Serial digital interface data (1.2V CMOS) - 50kΩ
18	SCANOUT	Serial digital interface out (1.2V CMOS) - 50kΩ
19	VCC_DRV1	2.7V supply (Driver)
20	VDD_PA	2.7V supply (PA)
21	VCC_PA1	4.0V supply (PA)
22-50	GND	These pins and package bottom must be connected to RF/DC ground externally.
51	VCC_PA2	4.0V supply (PA)
52	VCC_DRV2	2.7V supply (Driver)
53	VCC_MIX	2.7V (Mixer)
54	BB_QM	Baseband negative quadrature input – DC coupled - 50Ω
55	BB_QP	Baseband positive quadrature input – DC coupled - 50Ω
56	VCC_IF	2.7V supply (IF)
57	BB_IM	Baseband negative in-phase input – DC coupled - 50Ω
58	BB_IP	Baseband positive in-phase input – DC coupled - 50Ω
59	FMM_Q	FSK negative quadrature input – DC coupled - 50Ω
60	FMP_Q	FSK positive quadrature input – DC coupled - 50Ω

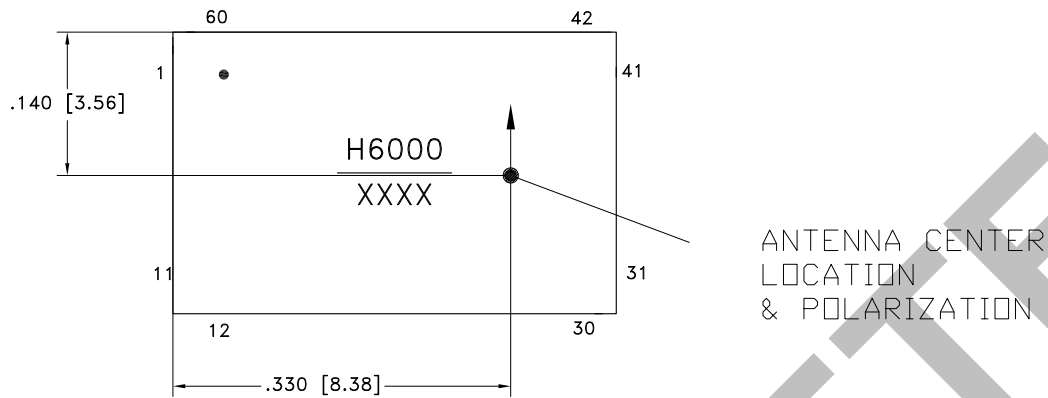

**MILLIMETERWAVE TRANSMITTER
57 - 64 GHz**

Antenna-in-Package Location and Polarization



The antenna is located inside the package with geometric center and linear polarization angle as shown. The geometric center can be used as the antenna pattern phase center provided there is sufficient unobstructed ground plane extension around the chip. Measured antenna pattern phase centers will vary with frequency and are dependent on finite ground plane effects, and coupling to nearby components.

Evaluation PCB Daughtercard

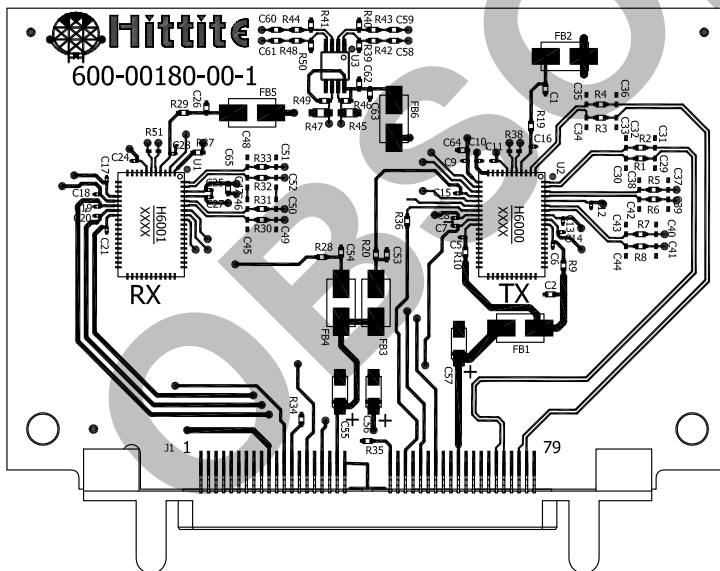

The circuit board used in the application should use RF circuit design techniques. Signal lines should have 50 Ohm impedance while the package ground leads and exposed paddle should be connected directly to the ground plane similar to that shown. A sufficient number of via holes should be used to connect the top and bottom ground planes. The evaluation circuit board shown is part of an evaluation kit available from Hittite.



MILLIMETERWAVE TRANSMITTER
57 - 64 GHz

Evaluation PCB Motherboard

MMWAVE TRANSMITTER - SMT

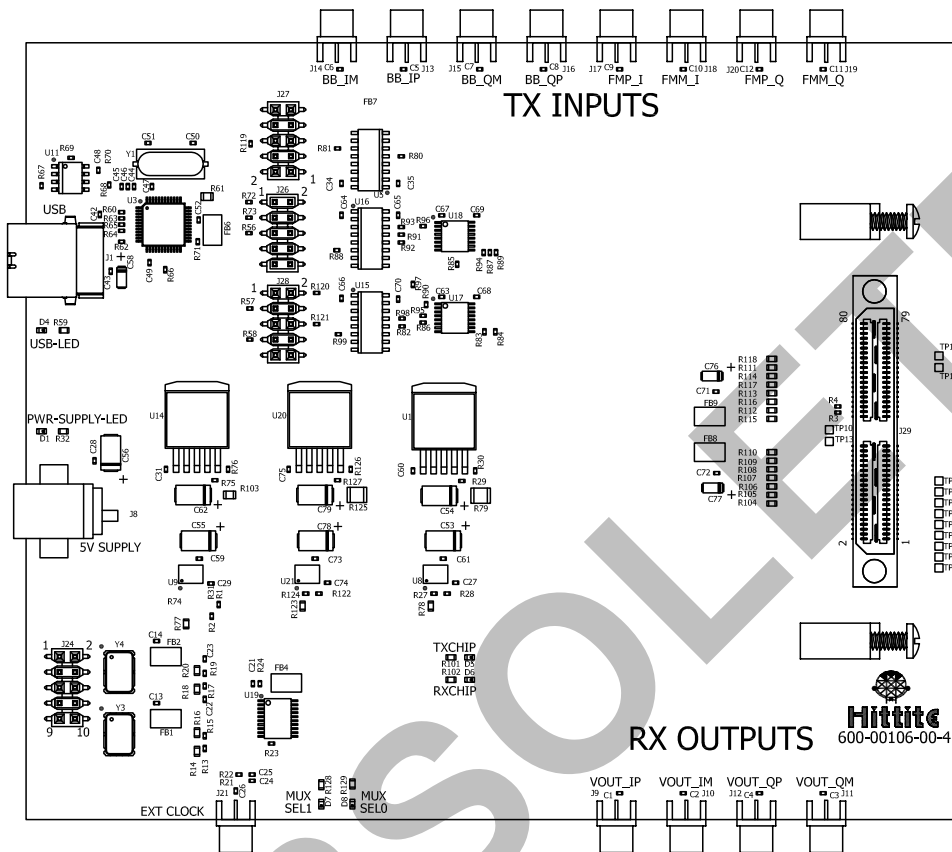

Evaluation PCB Schematics

To view the Evaluation PCB Schematics please visit www.hittite.com and choose HMC6000LP711E from the “Search by Part Number” pull down menu to view the product splash page.

Evaluation Kit

The HMC6450 evaluation kit contains everything that is needed to set up a bi-directional 60 GHz millimeter-wave link using standard RF cable interfaces for baseband input and output. Kit comes with two motherboard PCBs that provide on board crystals, USB interface, supply regulators, and SMA cables for connectorized IQ interfaces. Supplied software allows the user to read from and write to all chip level registers using a Graphical User Interface (GUI) or upload previously saved register settings.

Evaluation Kit Order Information

Item	Contents	Part Number
Evaluation Kit	2 Daughtercard Evaluation PCBs with HMC6000LP711E and HMC6001LP711E 2 Motherboard Evaluation PCBs with crystals, USB Interface, supply regulators and MCX connectorized IQ interface. 2 Wall mount power supplies. 2 USB A Male to USB B Female Cable 8 Phase matched MCX to SMA Cables CD ROM (Contains User Manual, Evaluation PCB Schematic, Evaluation Software)	HMC6450



MILLIMETERWAVE TRANSMITTER
57 - 64 GHz

Theory of Operation

An integrated frequency synthesizer creates a low-phase noise LO between 16.3 and 18.3 GHz. The step size of the synthesizer equates to 540MHz steps at RF when used with 308.5714 MHz reference crystal (compatible with the IEEE channels of the ISM band) or 500 MHz steps if used with a 285.714 MHz reference crystal.

If the chip is configured for IQ baseband input, these signals are quadrature modulated onto an 8 to 9.1GHz sliding IF using the synthesized LO divided by two. There are also options to input AM/FM/FSK/MSK waveforms directly to the on-chip IF modulators. Contact Hittite application support for further guidance and application notes if interested in these modes. The IF signal is then filtered and amplified with 17 dB of variable gain, then mixed with three times the LO frequency to upconvert to an RF frequency between 57 and 64 GHz. Integrated notch filters attenuate the lower mixing product at 40-46GHz. Two RF amplifier stages provide gain to allow up to 11 dBm differential output from the IC to an integrated low profile antenna.

The phase noise and quadrature balance of the HMC6000LP711E is sufficient to carry up to 16QAM modulation for high data rate operation..

There are no special power sequencing requirements for the HMC6000LP711E; all voltages are to be applied simultaneously.

Register Array Assignments and Serial Interface

The register arrays for both the transmitter and receiver are organized into 16 rows of 8 bits. Using the serial interface, the arrays are written or read one row at a time as shown in Figure 22 and Figure 23, respectively. Figure 22 shows the sequence of signals on the ENABLE, CLK, and DATA lines to write one 8-bit row of the register array. The ENABLE line goes low, the first of 18 data bits (bit 0) is placed on the DATA line, and 2 ns or more after the DATA line stabilizes, the CLK line goes high to clock in data bit 0. The DATA line should remain stable for at least 2 ns after the rising edge of CLK.

The Tx IC will support a serial interface running up to several hundred MHz, and the interface is 1.2V CMOS levels. A write operation requires 18 data bits and 18 clock pulses, as shown in Figure 23. The 18 data bits contain the 8-bit register array row data (LSB is clocked in first), followed by the register array row address (ROW0 through ROW15, 000000 to 001111, LSB first), the Read/Write bit (set to 1 to write), and finally the Tx chip address 110, LSB first).

Note that the register array row address is 6 bits, but only four are used to designate 16 rows, the two MSBs are 0.

After the 18th clock pulse of the write operation, the ENABLE line returns high to load the register array on the IC; prior to the rising edge of the ENABLE line, no data is written to the array. The CLK line should have stabilized in the low state at least 2 ns prior to the rising edge of the ENABLE line.

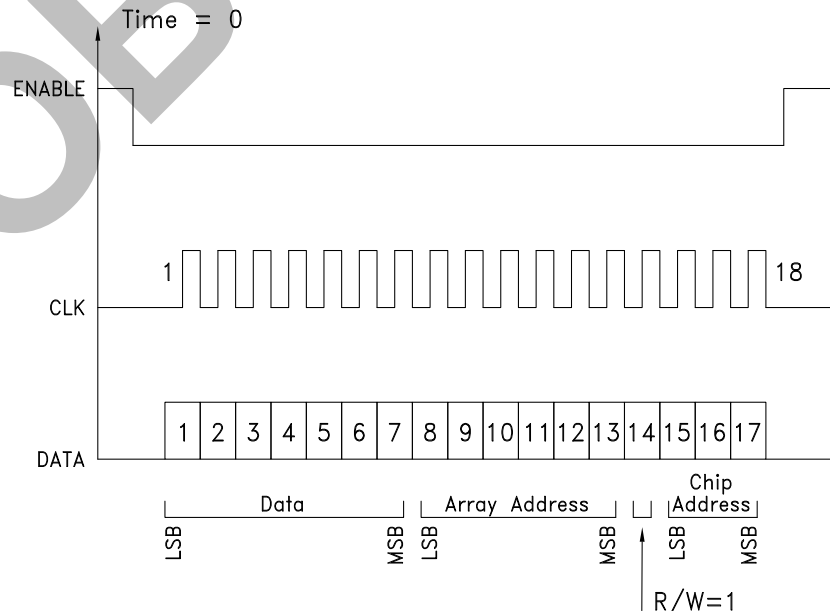

Figure 22. Timing Diagram for writing a row of the Transmitter Serial Interface



MILLIMETERWAVE TRANSMITTER
57 - 64 GHz

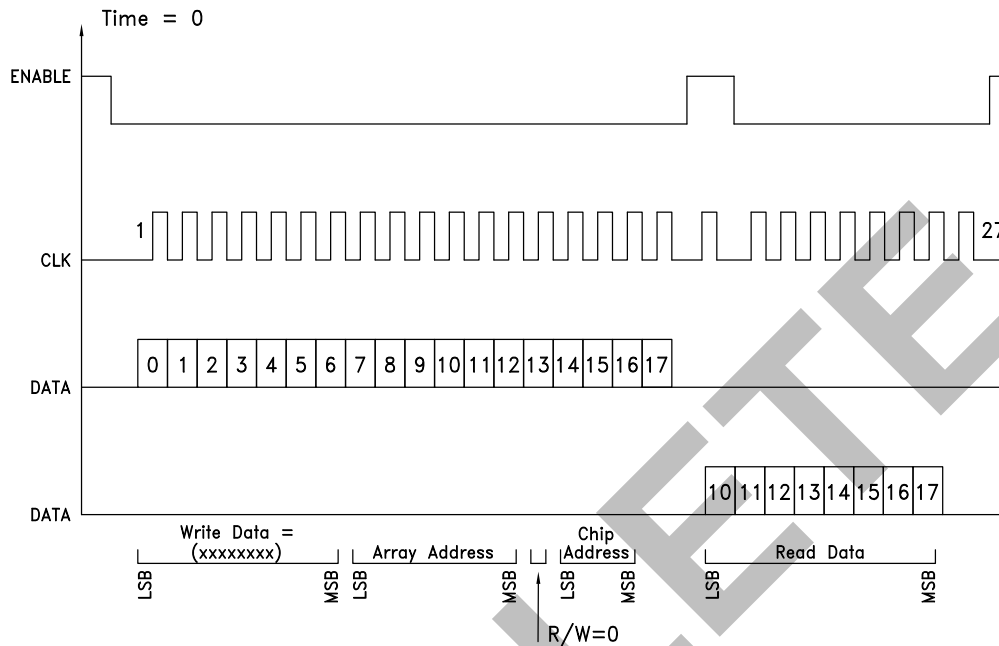

Figure 23. Timing Diagram for reading a row of the Transmitter Serial Interface

Table 8. Transmitter Register Array Assignments

Register Array Row & Bit	Internal Signal Name	Signal Function
ROW0		
ROW0<7>	pa_pwrdn	Active high to power down most other PA circuits not controlled by ROW0<6>
ROW0<6>	pa_pwrdn_fast	Active high to power down the PA core in < 1 μs
ROW0<5>	upmixer_pwrdn	Active high to power down IF to RF upmixer
ROW0<4>	divider_pwrdn	Active high to power down local oscillator divider
ROW0<3>	if_bgmux_pwrdn	Active high to power down one of three on-chip bandgap refs (IF) and associated mux
ROW0<2>	if_upmixer_pwrdn	Active high to power down baseband to IF upmixer
ROW0<1>	driver_pwrdn	Active high to power down PA predriver
ROW0<0>	ifvga_pwrdn	Active high to power down IF variable gain amplifier
ROW1		
ROW1<7>	ipc_pwrdn	Active high to power down on chip current reference generator
ROW1<6>	tripler_pwrdn	Active high to power down frequency tripler
ROW1<5>	ifvga_q_cntrl<2>	These bits control the Q of the IF filter in the baseband to IF upmixer; ROW1<5:3> = 000 for highest Q and highest gain. To reduce Q and widen bandwidth, increment ROW1<5:3> in the sequence
ROW1<4>	ifvga_q_cntrl<1>	
ROW1<3>	ifvga_q_cntrl<0>	
ROW1<2>	not used	ROW1<2:0> = xxx - not used
ROW1<1>	not used	
ROW1<0>	not used	

MILLIMETERWAVE TRANSMITTER
57 - 64 GHz
Table 8. Transmitter Register Array Assignments

Register Array Row & Bit	Internal Signal Name	Signal Function
ROW2		
ROW2<7>	FDB<11>	Factory Diagnostics; ROW2<7:4> = 1111 for normal operation
ROW2<6>	FDB<10>	
ROW2<5>	FDB<9>	
ROW2<4>	FDB<8>	
ROW2<3>	pa_sel_vgbs<3>	Controls the regulator for the base voltage of the PA output transistors; ROW2<3:0> = 0000 for normal operation
ROW2<2>	pa_sel_vgbs<2>	
ROW2<1>	pa_sel_vgbs<1>	
ROW2<0>	pa_sel_vgbs<0>	
ROW3		
ROW3<7>	FDB<7>	Factory Diagnostics; ROW4<7:4> = 0001 for normal operation
ROW3<6>	FDB<6>	
ROW3<5>	FDB<5>	
ROW3<4>	FDB<4>	
ROW3<3>	FDB<3>	Factory Diagnostics; ROW4<3:0> = 1111 for normal operation
ROW3<2>	FDB<2>	
ROW3<1>	FDB<1>	
ROW3<0>	FDB<0>	
ROW4		
ROW4<7>	pa_sel_vref<3>	Controls the bias current for the PA output transistors; ROW4<7:4> = 0011 for normal operation
ROW4<6>	pa_sel_vref<2>	
ROW4<5>	pa_sel_vref<1>	
ROW4<4>	pa_sel_vref<0>	
ROW4<3>	driver_bias<2>	Controls the bias current for the PA predriver; ROW4<3:1> = 111 for normal operation
ROW4<2>	driver_bias<1>	
ROW4<1>	driver_bias<0>	
ROW4<0>	driver_bias2<2>	Controls the bias current for the PA predriver2; ROW4<0> = 1 for normal operation
ROW5		
ROW5<7>	not used	ROW5<7:4> = x - not used
ROW5<6>	not used	
ROW5<5>	not used	
ROW5<4>	not used	
ROW5<3>	bg_monitor_sel	These bits are reserved for diagnostic purposes; ROW5<3:2> = 01 for normal operation
ROW5<2>	if_refsel	
ROW5<1>	enable_fm	Active high to enable the FSK/MSK modulator inputs. ROW5<1> = 0 for normal I/Q operation
ROW5<0>	not used	ROW5<0> = x - not used
ROW6		
ROW6<7>	ifvga_bias<3>	Controls the bias current of the IF variable gain amplifier; ROW6<7:4> = 1000 for normal operation
ROW6<6>	ifvga_bias<2>	
ROW6<5>	ifvga_bias<1>	
ROW6<4>	ifvga_bias<0>	

**MILLIMETERWAVE TRANSMITTER
57 - 64 GHz**
Table 8. Transmitter Register Array Assignments

Register Array Row & Bit	Internal Signal Name	Signal Function
ROW6<3>	ifvga_tune<3>	Controls the tuning of the IF filter for the variable gain amplifier; ROW6<3:0> = 1111 for normal operation
ROW6<2>	ifvga_tune<2>	
ROW6<1>	ifvga_tune<1>	
ROW6<0>	ifvga_tune<0>	
ROW7		
ROW7<7>	ifvga_vga_adj<3>	IF variable gain amplifier gain control bits; ROW7<7:4> = 0000 is highest gain 1101 is lowest gain Attenuation is ≈ 1.3 dB / step, ≈ 17 dB maximum
ROW7<6>	ifvga_vga_adj<2>	
ROW7<5>	ifvga_vga_adj<1>	
ROW7<4>	ifvga_vga_adj<0>	
ROW7<3>	if_upmixer_tune<3>	Controls the tuning of the IF filter for the IF to RF upmixer; ROW7<3:0> = 1111 for normal operation
ROW7<2>	if_upmixer_tune<2>	
ROW7<1>	if_upmixer_tune<1>	
ROW7<0>	if_upmixer_tune<0>	
ROW8		
ROW8<7>	tripler_bias<13>	These bits control the biasing of the frequency tripler; ROW8<7:0> = 10111111 for normal operation
ROW8<6>	tripler_bias<12>	
ROW8<5>	tripler_bias<11>	
ROW8<4>	tripler_bias<10>	
ROW8<3>	tripler_bias<9>	
ROW8<2>	tripler_bias<8>	
ROW8<1>	tripler_bias<7>	
ROW8<0>	tripler_bias<6>	
ROW9		
ROW9<7>	tripler_bias<5>	These bits control the biasing of the frequency tripler; ROW9<7:2> = 011011 for normal operation
ROW9<6>	tripler_bias<4>	
ROW9<5>	tripler_bias<3>	
ROW9<4>	tripler_bias<2>	
ROW9<3>	tripler_bias<1>	
ROW9<2>	tripler_bias<0>	Controls the bias current for the PA predriver2; ROW9<1:0> = 11 for normal operation
ROW9<1>	driver_bias2<1>	
ROW9<0>	driver_bias2<0>	
ROW10		
ROW10<7>	RDACIN<5>	VCO amplitude adjustment DAC; ROW10<7:2> = 111100 for normal operation
ROW10<6>	RDACIN<4>	
ROW10<5>	RDACIN<3>	
ROW10<4>	RDACIN<2>	
ROW10<3>	RDACIN<1>	
ROW10<2>	RDACIN<0>	
ROW10<1>	SYNRESET	ROW10<1> = 0 for normal operation



Table 8. Transmitter Register Array Assignments

Register Array Row & Bit	Internal Signal Name	Signal Function
ROW10<0>	DIVRATIO<4>	ROW10<0> Control the synthesizer divider ratio and output frequency. Refer to Tables 9 and 10 for synthesizer control details.
ROW11		
ROW11<7>	DIVRATIO<3>	ROW11<7:4> Control the synthesizer divider ratio and output frequency. Refer to Tables 9 and 10 for synthesizer control details.
ROW11<6>	DIVRATIO<2>	
ROW11<5>	DIVRATIO<1>	
ROW11<4>	DIVRATIO<0>	
ROW11<3>	BAND<2>	ROW11<3:1> Control the VCO band, and must be changed when tuning the synthesizer output frequency. Refer to Tables 9 and 10 for synthesizer control details.
ROW11<2>	BAND<1>	
ROW11<1>	BAND<0>	
ROW11<0>	REFSELDIV	These bits are reserved for diagnostic purposes; ROW11<0> = 1 for normal operation
ROW12		
ROW12<7>	CPBIAS<2>	These bits control the synthesizer charge pump bias. ROW12<7:5> = 010 for normal operation
ROW12<6>	CPBIAS<1>	
ROW12<5>	CPBIAS<0>	
ROW12<4>	VRSEL<3>	These bits control the width of the lock window for the synthesizer lock detector. ROW12<4:1> = 1111 specifies the widest lock window for normal operation
ROW12<3>	VRSEL<2>	
ROW12<2>	VRSEL<1>	
ROW12<1>	VRSEL<0>	
ROW12<0>	REFSELVCO	This bit is reserved for diagnostic purposes; ROW12<0> = 1 for normal operation
ROW13		
ROW13<7>	MUXREF	These bit are reserved for diagnostic purposes; ROW13<7> = 1 for normal operation
ROW13<6>	DIV4	ROW13<6> = 0 for normal operation
ROW13<5>	ENDC	Active high to enable DC coupling on synthesizer reference input; ROW13<5> = 0 for normal operation
ROW13<4>	INI	This bit is reserved for diagnostic purposes; ROW13<4> = 0 for normal operation
ROW13<3>	PDDIV12	Active high to power down 1.2V circuits in synthesizer divider
ROW13<2>	PDDIV27	Active high to power down 2.7V circuits in synthesizer divider
ROW13<1>	PDQP	Active high to power down synthesizer charge pump
ROW13<0>	PDVCO	Active high to power down synthesizer VCO
ROW14		
ROW14<7>	PDCAL	Active high to power down VCO calibration comparators; ROW14<7> = 0 for normal operation
ROW14<6>	MUXOUT	Controls multiplexing of diagnostic bits, high to read Row15<7:0> ROW14<6> = 1 for normal operation
ROW14<5>	PDALC12	Active high to power down VCO automatic level control (ALC); ROW14<5> = 1 for normal operation
ROW14<4>	PLOAD	Active high to load external amplitude adjustment bits for VCO ROW14<4> = 1 for normal operation

**MILLIMETERWAVE TRANSMITTER
57 - 64 GHz**
Table 8. Transmitter Register Array Assignments

Register Array Row & Bit	Internal Signal Name	Signal Function
ROW14<3>	WIDE<1>	Control bits for VCO ALC loop; ROW14<3:2> = 01 for normal operation
ROW14<2>	WIDE<0>	
ROW14<1>	SLEW<1>	Controls slew rate in sub-integer N divider ROW14<1:0> = 10 for normal operation
ROW14<0>	SLEW<0>	
ROW15		
ROW15<7>	COMPP	Read only bits to indicate synthesizer lock: ROW15<7:6> = 01 indicates that the VCO control voltage is within the lock window and the synthesizer is locked. 11 indicates the VCO control voltage above lock window 00 below lock window 10 is a disallowed state indicating an error
ROW15<6>	COMP N	
ROW15<5>	RDACMSB<2>	These bits are read only and reserved for factory diagnostic purposes.
ROW15<4>	RDACMSB<1>	
ROW15<3>	RDACMSB<0>	
ROW15<2>	RDACMUX<0>	These bits are read only and reserved for factory diagnostic purposes.
ROW15<1>	RDACMUX<1>	
ROW15<0>	RDACMUX<2>	

Synthesizer Settings
Table 9. IEEE Channels Using 308.5714 MHz Reference

Frequency (GHz)	Divider Setting	Typical Band Setting
57.24	10101	001
57.78	10100	001
58.32 (IEEE CH 1)	10011	010
58.86	10010	010
59.40	10001	011
59.94	10000	011
60.48 (IEEE CH 2)	11111	100
61.02	00000	100
61.56	00001	101
62.10	00010	101
62.64 (IEEE CH 3)	00011	110
63.18	00100	110
63.72	00101	111

Divide Ratio settings consist of registers ROW10 bit <0> (MSB) and ROW11 bits <4:7> (4 LSBs)



Table 10. 500 MHz Channels Using 285.7143 MHz Reference

Frequency (GHz)	Divider Setting	Typical Band Setting
57	00001	000
57.5	00010	000
58	00011	001
58.5	00100	001
59	00101	010
59.5	00110	010
60	00111	011
60.5	01000	011
61	01001	100
61.5	01010	100
62	01011	101
62.5	01100	101
63	01101	110
63.5	01110	110
64	01111	111

Divide Ratio settings consist of registers ROW10 bit <0> (MSB) and ROW11 bits <4:7> (4 LSBs)

OBSOLETE