



Typical Applications

The HMC6001LP711E is ideal for:

- WiGig Single Carrier Modulations
- 60 GHz ISM Band Data Transmitter
- Multi-Gbps Data Communications
- High Definition Video Transmission
- RFID

General Description

The HMC6001LP711E is a complete mmWave receiver IC and low profile antenna integrated in a plastic surface mount package. The receiver includes an LNA, image reject filter, RF to IF downconverter, IF filter, I/Q downconverter, and frequency synthesizer. The receiver operates from 57 to 64 GHz with 1.8 GHz modulation bandwidth. An integrated synthesizer provides tuning in 500 or 540 MHz step sizes depending on the choice of external reference clock. Support for a wide variety of modulation formats is provided through a universal analog baseband IQ interface. Together with the HMC6000LP711E, a complete transmit/receive chipset is provided for multi-Gbps operation in the unlicensed 60 GHz ISM band.

Features

- Support for IEEE Channel Plan
- Receiver Gain: 2 - 67 dB
- Noise Figure: 7.0 dB
- Integrated Low Profile Antenna: 7.5 dBi
- Integrated Image Reject Filter
- Integrated Frequency Synthesizer
- Programmable IF and Baseband Gain Blocks
- Universal Analog I/Q Baseband Interface
- Integrated AM and FM Demodulator
- Three-Wire Serial Digital Interface
- 60 Lead 7x11 mm SMT Package: 77mm²

Functional Diagram

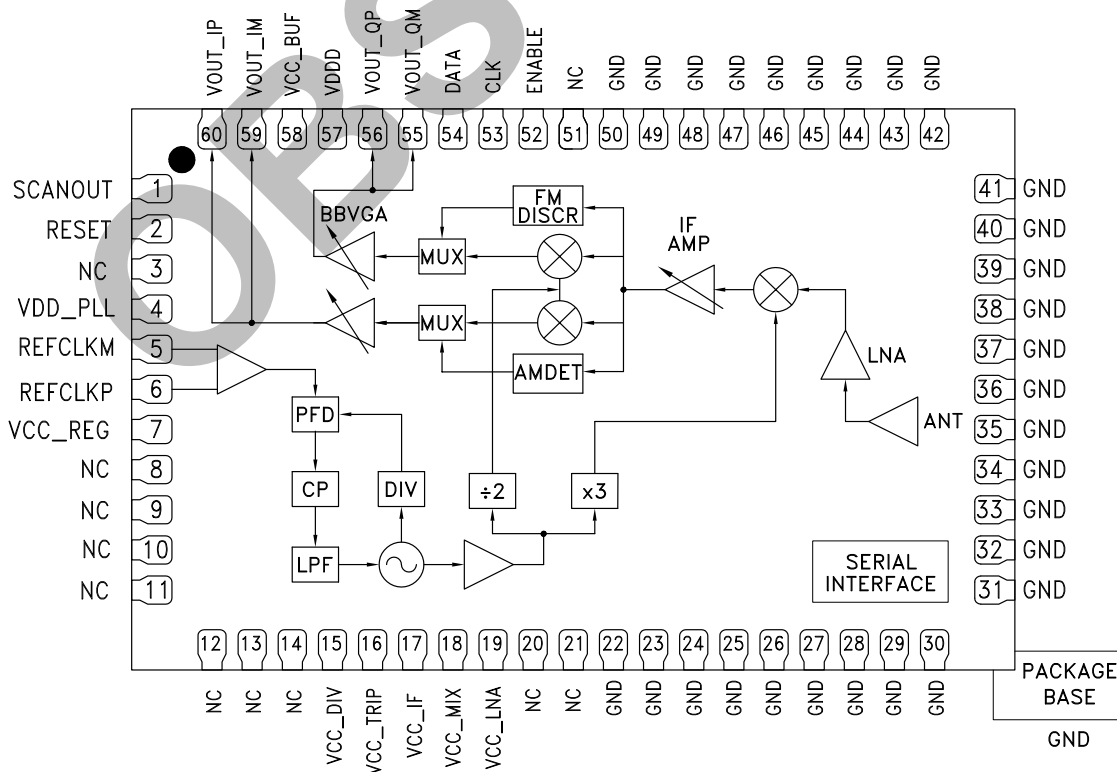

Information furnished by Analog Devices is believed to be accurate and reliable. However, no responsibility is assumed by Analog Devices for its use, nor for any infringements of patents or other rights of third parties that may result from its use. Specifications subject to change without notice. No license is granted by implication or otherwise under any patent or patent rights of Analog Devices. Trademarks and registered trademarks are the property of their respective owners.

For price, delivery, and to place orders: Analog Devices, Inc., One Technology Way, P.O. Box 9106, Norwood, MA 02062-9106
Phone: 781-329-4700 • Order online at www.analog.com
Application Support: Phone: 1-800-ANALOG-D



Table 1. Electrical Specifications, TA = +25° C, See Test Conditions

Parameter	Condition	Min.	Typ.	Max.	Units
Frequency Range		57		64	GHz
Frequency Step Size	308.5714 MHz Ref Clk		0.54		GHz
Frequency Step Size	285.714 MHz Ref Clk		0.50		GHz
Modulation Bandwidth	Max BW setting, 5dB BW, double-sided		1.8		GHz
Max Gain	Total Pout at all 4 baseband outputs minus Pin at the IC [1]		67		dB
Gain Control Range			65		dB
Gain Step Size			1		dB
Antenna Gain	Measured on Evaluation Board		7.5		dBi
Noise Figure	at Max Gain with Antenna [2]		7		dB
Input IP3	Pin at IC [1], set to Min Gain		-27		dBm
Input P1dB	Pin at IC [1], set to Min Gain		-36		dBm
Image Rejection			>35		dB
Sideband Suppression			27		dBc
Phase Noise @ 100 kHz			-72		dBc/Hz
Phase Noise @ 1 MHz			-86		dBc/Hz
Phase Noise @ 10 MHz			-111		dBc/Hz
Phase Noise @ 100 MHz			-125		dBc/Hz
Phase Noise @ 1 GHz			-127		dBc/Hz
PLL Loop BW	Internal Loop Filter		200		kHz
Power Dissipation			0.610		W

[1] Does not include antenna gain.
[2] Specification includes loss contribution due to antenna-in-package.

Table 2. Test Conditions

Reference frequency	308.5714 MHz
Temperature	+25°C
Gain Setting	Max
Input Signal Level	-65 dBm
IF Bandwidth	Max
Input Impedance	50Ω Single-Ended
Output Impedance	100Ω Differential



MILLIMETERWAVE RECEIVER 57 - 64 GHz

Table 3. Recommended Operation Conditions

Description	Symbol	Min	Typical	Max	Units
Analog Ground	GND		0		Vdc
Power Supplies	VCC_BUF VCC_REG VCC_IF VCC_TRIP VCC_DIV VCC_MIX VCC_LNA	2.565	2.7	2.835	Vdc
	VDDD VDD_PLL	1.3	1.35	1.48	Vdc
Input Voltage Ranges					
Serial Digital Interface – Logic High	DATA ENABLE CLK RESET	0.9	1.2	1.4	V
Serial Digital Interface – Logic Low	DATA ENABLE CLK RESET	-0.05	0.1	0.3	V
Reference Clock	REFCLKP REFCLKM		3.3 or 2.5V LVPECL/LVDS 1.2V CMOS		V
Baseband I and Q [1]	VOUT_IM VOUT_IP VOUT_QM VOUT_QP	10	50	200	mVp-p
Baseband I and Q Common Mode			1.3		V
Temperature		-40		+85	C
[1] Baseband voltage at each of the 4 baseband outputs					

Table 4. Power Consumption

Voltage	Typical Current (mA)	Typical Power Consumption (Watts)
VCC_BUF (2.7Vdc)	67	0.60
VCC_REG (2.7Vdc)	13	
VCC_IF (2.7Vdc)	37	
VCC_TRIP (2.7Vdc)	47	
VCC_DIV (2.7Vdc)	34	
VCC_MIX (2.7Vdc)	15	
VCC_LNA (2.7Vdc)	11	
VDDD (1.35Vdc)	1	0.01
VDD_PLL (1.35Vdc)	7	



**MILLIMETERWAVE RECEIVER
57 - 64 GHz**

Figure 1. Antenna Peak Gain vs. Frequency^[1]

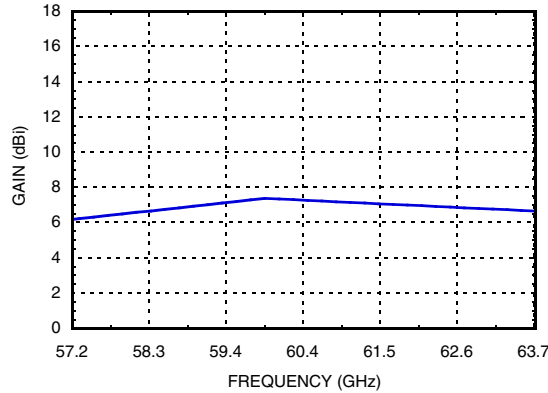

Figure 2. Antenna Gain vs. Angle and Principal Plane Cut^[1]

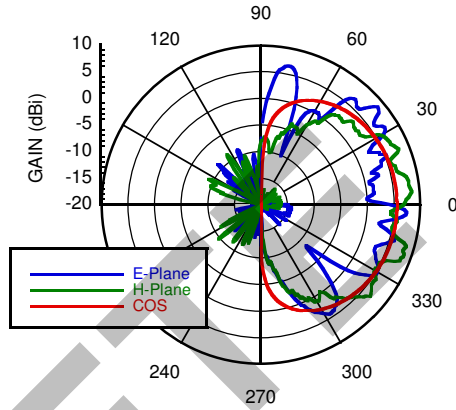

Figure 3. IC Gain vs. Frequency Across Voltage^{[2][3]}

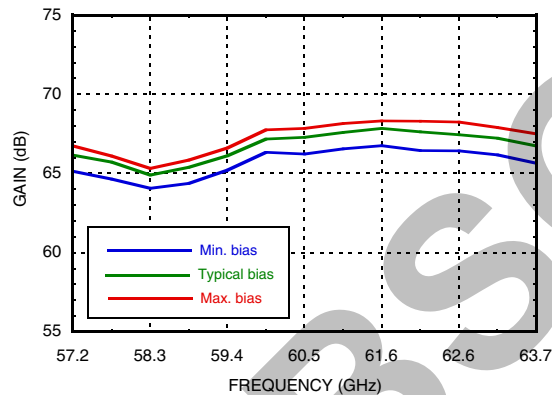

Figure 4. IC Gain vs. Frequency Over Temperature^{[2][3]}

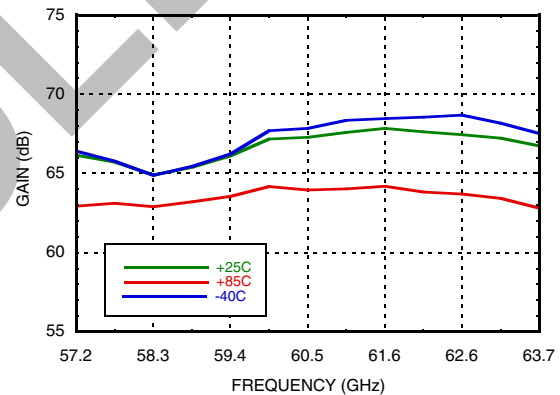

Figure 5. IC Noise Figure vs. Frequency and IF Gain^[3]

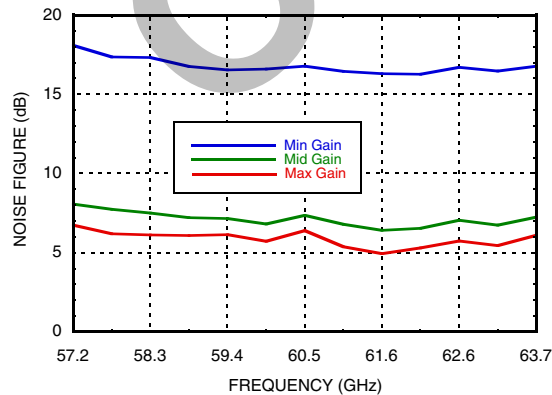
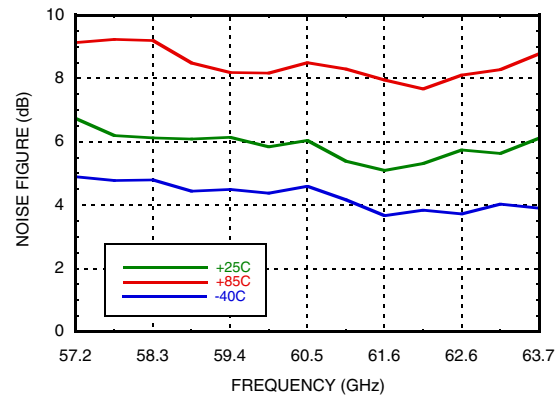

Figure 6. IC Noise Figure vs. Frequency Over Temperature^{[2][3]}



[1] Antenna patterns and gain are measured on packages mounted on the Evaluation PCB Daughtercards (see p.10).

[2] Specified at maximum gain setting.

[3] Measured without antenna gain.



**MILLIMETERWAVE RECEIVER
57 - 64 GHz**

Figure 7. IC Noise Figure vs. Frequency Across Voltage^{[2][3]}

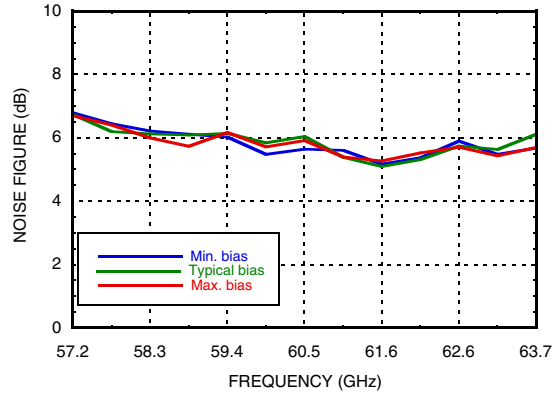

Figure 8. Input P1dB vs. Frequency Across Voltage^{[3][4]}

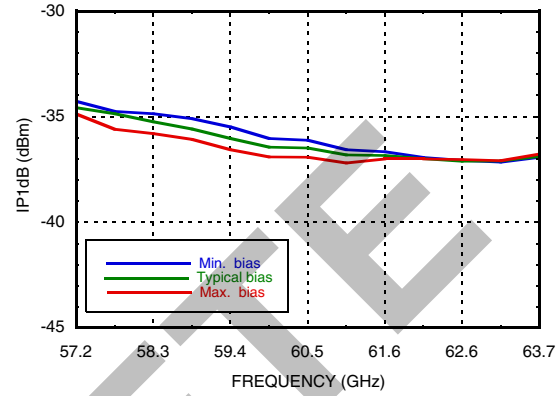

Figure 9. Input P1dB vs. Frequency Over Temperature^{[3][4]}

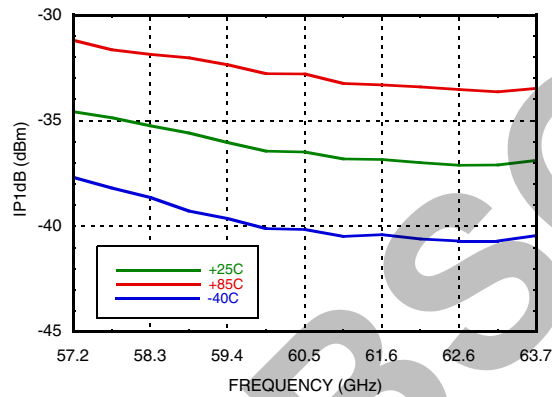

Figure 10. Input IP1dB vs. Frequency and Gain^[3]

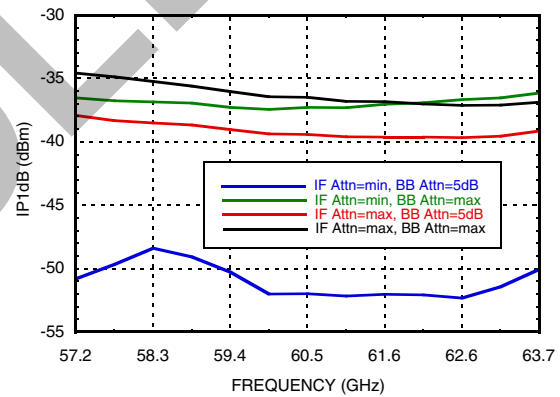

Figure 11. Input IP3 vs. Frequency Across Voltage^{[3][4]}

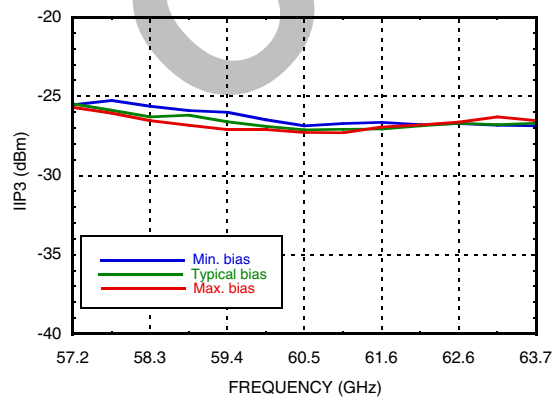
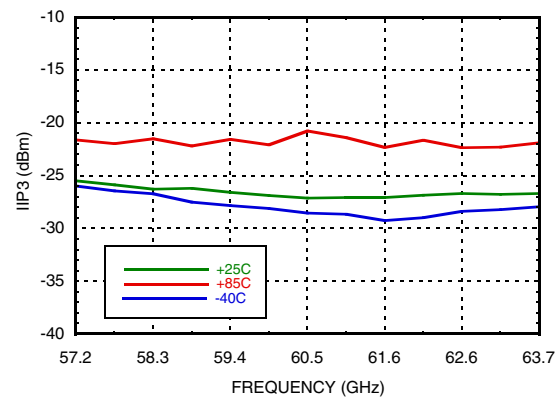

Figure 12. Input IP3 vs. Frequency Over Temperature^{[3][4]}



[2] Specified at maximum gain setting,
 [3] Measured without antenna gain.
 [4] Specified at minimum gain setting,



**MILLIMETERWAVE RECEIVER
57 - 64 GHz**

Figure 13. Input IP3 vs. Frequency and Gain^[3]

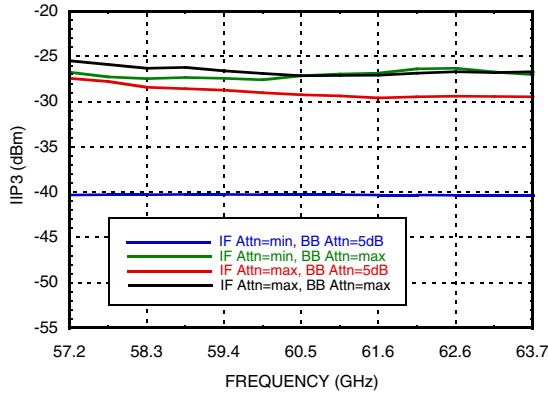

Figure 14. Baseband Attenuation Over Temperature

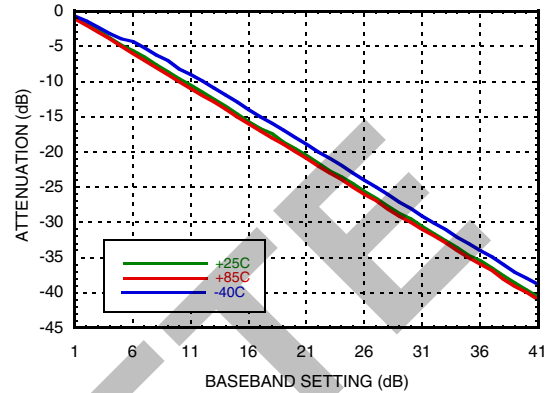

Figure 15. IF Attenuation vs. Attenuator Setting vs Frequency

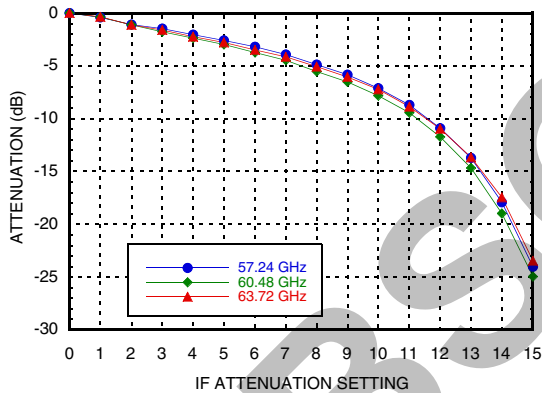

Figure 16. IF Attenuation vs. Attenuator Setting over Temperature^[5]

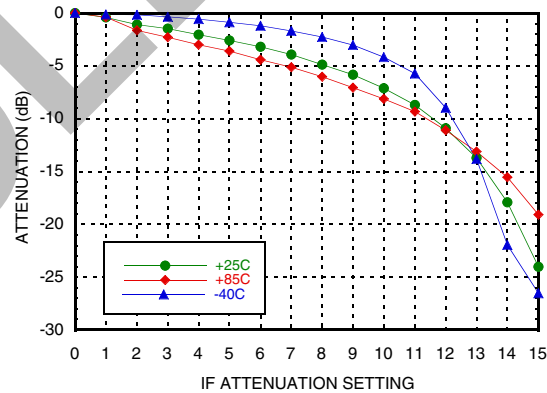

Figure 17. Single Sided Passband Response vs. Voltage^{[5][6]}

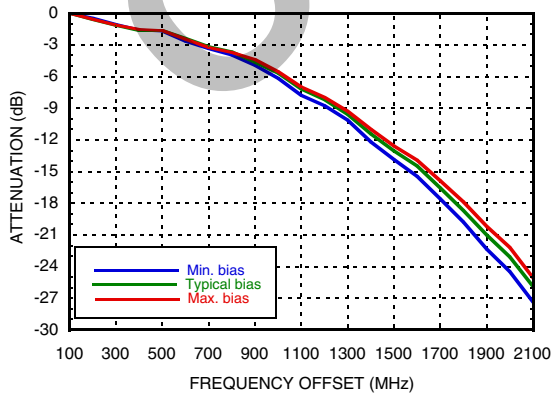
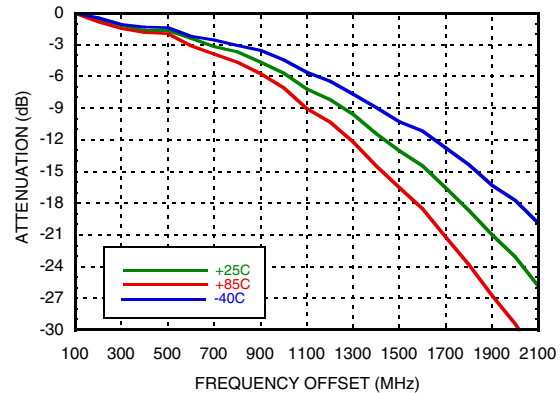

Figure 18. Single Sided Passband Response vs. Temperature^{[5][6]}



[3] Measured without antenna gain.
[5] Measured with a 60.48 GHz carrier.
[6] Specified at maximum BW setting.



**MILLIMETERWAVE RECEIVER
57 - 64 GHz**

Figure 19. Single Sided Passband Response vs. IF Gain^{[5][6]}

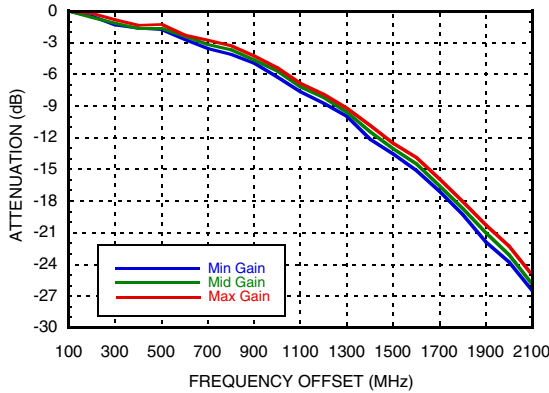

Figure 20. Single Sided Passband Response vs. Frequency^[6]

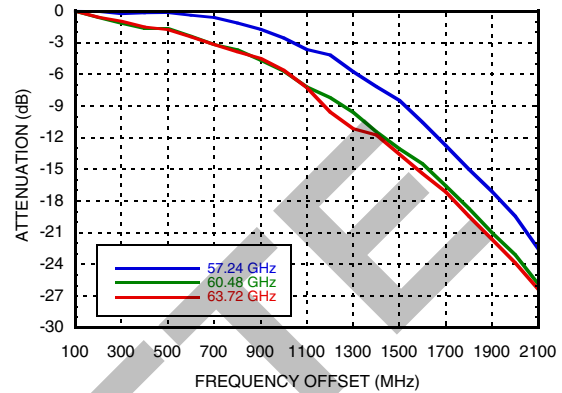

Figure 21. Single Sided Passband Response BW vs. BW Setting^[5]

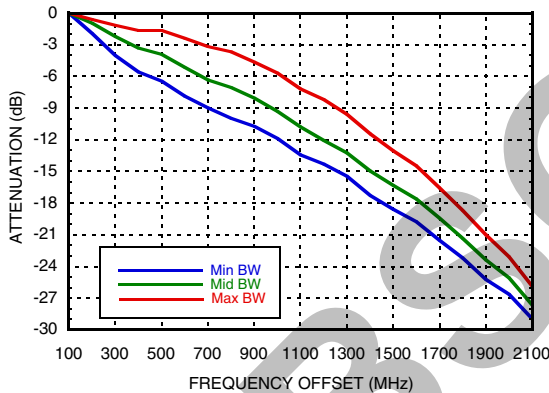

Figure 22. Sideband Suppression vs. Frequency across Voltage^[2]

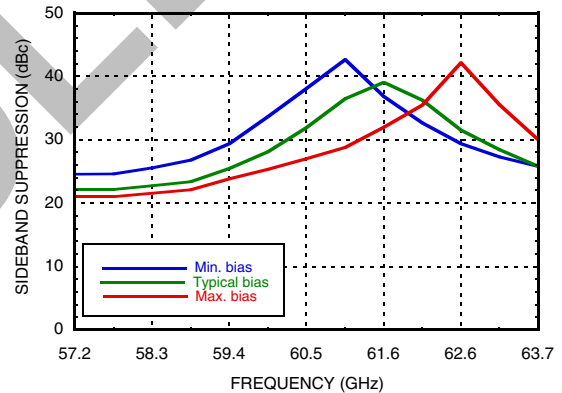

Figure 23. Sideband Suppression vs. Frequency over Temperature^[2]

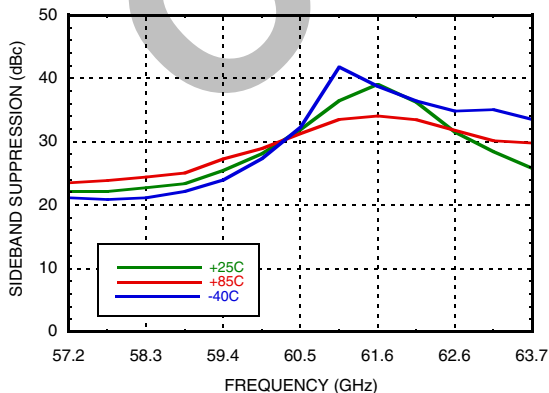
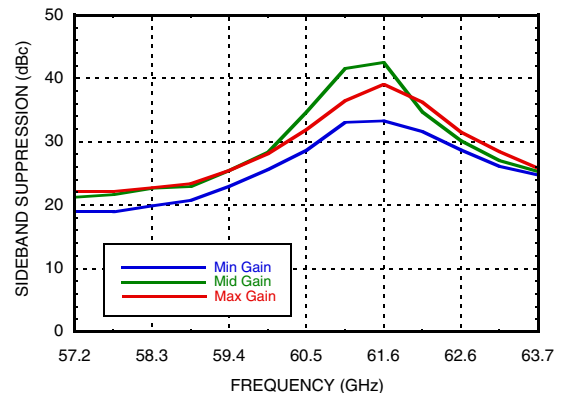

Figure 24. Sideband Suppression vs. Frequency and IF Gain



[2] Specified at maximum gain setting.
[5] Measured with a 60.48 GHz carrier.
[6] Specified at maximum BW setting.

MILLIMETERWAVE RECEIVER 57 - 64 GHz

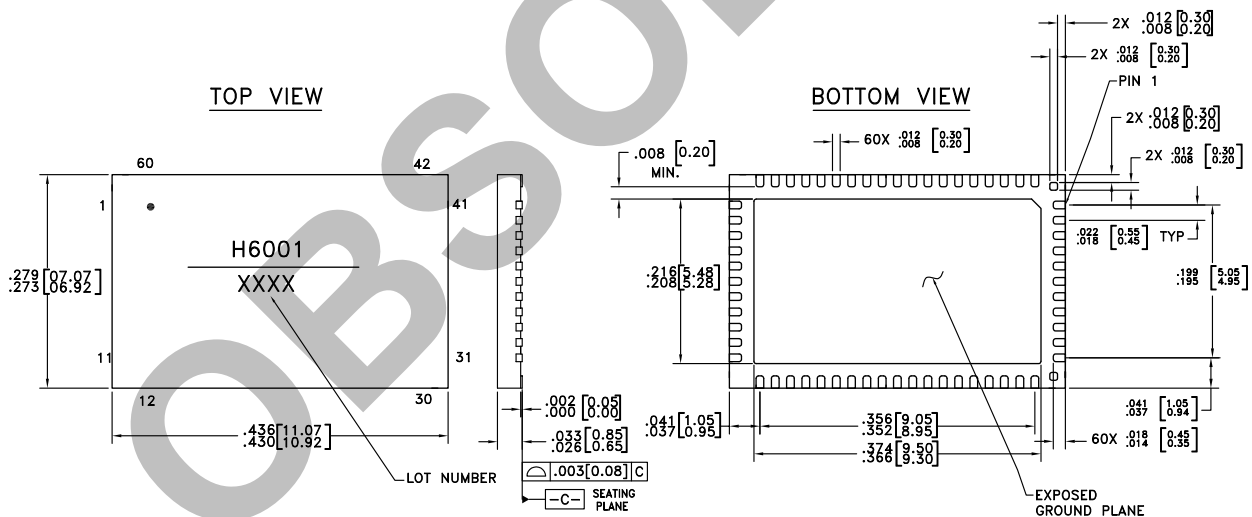

Table 5. Absolute Maximum Ratings

Input Power to IC	0 dBm
VDD = 2.7 V	2.85 Vdc
VCC = 2.7 V	2.85 Vdc
VDD_PLL = 1.35 V	1.6 Vdc
VDDD = 1.35 V	1.6 Vdc
GND	0± 50 mV
Serial Digital Interface Input Voltage	1.5 Vdc
Ref CLK Input (AC coupled)(each)	0.75 Vp-p
Baseband Outputs (BB, FM)	0.75 Vp-p
Junction Temperature	125°C
Continuous P _{diss} (T=85°C) (derate 45 mW/°C above 85°C)	0.760 W
Thermal Resistance (R _{th}) (Junction to ground paddle)	22.16 °C/W
Storage Temperature	-55°C to 150°C
Operating Temperature	-40°C to 85°C
ESD Sensitivity (HBM)	Class 1A

Stresses above those listed under Absolute Maximum Ratings may cause permanent damage to the device. This is a stress rating only; functional operation of the device at these or any other conditions above those indicated in the operational section of this specification is not implied. Exposure to absolute maximum rating conditions for extended periods may affect device reliability.

Outline Drawing



NOTES:

1. ALL DIMENSIONS ARE IN INCHES [MM]
2. LEAD SPACING TOLERANCE IS NON-CUMULATIVE.
3. PAD BURR LENGTH SHALL BE 0.15 mm MAX. PAD BURR HEIGHT SHALL BE 0.05 mm MAX.
4. PACKAGE WARP SHALL NOT EXCEED 0.05 mm
5. ALL GROUND LEADS AND GROUND PADDLE MUST BE SOLDERED TO PCB RF GROUND
6. REFER TO HITTITE APPLICATION NOTE FOR SUGGESTED PCB LAND PATTERN.

Table 6. Package Information

Part Number	Package Body Material	Lead Finish	MSL Rating	Package Marking
HMC6001LP711E	RoHS-compliant Low Stress Injection Molded Plastic Silica and Silicon	100% matte Sn	MSL3	H6001 XXXX

[1] 4-Digit lot number XXXX

**MILLIMETERWAVE RECEIVER
57 - 64 GHz**
Table 7. Pin Descriptions

Pin Number	Function	Description
1	SCANOUT	Serial digital interface out (1.2V CMOS) - 50k Ω
2	RESET	Asynchronous reset-all registers (1.2V CMOS, active high) - 50k Ω
3, 8-14, 20, 21, 51	NC	These pins are not connected internally
4	VDD_PLL	1.35V supply (VCO)
5	REFCLKM	Xtal REF CLK Minus - AC or DC coupled - 50 Ω
6	REFCLKP	Xtal REF CLK Minus - AC or DC coupled - 50 Ω
7	VCC_REG	2.7V supply (VCO)
15	VCC_DIV	2.7V supply (Divider)
16	VCC_TRIP	2.7V supply (Tripler)
17	VCC_IF	2.7V supply (IF)
18	VCC_MIX	2.7V supply (Mixer)
19	VCC_LNA	2.7V supply (LNA)
22-50	GND	These pins and package bottom must be connected to RF/DC ground externally.
52	ENABLE	Serial digital interface enable (1.2V CMOS) - 50k Ω
53	CLK	Serial digital interface clock (1.2V CMOS) - 50k Ω
54	DATA	Serial digital interface data (1.2V CMOS) - 50k Ω
55	VOUT_QM	Baseband negative quadrature output – DC coupled - 50 Ω (1.3V c.m.)
56	VOUT_QP	Baseband positive quadrature output – DC coupled - 50 Ω (1.3V c.m.)
57	VDDD	1.35V supply (serial data interface)
58	VCC_BUF	2.7V supply (BB VGA and output buffers)
59	VOUT_IM	Baseband negative in-phase output – DC coupled - 50 Ω (1.3V c.m.)
60	VOUT_IP	Baseband positive in-phase output – DC coupled - 50 Ω (1.3V c.m.)

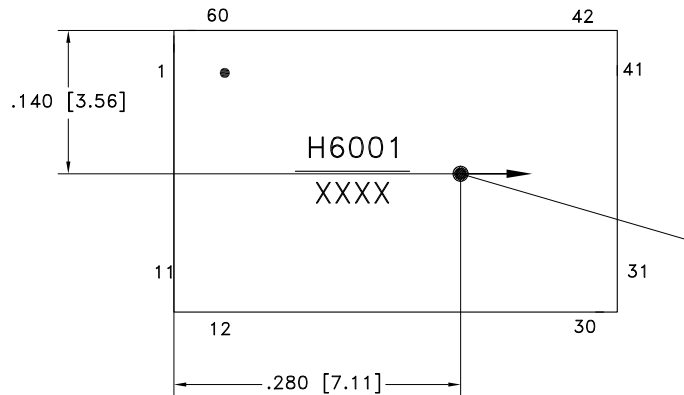
Antenna-in-Package Location and Polarization

 ANTENNA CENTER
LOCATION
& POLARIZATION

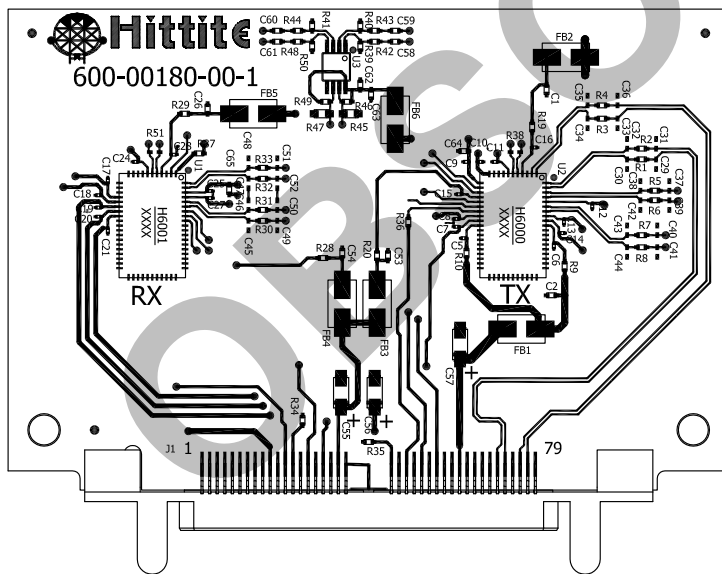
The antenna is located inside the package with geometric center and linear polarization angle as shown. The geometric center can be used as the antenna pattern phase center provided there is sufficient unobstructed ground plane extension around the chip. Measured antenna pattern phase centers will vary with frequency and are dependent on finite ground plane effects, and coupling to nearby components.

Evaluation PCB Daughtercard

The circuit board used in the application should use RF circuit design techniques. Signal lines should have 50 Ohm impedance while the package ground leads and exposed paddle should be connected directly to the ground plane similar to that shown. A sufficient number of via holes should be used to connect the top and bottom ground planes. The evaluation circuit board shown is part of an evaluation kit available from Hittite.



Evaluation PCB Motherboard

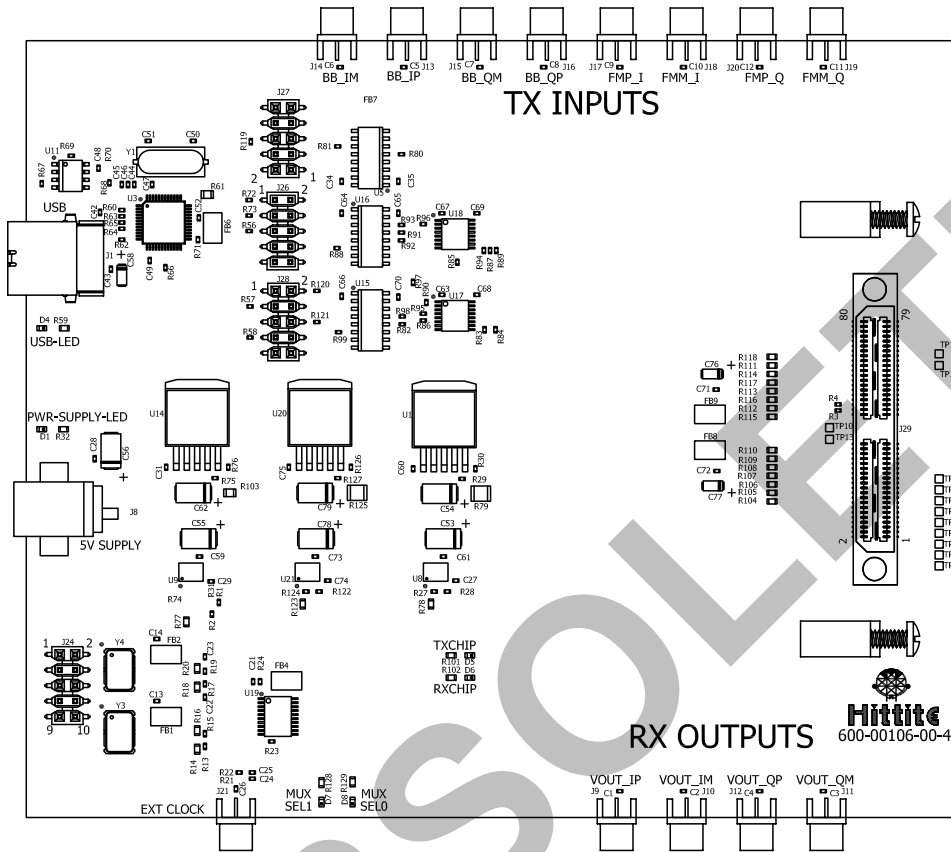

Evaluation PCB Schematics

To view the Evaluation PCB Schematics please visit www.hittite.com and choose HMC6001LP711E from the "Search by Part Number" pull down menu to view the product splash page.

Evaluation Kit

The HMC6450 evaluation kit contains everything that is needed to set up a bi-directional 60 GHz millimeter-wave link using standard RF cable interfaces for baseband input and output. Kit comes with two motherboard PCBs that provide on board crystals, USB interface, supply regulators, and SMA cables for connectorized IQ interfaces. Supplied software allows the user to read from and write to all chip level registers using a Graphical User Interface (GUI) or upload previously saved register settings.

Evaluation Kit Order Information

Item	Contents	Part Number
Evaluation Kit	2 Daughtercard Evaluation PCBs with HMC6001LP711E and HMC6000LP711E 2 Motherboard Evaluation PCBs with crystals, USB Interface, supply regulators and MCX connectorized IQ interface. 2 Wall mount power supplies. 2 USB A Male to USB B Female Cable 8 Phase matched MCX to SMA Cables CD ROM (Contains User Manual, Evaluation PCB Schematic, Evaluation Software)	HMC6450



**MILLIMETERWAVE RECEIVER
57 - 64 GHz**

Theory of Operation

An integrated frequency synthesizer creates a low-phase noise LO between 16.3 and 18.3 GHz. The step size of the synthesizer equates to 540MHz steps at RF when used with 308.5714 MHz reference crystal (compatible with the IEEE channels of the ISM band) or 500 MHz steps if used with a 285.714 MHz reference crystal.

A 57 to 64 GHz signal is received by an integrated low profile antenna which is connected to the single-ended LNA on the IC. The LO is multiplied by three and mixed with the LNA output to downconvert to an 8 to 9.1 GHz sliding IF. An integrated notch filter removes the image frequency. The IF signal is filtered and amplified with 17 dB of variable gain. If the chip is configured for IQ baseband output, the IF signal is fed into a quadrature demodulator using the LO/2 to downconvert to baseband. There are also options to use on-chip demodulators capable of to demodulating AM/FM/FSK/MSK waveforms. Contact Hittite application support for further guidance and application notes if interested in these modes.

The phase noise and quadrature balance of the HMC6001LP711E is sufficient to demodulate up to 16QAM modulation for high data rate operation.

There are no special power sequencing requirements for the HMC6001LP711E; all voltages are to be applied simultaneously.

Register Array Assignments and Serial Interface

The register arrays for both the receiver and transmitter are organized into 16 rows of 8 bits. Using the serial interface, the arrays are written or read one row at a time as shown in Figure 25 and Figure 26, respectively. Figure 25 shows the sequence of signals on the ENABLE, CLK, and DATA lines to write one 8-bit row of the register array. The ENABLE line goes low, the first of 18 data bits (bit 0) is placed on the DATA line, and 2 ns or more after the DATA line stabilizes, the CLK line goes high to clock in data bit 0. The DATA line should remain stable for at least 2 ns after the rising edge of CLK.

The Rx IC will support a serial interface running up to several hundred MHz, and the interface is 1.2V CMOS levels. A write operation requires 18 data bits and 18 clock pulses, as shown in Figure 26. The 18 data bits contain the 8-bit register array row data (LSB is clocked in first), followed by the register array row address (ROW0 through ROW15, 000000 to 001111, LSB first), the Read/Write bit (set to 1 to write), and finally the Rx chip address 111, LSB first).

Note that the register array row address is 6 bits, but only four are used to designate 16 rows, the two MSBs are 0.

After the 18th clock pulse of the write operation, the ENABLE line returns high to load the register array on the IC; prior to the rising edge of the ENABLE line, no data is written to the array. The CLK line should have stabilized in the low state at least 2 ns prior to the rising edge of the ENABLE line.

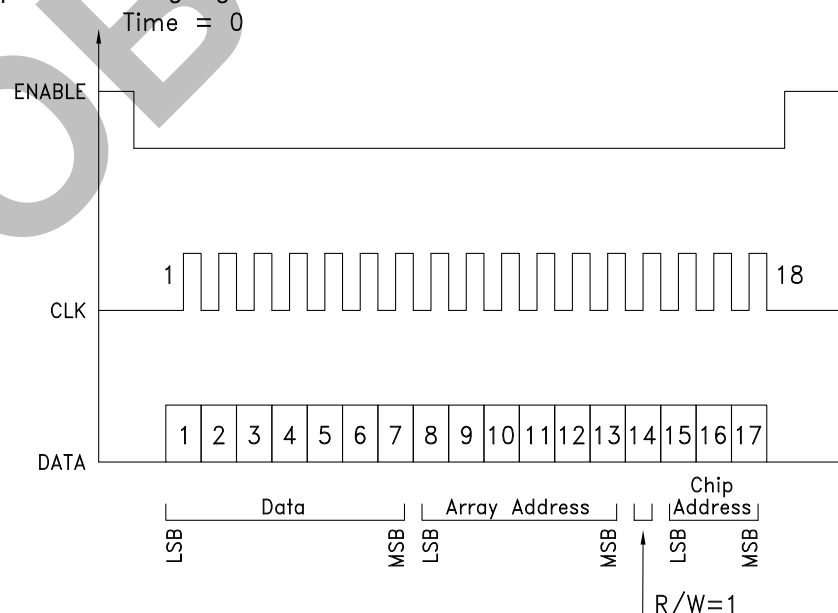

Figure 25. Timing Diagram for writing a row of the Receiver Serial Interface

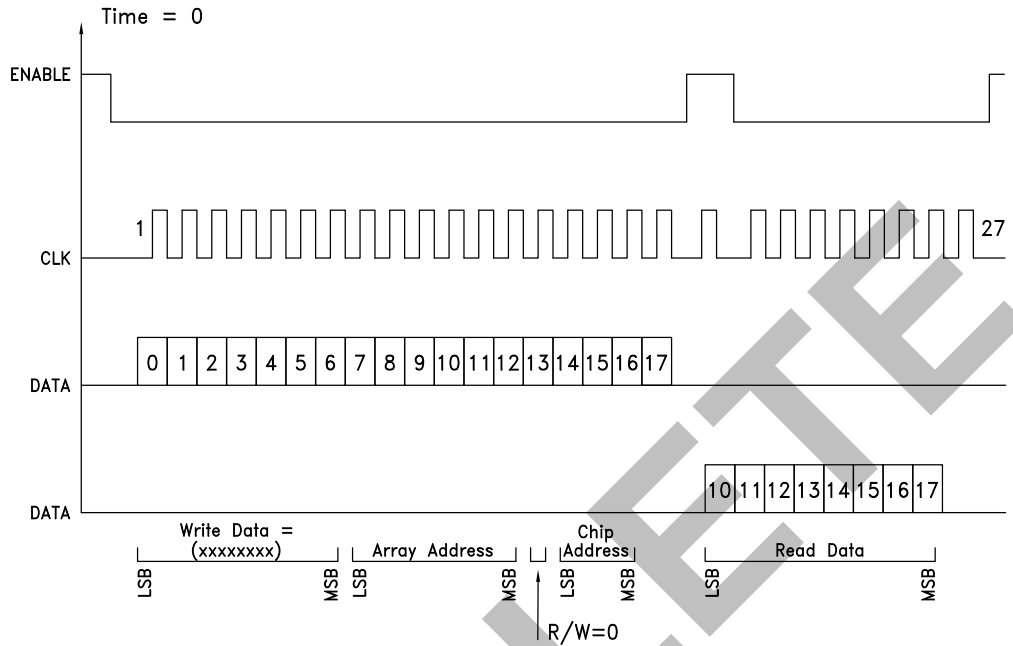

Figure 26. Timing Diagram for reading a row of the Receiver Serial Interface

Table 8. Receiver Register Array Assignments

Register Array Row & Bit	Internal Signal Name	Signal Function
ROW0		
ROW0<7>	ask_pwrdn	Active high to power down ASK demodulator
ROW0<6>	bbamp_pwrdn_i	Active high to power down I-channel baseband amplifier
ROW0<5>	bbamp_pwrdn_q	Active high to power down Q-channel baseband amplifier
ROW0<4>	divider_pwrdn	Active high to power down local oscillator divider
ROW0<3>	if_bgmux_pwrdn	Active high to power down one of three on-chip bandgap refs (IF) and associated mux
ROW0<2>	ifmix_pwrdn_i	Active high to power down I-channel IF to baseband mixer
ROW0<1>	ifmix_pwrdn_q	Active high to power down Q-channel IF to baseband mixer
ROW0<0>	ifvga_pwrdn	Active high to power down IF variable gain amplifier
ROW1		
ROW1<7>	ipc_pwrdn	Active high to power down on chip current reference generator
ROW1<6>	lna_pwrdn	Active high to power down low noise amplifier and reference
ROW1<5>	rfmix_pwrdn	Active high to power down RF to IF mixer
ROW1<4>	tripler_pwrdn	Active high to power down frequency tripler
ROW1<3>	bbamp_atten1_0	First baseband attenuator; ROW1<2:3> = 11 is 18 dB attenuation 10 is 12 dB attenuation 01 is 6 dB attenuation 00 is 0 dB attenuation
ROW1<2>	bbamp_atten1_1	



Table 8. Receiver Register Array Assignments

Register Array Row & Bit	Internal Signal Name	Signal Function
ROW1<1>	bbamp_atten2_0	Second baseband attenuator; ROW1<0:1> = 11 is 18 dB attenuation 10 is 12 dB attenuation 01 is 6 dB attenuation 00 is 0 dB attenuation
ROW1<0>	bbamp_atten2_1	
ROW2		
ROW2<7>	bbamp_attenfi_0	I Channel baseband fine attenuator; ROW2<5:7> ≥ 101 is 5 dB attenuation 100 is 4 dB attenuation 011 is 3 dB attenuation 010 is 2 dB attenuation 001 is 1 dB attenuation 000 is 0 dB attenuation
ROW2<6>	bbamp_attenfi_1	
ROW2<5>	bbamp_attenfi_2	
ROW2<4>	bbamp_attenfq_0	Q Channel baseband fine attenuator; ROW2<2:4> ≥ 101 is 5 dB attenuation 100 is 4 dB attenuation 011 is 3 dB attenuation 010 is 2 dB attenuation 001 is 1 dB attenuation 000 is 0 dB attenuation
ROW2<3>	bbamp_attenfq_1	
ROW2<2>	bbamp_attenfq_2	
ROW2<1>	bbamp_selask	Active high to multiplex the AM detector output into the I channel baseband amplifier input
ROW2<0>	bbamp_sigshort	Active high to short the input to the I and Q channel baseband amplifiers
ROW3		
ROW3<7>	bbamp_selbw0	Selects the low pass corner of the baseband amplifiers; ROW3<6:7> = 00 is ≈ 1.4 GHz 01 is ≈ 500 MHz 10 is ≈ 300 MHz 11 is ≈ 200 MHz
ROW3<6>	bbamp_selbw1	
ROW3<5>	bbamp_selfastrec	Selects the high pass corner of the baseband amplifiers; ROW3<4:5> = 00 is ≈ 30 kHz 01 is ≈ 300 kHz 10 is ≈ 1.5 MHz
ROW3<4>	bbamp_selfastrec2	
ROW3<3>	bg_monitor_sel<1>	These bits are for reserved for diagnostic purposes; ROW3<3:0> = 0011 for normal operation
ROW3<2>	bg_monitor_sel<0>	
ROW3<1>	if_refsel	
ROW3<0>	lna_refsel	
ROW4		



Table 8. Receiver Register Array Assignments

Register Array Row & Bit	Internal Signal Name	Signal Function
ROW4<7>	ifvga_bias<2>	These bits are for biasing and IF filter alignment in the IF variable gain amplifier; ROW4<7:0> = 1001111x for normal operation
ROW4<6>	ifvga_bias<1>	
ROW4<5>	ifvga_bias<0>	
ROW4<4>	ifvga_tune<4>	
ROW4<3>	ifvga_tune<3>	
ROW4<2>	ifvga_tune<2>	
ROW4<1>	ifvga_tune<1>	
ROW4<0>	not used	
ROW5		
ROW5<7>	ifvga_vga_adj<3>	IF variable gain amplifier gain control bits; ROW5<7:4> = 0000 is highest gain 1111 is lowest gain Attenuation is ≈ 1 dB / step, ≈ 20 dB maximum
ROW5<6>	ifvga_vga_adj<2>	
ROW5<5>	ifvga_vga_adj<1>	
ROW5<4>	ifvga_vga_adj<0>	
ROW5<3>	rfmix_tune<4>	These bits control IF filter alignment in the RF mixer; ROW5<3:0> = 1111 for normal operation
ROW5<2>	rfmix_tune<3>	
ROW5<1>	rfmix_tune<2>	
ROW5<0>	rfmix_tune<1>	
ROW6		
ROW6<7>	tripler_bias<13>	These bits control the biasing of the frequency tripler; ROW6<7:0> = 10111111 for normal operation
ROW6<6>	tripler_bias<12>	
ROW6<5>	tripler_bias<11>	
ROW6<4>	tripler_bias<10>	
ROW6<3>	tripler_bias<9>	
ROW6<2>	tripler_bias<8>	
ROW6<1>	tripler_bias<7>	
ROW6<0>	tripler_bias<6>	
ROW7		
ROW7<7>	tripler_bias<5>	These bits control the biasing of the frequency tripler; ROW7<7:2> = 011011 for normal operation
ROW7<6>	tripler_bias<4>	
ROW7<5>	tripler_bias<3>	
ROW7<4>	tripler_bias<2>	
ROW7<3>	tripler_bias<1>	
ROW7<2>	tripler_bias<0>	
ROW7<1>	bbamp_selfm	Active high to multiplex the FM detector output into the Q channel baseband amplifier input
ROW7<0>	fm_pwrn	Active high to power down FM demodulator
ROW8		
ROW8<7>	lna_bias<2>	These bits control biasing of the low noise amplifier; ROW8<7:5> = 100 for normal operation
ROW8<6>	lna_bias<1>	
ROW8<5>	lna_bias<0>	



Table 8. Receiver Register Array Assignments

Register Array Row & Bit	Internal Signal Name	Signal Function
ROW8<4>	not used	ROW8<4:3> = xx - not used
ROW8<3>	not used	
ROW8<2>	ifvga_q_cntrl<2>	These bits control the Q of the IF filter in the IF variable gain amplifier; ROW8<2:0> = 000 for highest Q and highest gain. To reduce Q and widen bandwidth, increment ROW8<2:0> in the sequence: 001 100 101 111
ROW8<1>	ifvga_q_cntrl<1>	
ROW8<0>	ifvga_q_cntrl<0>	
ROW9		
ROW9<7>	not used	ROW9<7:0> = xxxxxxxx - not used
ROW9<6>	not used	
ROW9<5>	not used	
ROW9<4>	not used	
ROW9<3>	not used	
ROW9<2>	not used	
ROW9<1>	not used	
ROW9<0>	not used	
ROW10		
ROW10<7>	RDACIN<5>	VCO amplitude adjustment DAC; ROW10<7:2> = 111100 for normal operation
ROW10<6>	RDACIN<4>	
ROW10<5>	RDACIN<3>	
ROW10<4>	RDACIN<2>	
ROW10<3>	RDACIN<1>	
ROW10<2>	RDACIN<0>	
ROW10<1>	SYNRESET	ROW10<1> = 0 for normal operation
ROW10<0>	DIVRATIO<4>	ROW10<0> Control the synthesizer divider ratio and output frequency. Refer to Tables 9 and 10 for synthesizer control details
ROW11		
ROW11<7>	DIVRATIO<3>	ROW11<7:4> Control the synthesizer divider ratio and output frequency. Refer to Tables 9 and 10 for synthesizer control details.
ROW11<6>	DIVRATIO<2>	
ROW11<5>	DIVRATIO<1>	
ROW11<4>	DIVRATIO<0>	
ROW11<3>	BAND<2>	ROW11<3:1> Control the VCO band, and must be changed when tuning the synthesizer output frequency. Refer to Tables 9 and 10 for synthesizer control details.
ROW11<2>	BAND<1>	
ROW11<1>	BAND<0>	
ROW11<0>	REFSELDIV	These bits are reserved for diagnostic purposes; ROW11<0> = 1 for normal operation
ROW12		
ROW12<7>	CPBIAS<2>	These bits control the synthesizer charge pump bias. ROW12<7:5> = 010 for normal operation
ROW12<6>	CPBIAS<1>	
ROW12<5>	CPBIAS<0>	



Table 8. Receiver Register Array Assignments

Register Array Row & Bit	Internal Signal Name	Signal Function
ROW12<4>	VRSEL<3>	These bits control the width of the lock window for the synthesizer lock detector. ROW12<4:1> = 1111 specifies the widest lock window for normal operation
ROW12<3>	VRSEL<2>	
ROW12<2>	VRSEL<1>	
ROW12<1>	VRSEL<0>	
ROW12<0>	REFSELVCO	This bit is reserved for diagnostic purposes; ROW12<0> = 1 for normal operation
ROW13		
ROW13<7>	MUXREF	This bit is reserved for diagnostic purposes; ROW13<7> = 1 for normal operation
ROW13<6>	DIV4	ROW13<6> = 0 for normal operation
ROW13<5>	ENDC	Active high to enable DC coupling on synthesizer reference input; ROW13<5> = 0 for normal operation
ROW13<4>	INI	This bit is reserved for diagnostic purposes; ROW13<4> = 0 for normal operation
ROW13<3>	PDDIV12	Active high to power down 1.2V circuits in synthesizer divider
ROW13<2>	PDDIV27	Active high to power down 2.7V circuits in synthesizer divider
ROW13<1>	PDQP	Active high to power down synthesizer charge pump
ROW13<0>	PDVCO	Active high to power down synthesizer VCO
ROW14		
ROW14<7>	PDCAL	Active high to power down VCO calibration comparators; ROW14<7> = 0 for normal operation
ROW14<6>	MUXOUT	Controls multiplexing of diagnostic bits, high to read Row15<7:0> ROW14<6> = 1 for normal operation
ROW14<5>	PDALC12	Active high to power down VCO automatic level control (ALC); ROW14<5> = 1 for normal operation
ROW14<4>	PLoad	Active high to load external amplitude adjustment bits for VCO ROW14<4> = 1 for normal operation
ROW14<3>	WIDE<1>	Control bits for VCO ALC loop; ROW14<3:2> = 01 for normal operation
ROW14<2>	WIDE<0>	
ROW14<1>	SLEW<1>	Controls slew rate in sub-integer N divider ROW14<1:0> = 10 for normal operation
ROW14<0>	SLEW<0>	
ROW15		
ROW15<7>	COMPP	Read only bits to indicate synthesizer lock: ROW15<7:6> = 01 indicates that the VCO control voltage is within the lock window and the synthesizer is locked. 11 indicates the VCO control voltage above lock window 00 below lock window 10 is a disallowed state indicating an error
ROW15<6>	COMPn	
ROW15<5>	RDACMSB<2>	These bits are read only and reserved for factory diagnostic purposes.
ROW15<4>	RDACMSB<1>	
ROW15<3>	RDACMSB<0>	
ROW15<2>	RDACMUX<0>	These bits are read only and reserved for factory diagnostic purposes.
ROW15<1>	RDACMUX<1>	
ROW15<0>	RDACMUX<2>	



Synthesizer Settings

Table 9. IEEE Channels Using 308.5714 MHz Reference

Frequency (GHz)	Divider Setting	Typical Band Setting
57.24	10101	001
57.78	10100	001
58.32 (IEEE CH 1)	10011	010
58.86	10010	010
59.40	10001	011
59.94	10000	011
60.48 (IEEE CH 2)	11111	100
61.02	00000	100
61.56	00001	101
62.10	00010	101
62.64 (IEEE CH 3)	00011	110
63.18	00100	110
63.72	00101	111

Divide Ratio settings consist of registers ROW10 bit <0> (MSB) and ROW11 bits <4:7> (4 LSBs)

Table 10. 500 MHz Channels Using 285.7143 MHz Reference

Frequency (GHz)	Divider Setting	Typical Band Setting
57	00001	000
57.5	00010	000
58	00011	001
58.5	00100	001
59	00101	010
59.5	00110	010
60	00111	011
60.5	01000	011
61	01001	100
61.5	01010	100
62	01011	101
62.5	01100	101
63	01101	110
63.5	01110	110
64	01111	111

Divide Ratio settings consist of registers ROW10 bit <0> (MSB) and ROW11 bits <4:7> (4 LSBs)