

FEATURES

Frequency band: 57 GHz to 64 GHz
Radio frequency (RF) signal modulation bandwidth: up to 1.8 GHz
Noise figure (NF): 8 dB typical
Receiver gain: 0 dB to 69 dB
Digital and analog RF and intermediate frequency (IF) gain control
Programmable baseband gain and filter bandwidth
Integrated frequency synthesizer
Integrated image reject filter
Partially external loop filter
Support for external local oscillator (LO)
On-chip temperature sensor
Support for 256 quadrature amplitude modulation (QAM)
Integrated AM and FM detectors
Universal analog I/Q baseband interface
3-wire serial digital interface
75-ball, RoHS compliant, wafer level ball grid array

APPLICATIONS

Small cell backhaul
60 GHz industrial, scientific, and medical (ISM) band data transfer
Multiple Gbps data communication
WiGig/802.11ad radio
High definition video transmission
Radar/high resolution imaging

GENERAL DESCRIPTION

The **HMC6301** is a complete millimeterwave receiver integrated circuit in a 6 mm × 4 mm, RoHS compliant, wafer level ball grid array (WLBGA) that includes a low noise amplifier (LNA), an image reject filter, an RF to IF downconverter, an IF filter, an I/Q downconverter, and a frequency synthesizer. The receiver operates from 57 GHz to 64 GHz with up to 1.8 GHz of double-sided modulation bandwidth.

An integrated synthesizer provides tuning in 250 MHz, 500 MHz, or 540 MHz steps with excellent phase noise to support up to 64 QAM modulation. Optionally, an external LO can be injected allowing for user selectable LO characteristics or phase coherent transmit and receive operation, as well as modulation up to 256 QAM. Support for a wide variety of modulation formats is provided through a universal analog baseband I/Q interface.

The receiver device also contains AM and FM detectors to demodulate on-off keying (OOK), frequency-shift keying (FSK), or minimum-shift keying (MSK) modulation formats for lower cost and lower power serial data links without the need for high speed data converters.

Gain control is provided in the RF, IF, and baseband stages and a low 8 dB typical noise figure is supported at maximum gain. Together with the **HMC6300** transmitter, a complete 60 GHz transmit/receive chipset is provided for multiple Gbps operation in the unlicensed 60 GHz ISM band.

FUNCTIONAL BLOCK DIAGRAM

Figure 1.

Rev. A

[Document Feedback](#)

Information furnished by Analog Devices is believed to be accurate and reliable. However, no responsibility is assumed by Analog Devices for its use, nor for any infringements of patents or other rights of third parties that may result from its use. Specifications subject to change without notice. No license is granted by implication or otherwise under any patent or patent rights of Analog Devices. Trademarks and registered trademarks are the property of their respective owners.

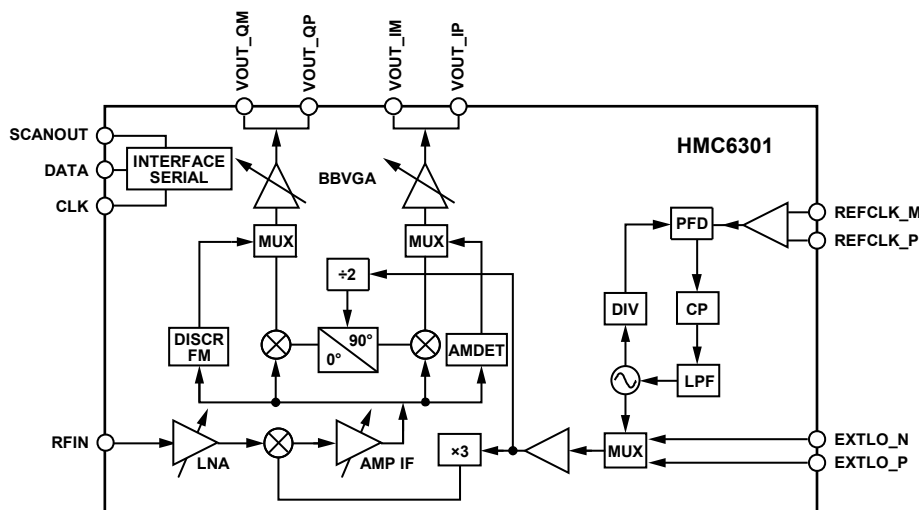
One Technology Way, P.O. Box 9106, Norwood, MA 02062-9106, U.S.A.
 Tel: 781.329.4700 ©2016 Analog Devices, Inc. All rights reserved.
[Technical Support](#) www.analog.com

HMC6301* PRODUCT PAGE QUICK LINKS

Last Content Update: 02/23/2017

COMPARABLE PARTS

View a parametric search of comparable parts.

EVALUATION KITS

- HMC6301 Evaluation Board

DOCUMENTATION

Data Sheet

- HMC6301: Millimeterwave Receiver, 57 GHz to 64 GHz Data Sheet

User Guides

- UG-1031: Getting Started with the EK1HMC6350 Evaluation Kit and Software

DESIGN RESOURCES

- HMC6301 Material Declaration
- PCN-PDN Information
- Quality And Reliability
- Symbols and Footprints

DISCUSSIONS

View all HMC6301 EngineerZone Discussions.

SAMPLE AND BUY

Visit the product page to see pricing options.

TECHNICAL SUPPORT

Submit a technical question or find your regional support number.

DOCUMENT FEEDBACK

Submit feedback for this data sheet.

TABLE OF CONTENTS

Features	1	ESD Caution.....	6
Applications.....	1	Pin Configuration and Function Descriptions.....	7
General Description	1	Typical Performance Characteristics	9
Functional Block Diagram	1	Theory of Operation	12
Revision History	2	Register Array Assignment and Serial Interface	12
Specifications.....	3	Receiver Register Array Assignments.....	13
Electrical Specifications.....	3	Applications Information	21
Recommended Operating Conditions	4	Outline Dimensions	24
Power Consumption	5	Ordering Guide	24
Absolute Maximum Ratings.....	6		

REVISION HISTORY

9/2016—v00.0716 to Rev. A

Updated Format.....	Universal
Changes to Features Section.....	1
Changes to Table 1.....	3
Changes to Parameter and Symbols Columns, Table 3	5
Changes to Figure 17.....	17
Added Ordering Guide	24

7/2016—Revision v00.0716: Initial Version

SPECIFICATIONS

T_A = 25°C, reference frequency = 71.4286 MHz, gain settings = maximum, IF bandwidth = maximum, input impedance = 50 Ω single ended, output impedance = 100 Ω differential, unless otherwise noted.

ELECTRICAL SPECIFICATIONS

Table 1.

Parameter	Test Conditions/Comments	Min	Typ	Max	Unit
FREQUENCY RANGE		57		64	GHz
FREQUENCY STEP SIZE	With 71.4286 MHz reference clock		250		MHz
	With 142.857 MHz reference clock		500		MHz
	With 154.2857 MHz reference clock		540		MHz
MODULATION BANDWIDTH	Maximum bandwidth setting				
	3 dB bandwidth		1.4		GHz
	5 dB bandwidth		1.8		GHz
GAIN					
Maximum Receiver Gain		63	69		dB
Minimum Receiver Gain			0		dB
Baseband Gain Control	High and low gain settings		41		dB
IF Gain Control (Analog/Digital)			12/15		dB
LNA Gain Control (Analog/Digital)			20/20		dB
NOISE FIGURE	At maximum gain		8	13.5	dB
INPUT	Minimum LNA gain				
For 1 dB Compression (P1dB)			-19		dBm
Third-Order Intercept (IP3)			-9		dBm
TEMPERATURE SENSOR RANGE	Four levels	-40		+85	°C
SUPPRESSION AND REJECTION					
Image Rejection (3 × LO – IF)			>35		dBc
Sideband Suppression (I/Q Balance)		20	23		dBc
PHASE					
Phase Noise					
@ 100 kHz Offset			-75		dBc/Hz
@ 1 MHz Offset			-93		dBc/Hz
@ 10 MHz Offset			-114		dBc/Hz
@ 100 MHz Offset			-122		dBc/Hz
Phase-Locked Loop (PLL) Bandwidth	Using internal filter		300		kHz
POWER DISSIPATION					
Single-Ended			0.82		W
External LO			0.57		W

RECOMMENDED OPERATING CONDITIONS

Table 2.

Parameter	Symbol	Min	Typ	Max	Unit
POWER SUPPLY					
Buffer	VCC _{BUF}	2.565	2.7	2.835	V dc
Low Noise Amplifier (LNA)	VDD _{LNA}	2.565	2.7	2.835	V dc
Tripler	VCC _{TRIP}	2.565	2.7	2.835	V dc
Divider	VCC _{DIV}	2.565	2.7	2.835	V dc
Voltage Controlled Oscillator (VCO)	VCC _{VCO}	2.565	2.7	2.835	V dc
Intermediate Frequency	VCC _{IF}	2.565	2.7	2.835	V dc
Mixer	VCC _{MIX}	2.565	2.7	2.835	V dc
Synthesizer	VCC _{SYN}	1.3	1.35	1.48	V dc
Digital Circuit	VDD _D	1.3	1.35	1.48	V dc
INPUT VOLTAGE RANGE					
Serial Digital Interface	DATA, ENABLE, CLK, RESET				
Logic High		0.9	1.2	1.4	V
Logic Low		-0.05	+0.1	+0.3	V
REFERENCE CLOCK					
Reference Clock, Positive LVPECL/LVDS CMOS	REF _{CLKP}		3.3/2.5 1.2		V V V
Reference Clock, Negative LVPECL/LVDS CMOS	REF _{CLKN}		3.3/2.5 1.2		V V
BASEBAND I/Q					
In-Phase Baseband Input Negative (Minus)	VOUT _{IM}	10	50	200	mV p-p
Positive	VOUT _{IP}	10	50	200	mV p-p
Quadrature Baseband Input Negative (Minus)	VOUT _{QM}	10	50	200	mV p-p
Positive	VOUT _{QP}	10	50	200	mV p-p
BASEBAND I/Q, COMMON MODE					
In-Phase Baseband Input Negative (Minus)	VOUT _{IM}		1.3		V
Positive	VOUT _{IP}		1.3		V
Quadrature Baseband Input Negative (Minus)	VOUT _{QM}		1.3		V
Positive	VOUT _{QP}		1.3		V
ANALOG GAIN CONTROL					
Low Noise Amplifier	ANACTRL _{LNA}	0.1		2.0	V
IF Variable Gain Amplifier	ACTL _{IFVGA}	0.1		2.25	V
EXTERNAL LO					
Positive	EXTLO _P	0	3	6	dBm
Negative	EXTLO _N	0	3	6	dBm
DRAIN CURRENT					
1.35 V			<1		mA
2.7 V			300		mA

POWER CONSUMPTION

Table 3.

Parameter	Voltage (V)	Typical Current (mA)	Typical Power Consumption (mW)
VCC _{BUF}	2.7	70	189
VCC _{LNA}	2.7	15	41
VCC _{TRP}	2.7	54	146
VCC _{DIV}	2.7	46	124
VCC _{VCO}	2.7	52	140
VCC _{IF}	2.7	30	81
VCC _{MIX}	2.7	32	86
VCC _{SYN}	1.35	0.08	0.1
VCC _D	1.35	10	13

ABSOLUTE MAXIMUM RATINGS

Table 4.

Parameter	Rating
VCC _{BUF}	2.85 V
VCC _{LNA}	2.85 V
VCC _{TRIP}	2.85 V
VCC _{DIV}	2.85 V
VCC _{VCO}	2.85 V
VCC _{IF}	2.85 V
VCC _{MIX}	2.85 V
VCC _{SYN}	1.6 V
VDD _D	1.6 V
Serial Digital Interface Input Voltage	1.5 V
Baseband Outputs: BB, FM (Each)	0.75 V p-p
RF Input Power	0 dBm
External LO Power	10 dBm
Thermal Resistance (R _{TH}), Junction to Ground Paddle	8.23°C/W
Storage Temperature	-55°C to +150°C
Operating Temperature	-40°C to 85°C
Reflow Temperature (Maximum Peak)	260°C
ESD Sensitivity, Charged Device Model (CDM)	Class C3 (250 V)

Stresses above those listed under Absolute Maximum Ratings may cause permanent damage to the device. This is a stress rating only; functional operation of the device at these or any other conditions above those indicated in the operational section of this specification is not implied. Exposure to absolute maximum rating conditions for extended periods may affect device reliability.

ESD CAUTION



ESD (electrostatic discharge) sensitive device. Charged devices and circuit boards can discharge without detection. Although this product features patented or proprietary protection circuitry, damage may occur on devices subjected to high energy ESD. Therefore, proper ESD precautions should be taken to avoid performance degradation or loss of functionality.

PIN CONFIGURATION AND FUNCTION DESCRIPTIONS

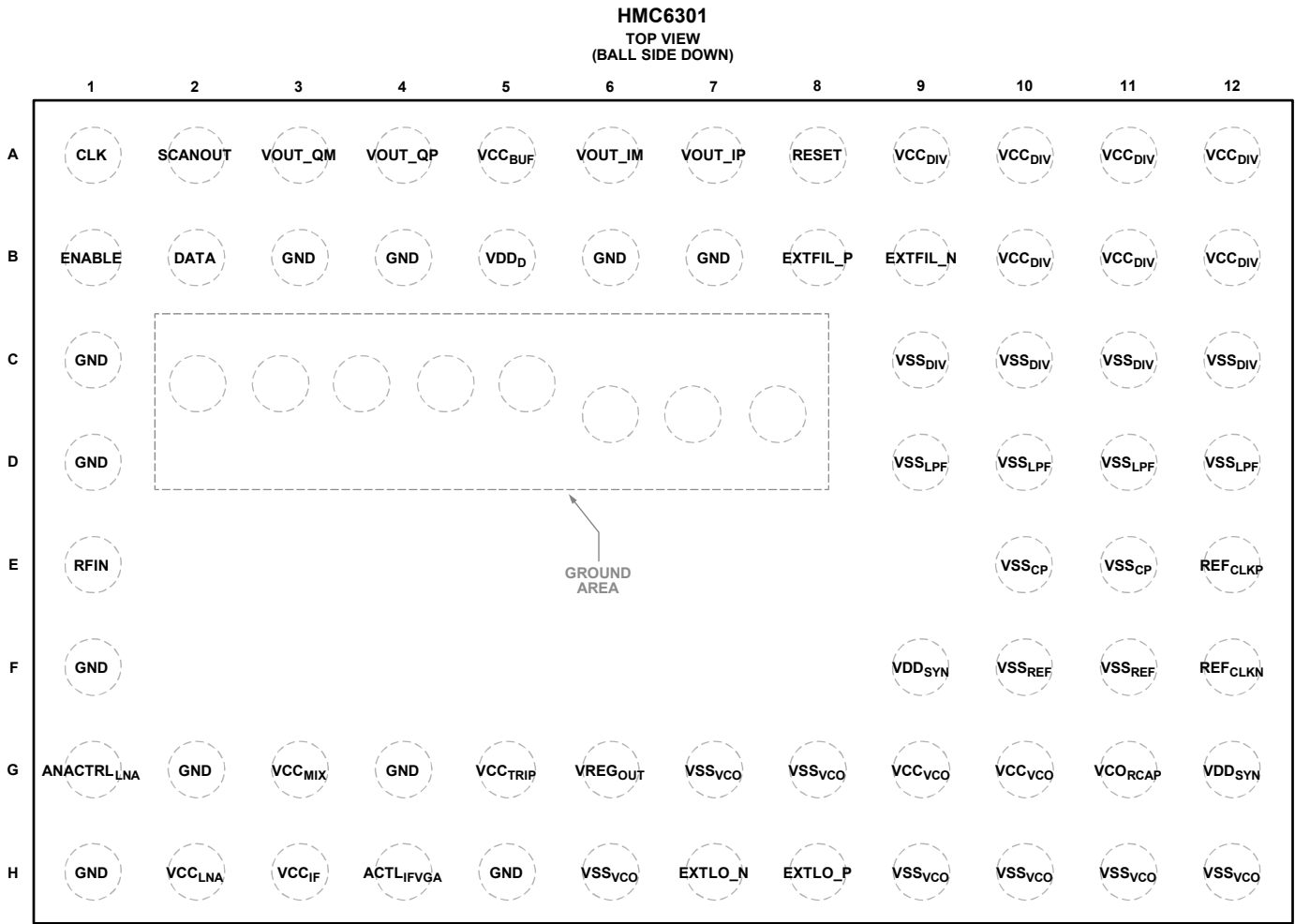

Figure 2. Pin Configuration Diagram

Table 5. Pin Function Descriptions

Pin No.	Mnemonic	Description
A1	CLK	Serial Digital Interface Clock (1.2 V CMOS).
A2	SCANOUT	Serial Digital Interface Out (1.2 V CMOS).
A3	VOUT_QM	Quadrature Negative Baseband Input. This pin is dc-coupled and matched to 50 Ω.
A4	VOUT_QP	Quadrature Positive Baseband Input. This pin is dc-coupled and matched to 50 Ω.
A5	VCC _{BUF}	Power Supply for the Buffer (2.7 V dc).
A6	VOUT_IM	In-Phase Negative Baseband Input. This pin is dc-coupled and matched to 50 Ω.
A7	VOUT_IP	In-Phase Positive Baseband Input. This pin is dc-coupled and matched to 50 Ω.
A8	RESET	Serial Digital Interface Reset (1.2 V CMOS).
A9 to A12, B10 to B12	VCC _{DIV}	Power Supply for the Divider (2.7 V dc).
B1	ENABLE	Serial Digital Interface Enable (1.2 V CMOS).
B2	DATA	Serial Digital Interface Data (1.2 V CMOS).
B3, B4, B6, B7, C1, D1, F1, G2, G4, H1, H5	GND	Analog Ground Connect.
B5	VDD _D	Power Supply for the Digital Circuits (1.3 V dc).
B8	EXTFIL_P	External PLL Loop Filter (Positive).
B9	EXTFIL_N	External PLL Loop Filter (Negative).

Pin No.	Mnemonic	Description
C9 to C12	VSS _{DIV}	Digital Ground for the Synthesizer Divider.
D9 to D12	VSS _{LPF}	Digital Ground for the Synthesizer Low-Pass Filter.
E1	RFIN	Radio Frequency Input. This pin is ac-coupled and matched to 50 Ω.
E10, E11	VSS _{CP}	Digital Ground for the Synthesizer Charge Pump.
E12	REF _{CLKP}	External Reference Clock (Positive). This pin can be dc or ac matched to 50 Ω.
F9, G12	VDD _{SYN}	Power Supply for the Synthesizer (1.3 V dc).
F10, F11	VSS _{REF}	Digital Ground for the Synthesizer Reference.
F12	REF _{CLKN}	External Reference Clock (Negative). This pin can be dc or ac matched to 50 Ω.
G1	ANACTRL _{LNA}	Analog Gain Control for the Low Noise Amplifier. Leave this pin floating for digital control.
G3	VCC _{MIX}	Power Supply for the Mixer (2.7 V dc).
G5	VCC _{TRIP}	Power Supply for the Tripler (2.7 V dc).
G6	VREG _{OUT}	Regulator Output for the Voltage Controlled Oscillator.
G7, G8, H6, H9 to H12	VSS _{VCO}	Digital Ground to the Synthesizer Voltage Controlled Oscillator.
G9, G10	VCC _{VCO}	Power Supply for the Voltage Controlled Oscillator (2.7 V dc).
G11	VCC _{RCAP}	External Capacitor Connection for the Voltage Controlled Oscillator Regulator.
H2	VCO _{LNA}	Power Supply for the Low Noise Amplifier (2.8 V dc).
H3	VCC _{IF}	Power Supply for the Intermediate Frequency (2.8 V dc).
H4	ACTL _{IFVGA}	Analog Gain Control for the IF Variable Gain Amplifier. Leave this pin floating for digital control.
H7	EXTLO _{_N}	External Local Oscillator (Negative) Input.
H8	EXTLO _{_P}	External Local Oscillator (Positive) Input.

TYPICAL PERFORMANCE CHARACTERISTICS

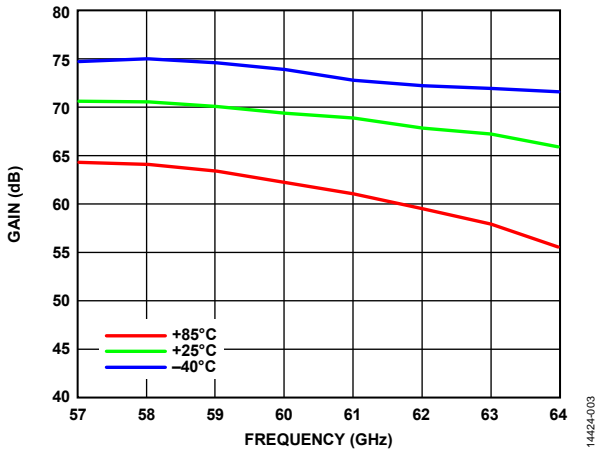

Figure 3. Maximum Gain vs. Frequency over Temperature, IF and RF Attenuation = 0 dBm

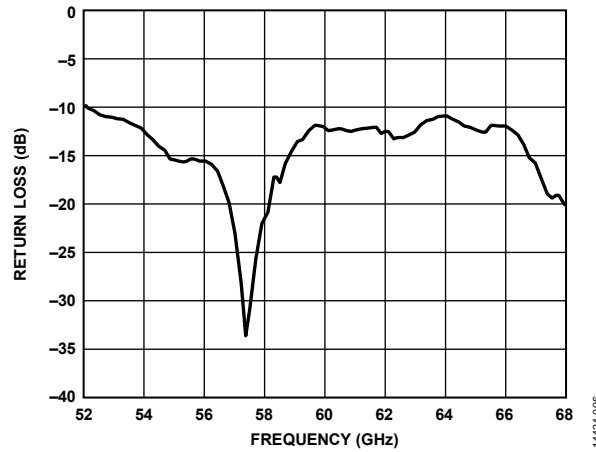

Figure 6. Return Loss vs. Frequency

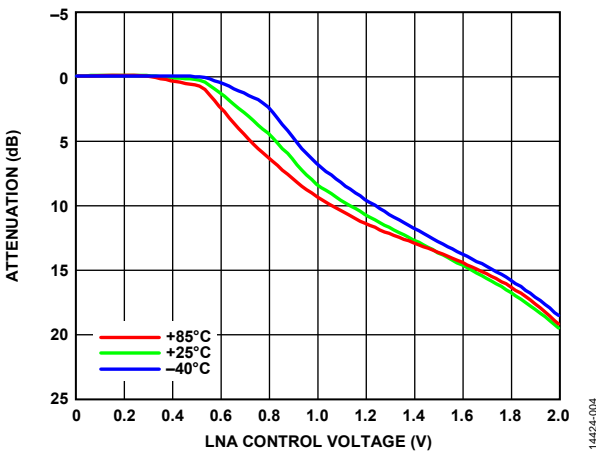

Figure 4. LNA Attenuation vs. Analog Control Voltage over Temperature, Measurement Taken at 60 GHz, IF Attenuation = 0 dBm

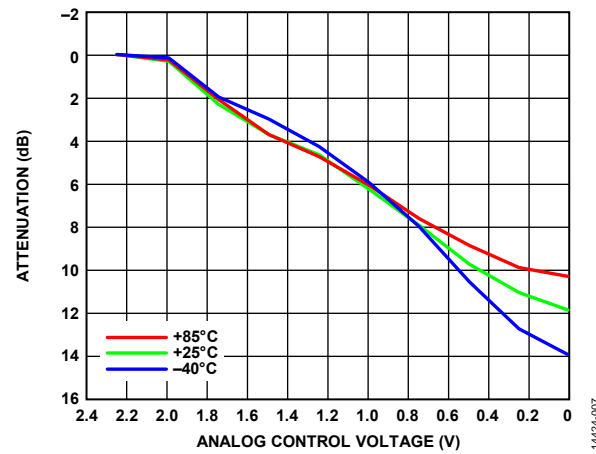

Figure 7. IF Attenuation vs. Analog Control Voltage over Temperature, Measurement Taken at 60 GHz, RF Attenuation = 0 dBm

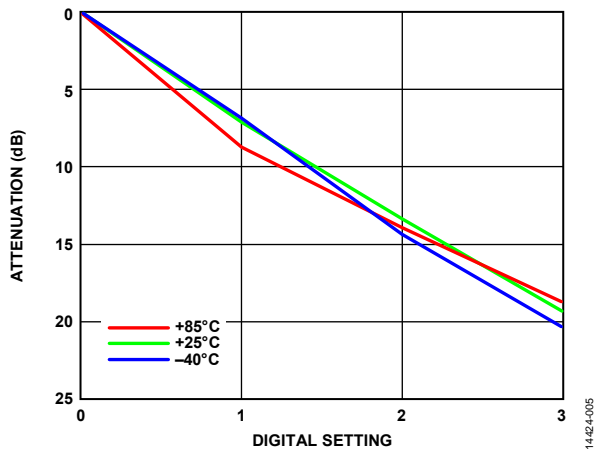

Figure 5. LNA Attenuation vs. Digital Setting over Temperature, Measurement Taken at 60 GHz, IF Attenuation = 0 dBm

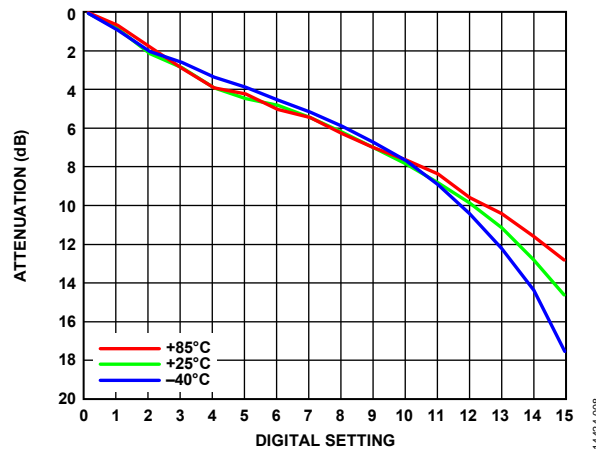

Figure 8. IF Attenuation vs. Digital Setting over Temperature, Measurement Taken at 60 GHz, RF Attenuation = 0 dBm

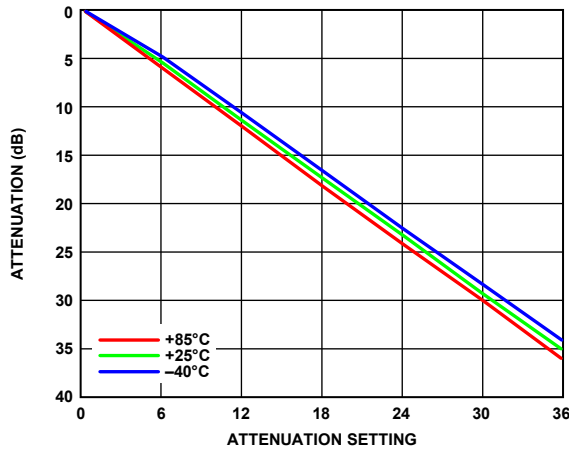

Figure 9. Baseband Attenuation vs. Attenuation Setting over Temperature, Measurement Taken at 60 GHz

14424-009

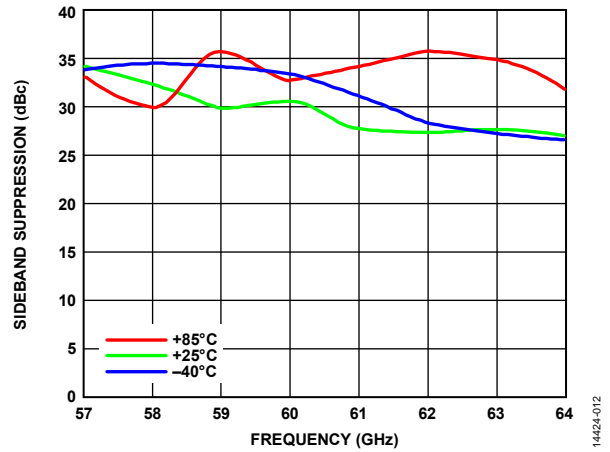

Figure 12. Sideband Suppression vs. Frequency over Temperature, Measurement Taken at Maximum Gain

14424-012

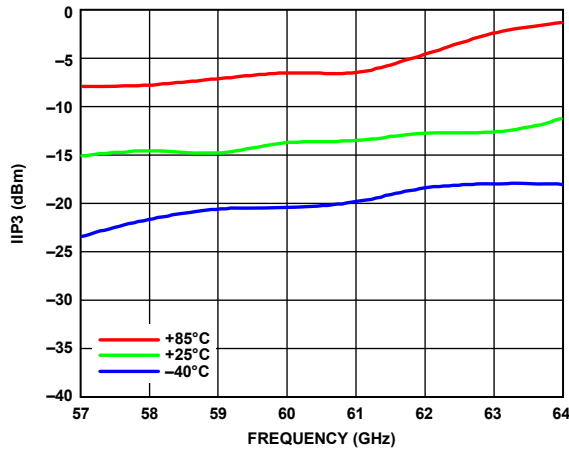

Figure 10. Input IP3 (IIP3) vs. Frequency over Temperature, Minimum LNA Gain, Measurement Taken at Maximum IF Gain and Maximum Baseband Attenuation

14424-010

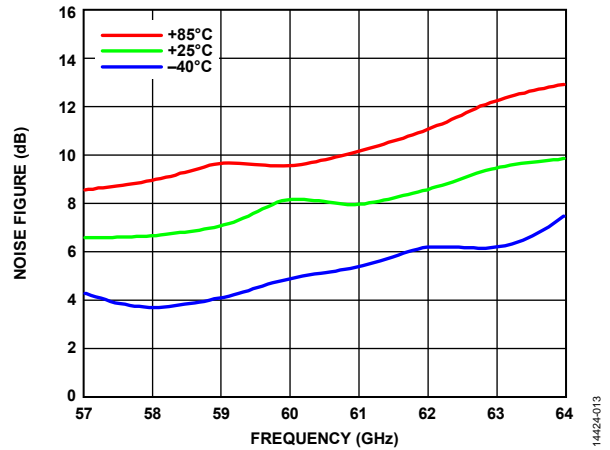

Figure 13. Noise Figure vs. Frequency over Temperature

14424-013

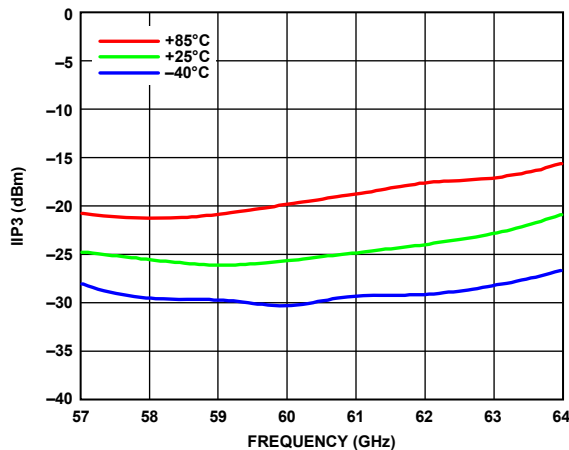

Figure 11. Input IP3 (IIP3) vs. Frequency over Temperature, Minimum LNA Gain, Measurement Taken at Maximum IF Gain and Maximum Baseband Attenuation

14424-011

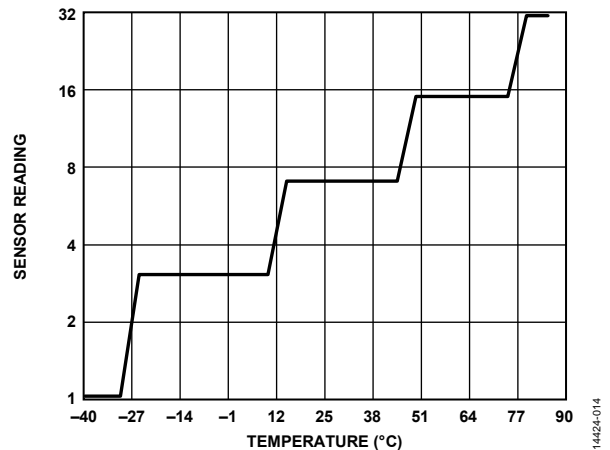

Figure 14. Temperature Sensor Reading vs. Temperature

14424-014

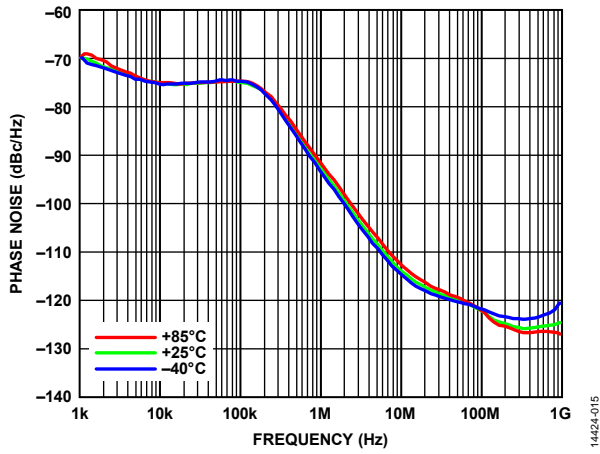

Figure 15. Phase Noise vs. Frequency Offset over Temperature, Internal LO, Measurement Taken at 60 GHz and Nominal Bias

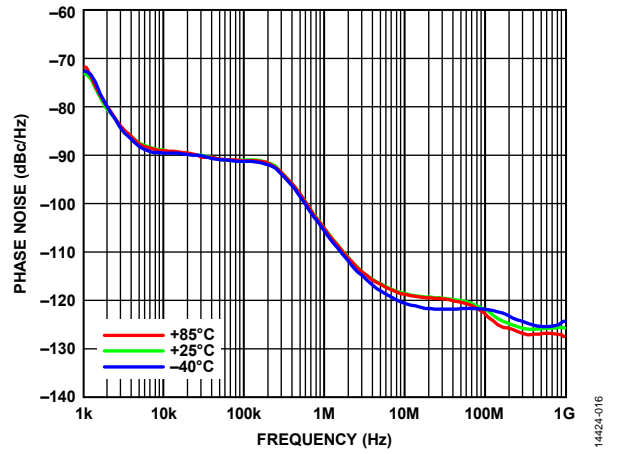

Figure 16. Phase Noise vs. Frequency Offset over Temperature, External LO, Measurement Taken at 60 GHz and Nominal Bias

THEORY OF OPERATION

An integrated frequency synthesizer creates a low phase noise LO between 16.3 GHz and 18.3 GHz. The step size of the synthesizer equates to 250 MHz steps at RF when used with a 71.42857 MHz reference crystal or to 500 MHz if used with a 142.857 reference crystal. To support IEEE channels (ISM band) with a 540 MHz step size, use a 154.2857 MHz reference crystal.

A 57 GHz to 64 GHz signal enters the chip through a single-ended LNA input. The LNA provides 20 dB of variable gain. The LO is multiplied by three and mixed with the LNA output to downconvert to an 8.14 GHz to 9.1 GHz sliding IF. An integrated notch filter removes the image frequency at 40 GHz to 46 GHz. The IF signal is filtered and amplified with 14 dB of variable gain. If the chip is configured for I/Q baseband output, the IF signal feeds into a quadrature demodulator using the LO/2 to downconvert to baseband. There are also options to use on-chip demodulators capable of demodulating AM/FM/FSK/MSK waveforms.

The phase noise and quadrature balance of the on-chip synthesizer is sufficient to support up to 64 QAM modulation. For higher order modulation up to 256 QAM or less than a 250 MHz step size, the HMC6301 can operate using an external LO.

The HMC6301 receiver is ideal for FDD operation along with the HMC6300 transmitter chip. However, both devices can support TDD operation by enabling and disabling the circuits. All of the enables are placed in Register Array 4, allowing full chip enable or disable in one SPI write.

There are no special power sequencing requirements for the HMC6301; apply all voltages simultaneously.

REGISTER ARRAY ASSIGNMENT AND SERIAL INTERFACE

The register arrays for both the receiver and transmitter are organized into 32 rows of 8 bits. Using the serial interface, the arrays are written to or read from one row at a time, as shown in Figure 17 and Figure 18, respectively. Figure 17 shows the sequence of signals on the ENABLE, CLK, and DATA lines to write one 8-bit row of the register array. The ENABLE line goes low, the first of 18 data bits (Bit 0) is placed on the DATA line, and 2 ns or more after the DATA line stabilizes, the CLK line goes high to clock in Data Bit 0. The DATA line must remain stable for at least 2 ns after the rising edge of CLK.

A write operation requires 18 data bits and 18 clock pulses, as shown in Figure 17. The 18 data bits contain the 8-bit register array row data (the least significant bit (LSB) is clocked in first), followed by the register array row address (ROW0 through ROW23, 000000 to 001111, LSB first), the read/write bit (set to 1 to write), and finally, the receiver chip address, 111, LSB first).

The receiver IC serial interface was tested to 500 MHz, and the interface is 1.2 V CMOS levels.

Note that the register array row address is 6 bits but only four are used to designate 32 rows, the two most significant bits (MSBs) are 0.

After the 18th clock pulse of the write operation, the ENABLE line returns high to load the register array on the IC; prior to the rising edge of the ENABLE line, no data is written to the array. The CLK line should have stabilized in the low state at least 2 ns prior to the rising edge of the ENABLE line.

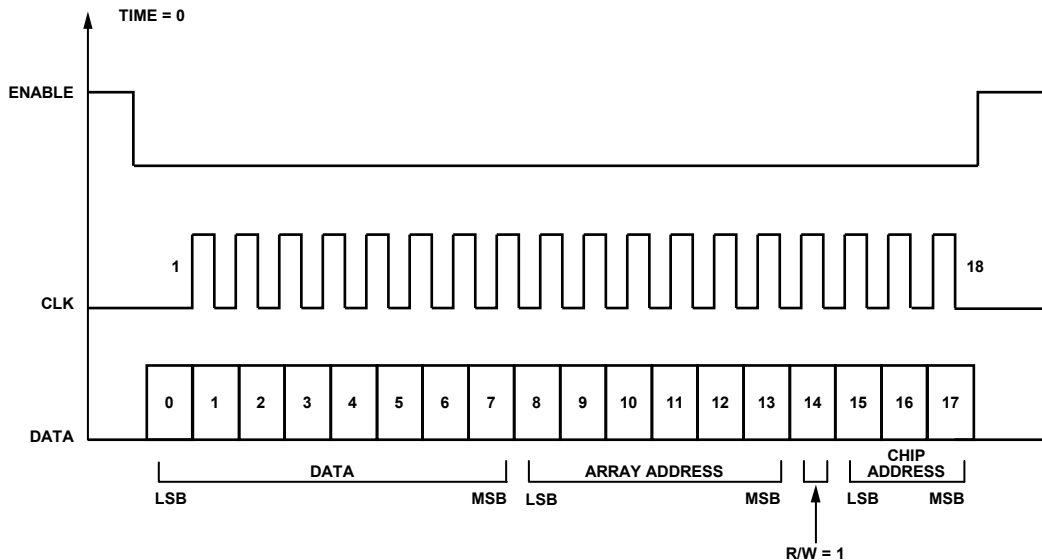

Figure 17. Timing Diagram for Writing a Row of the Receiver Serial Interface

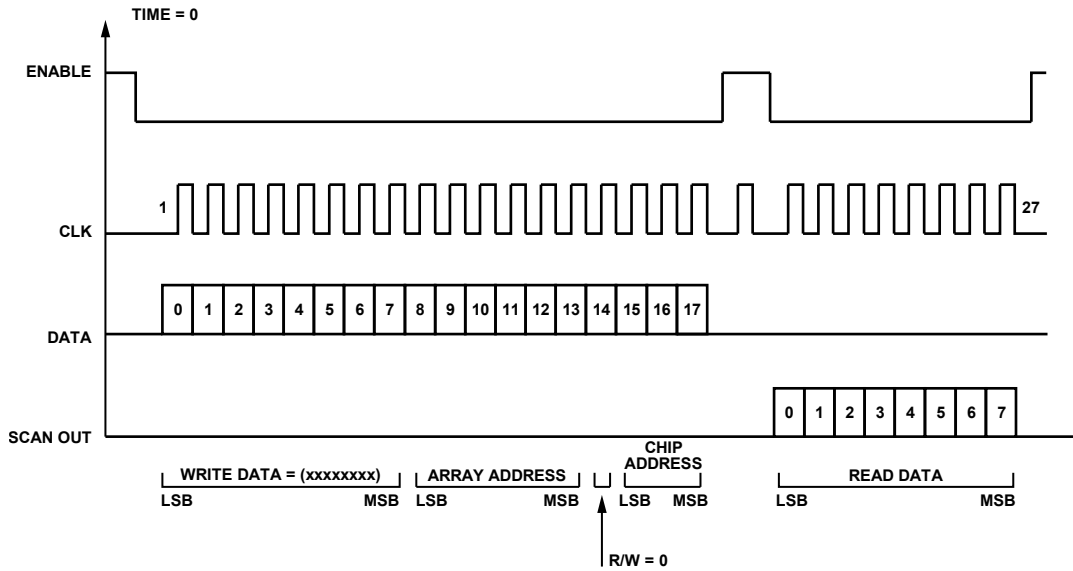

Figure 18. Timing Diagram for Reading a Row of the Receiver Serial Interface

14424-018

RECEIVER REGISTER ARRAY ASSIGNMENTS

All register arrays are read/write, unless otherwise noted.

Table 6. Receiver Register Array Assignments

Register Array Row, Bit	Internal Signal Name	Signal Function	
ROW0			
ROW0, Bit 7	lna_pwrdown	Active high to power down the LNA.	
ROW0, Bit 6	bbamp_pwrdown_i	Active high to power down the baseband I channel.	
ROW0, Bit 5	bbamp_pwrdown_q	Active high to power down the baseband Q channel.	
ROW0, Bit 4	divider_pwrdown	Active high to power down the LO divider.	
ROW0, Bit 3	mixer_pwrdown	Active high to power down the RF mixer.	
ROW0, Bit 2	ifmixer_pwrdown/ifmixer_pwrdown_i	Active high to power down the I channel IF mixer.	
ROW0, Bit 1	tripler_pwrdown	Active high to power down the LO tripler.	
ROW0, Bit 0	ifvga_pwrdown	Active high to power down the IF VGA.	
ROW1			
ROW1, Bit 7	ipc_pwrdown	Active high to power down on-chip current reference generator.	
ROW1, Bit 6	ifmix_pwrdown_q	Active high to power down the Q channel IF mixer.	
ROW1, Bit 5	if_bgmux_pwrdown	Active high to power down one of the three on-chip band gap references (IF) and associated mux.	
ROW1, Bit 4	ask_pwrdown	Active high to power down the ASK demodulator.	
ROW1, Bit 3	bbamp_atten1_0	Controls first baseband attenuator; ROW1, Bits[2:3]. 11 is 18 dB attenuation. 10 is 12 dB attenuation. 01 is 6 dB attenuation. 00 is 0 dB attenuation.	
ROW1, Bit 2	bbamp_atten1_1		
ROW1, Bit 1	bbamp_sell_ask		Active high to multiplex the AM detector output into the I channel baseband amplifier input.
ROW1, Bit 0	bbamp_sigshort		Active high to short the input to the I and Q channel baseband amplifiers.

Register Array Row, Bit	Internal Signal Name	Signal Function
ROW2 ROW2, Bit 7 ROW2, Bit 6 ROW2, Bit 5 ROW2, Bit 4 ROW2, Bit 3 ROW2, Bit 2 ROW2, Bit 1 ROW2, Bit 0	bbamp_attenfi_0 bbamp_attenfi_1 bbamp_attenfi_2 bbamp_attenfq_0 bbamp_attenfq_1 bbamp_attenfq_2 bbamp_atten2_0 bbamp_atten2_1	Controls I channel baseband fine attenuator; ROW2[5:7]. 101 is 5 dB attenuation. 100 is 4 dB attenuation. 011 is 3 dB attenuation. 010 is 2 dB attenuation. 001 is 1 dB attenuation. 000 is 0 dB attenuation. Controls Q channel baseband fine attenuator; ROW2[2:4]. 101 is 5 dB attenuation. 100 is 4 dB attenuation. 011 is 3 dB attenuation. 010 is 2 dB attenuation. 001 is 1 dB attenuation. 000 is 0 dB attenuation. Controls second bandband attenuator; ROW2[0:1]. 11 is 18 dB attenuation. 10 is 12 dB attenuation. 01 is 6 dB attenuation. 00 is 0 dB attenuation.
ROW3 ROW3, Bit 7 ROW3, Bit 6 ROW3, Bit 5 ROW3, Bit 4 ROW3, Bit 3 ROW3, Bit 2 ROW3, Bit 1 ROW3, Bit 0	bbamp_selbw0 bbamp_selbw1 bbamp_selfastrec bbamp_selfastrec2 bg_monitor_sel<1> bg_monitor_sel<0> if_refsel ina_refsel	Selects the low-pass corner of the baseband amplifiers; ROW3[6:7]. 00 is \approx 1.4 GHz. 01 is \approx 500 MHz. 10 is \approx 300 MHz. 11 is \approx 200 MHz. Selects the high-pass corner of the baseband amplifiers; ROW3[4:5]. 00 is \approx 45 kHz. 01 is \approx 350 kHz. 10 is \approx 1.6 MHz. For diagnostic purposes; ROW3[3:0] = 0011 for normal operation.
ROW4 ROW4, Bit 7 ROW4, Bit 6 ROW4, Bit 5 ROW4, Bit 4 ROW4, Bit 3 ROW4, Bit 2 ROW4, Bit 1 ROW4, Bit 0	ifvga_bias<2> ifvga_bias<1> ifvga_bias<0> ifvga_tune<3> ifvga_tune<2> ifvga_tune<1> ifvga_tune<0> enDigVGA	Controls bias and IF filter alignment in the IF variable gain amplifier; ROW4[7:1] = 1001111 for normal operation Active high to enable the digital control of the IF VGA gain
ROW5 ROW5, Bit 7 ROW5, Bit 6 ROW5, Bit 5 ROW5, Bit 4 ROW5, Bit 3 ROW5, Bit 2 ROW5, Bit 1 ROW5, Bit 0	ifvga_vga_adj<3> ifvga_vga_adj<2> ifvga_vga_adj<1> ifvga_vga_adj<0> rfmix_tune<3> rfmix_tune<2> rfmix_tune<1> rfmix_tune<0>	Controls IF variable gain amplifier; ROW5[7:4]. 0000 is the highest gain. 1111 is the lowest gain. Controls IF filter alignment in the RF mixer; ROW5[3:0] = 1111 for normal operation.

Register Array Row, Bit	Internal Signal Name	Signal Function
ROW6 ROW6, Bit 7 ROW6, Bit 6 ROW6, Bit 5 ROW6, Bit 4 ROW6, Bit 3 ROW6, Bit 2 ROW6, Bit 1 ROW6, Bit 0	tripler_bias<13> tripler_bias<12> tripler_bias<11> tripler_bias<10> tripler_bias<9> tripler_bias<8> tripler_bias<7> tripler_bias<6>	Controls the bias of the frequency tripler; ROW6[7:0] = 10111111 for normal operation.
ROW7 ROW7, Bit 7 ROW7, Bit 6 ROW7, Bit 5 ROW7, Bit 4 ROW7, Bit 3 ROW7, Bit 2 ROW7, Bit 1 ROW7, Bit 0	tripler_bias<5> tripler_bias<4> tripler_bias<3> tripler_bias<2> tripler_bias<1> tripler_bias<0> bbamp_selfm fm_pwrdn	Controls the bias of the frequency tripler; ROW7[7:2] = 011011 for normal operation. Active high to multiplex the FM detector output into the Q channel baseband amplifier input. Active high to power down FM demodulator.
ROW8 ROW8, Bit 7 ROW8, Bit 6 ROW8, Bit 5 ROW8, Bit 4 ROW8, Bit 3 ROW8, Bit 2 ROW8, Bit 1 ROW8, Bit 0	lna_bias<2> lna_bias<1> lna_bias<0> lna_gain<1> na_gain<0> ifvga_q_cntrl<2> ifvga_q_cntrl<1> ifvga_q_cntrl<0>	Controls bias of the low noise amplifier; ROW8[7:5] = 100 for normal operation. Controls LNA variable gain; ROW8[4:3]. 00 is the highest gain. 11 is the lowest gain. Controls the Q of the IF filter in the IF variable gain amplifier; ROW8[2:0] = 000 for the highest Q and the highest gain. To reduce Q and widen bandwidth, increment ROW8[2:0] in the sequence: 001 100 101 111.
ROW9 ROW9, Bit 7 ROW9, Bit 6 ROW9, Bit 5 ROW9, Bit 4 ROW9, Bit 3 ROW9, Bit 2 ROW9, Bit 1 ROW9, Bit 0	enAnaV_LNA enbar_TempS en_tempFlash en_Sep_ifmix_pwrdn_q Not used Not used Not used Not used	Active high enable analog gain control of the LNA. Active high to power down the temperature sensor. Active high to enable the temperature sensor. Enable separate power down for the IF mixer I/Q 0 for normal operation. Not used. Not used. Not used. Not used.
ROW10	Not used	Not used.
ROW11	Not used	Not used.
ROW12	Not used	Not used.
ROW13	Not used	Not used.
ROW14	Not used	Not used.
ROW15	Not used	Not used.

Register Array Row, Bit	Internal Signal Name	Signal Function
ROW16		
ROW16, Bit 7	byp_synth_LDO	Factory diagnostics, 0 for normal operation.
ROW16, Bit 6	en_cpShort	Factory diagnostics, 0 for normal operation.
ROW16, Bit 5	en_cpCMFB	Enables CMFB circuit for charge pump, set to 1 when synthesizer is in use.
ROW16, Bit 4	en_cp_dump	Enables auxiliary circuit for charge pump, set to 1 when synthesizer is in use.
ROW16, Bit 3	en_cpTRIST	Factory diagnostics, 0 for normal operation.
ROW16, Bit 2	en_cp	Enables charge pump, set to 1 when synthesizer is in use.
ROW16, Bit 1	en_synth_LDO	Enables LDO for synthesizer, set to 1 when synthesizer is in use.
ROW16, Bit 0	enbar_synthBG	Factory diagnostics, 0 for normal operation.
ROW17		
ROW17, Bit 7	en_lockd_clk	Enables lock detector for synthesizer, set to 1 when synthesizer is in use.
ROW17, Bit 6	en_test_divOut	Factory diagnostics, 0 for normal operation.
ROW17, Bit 5	en_vtune_flash	Enables flash ADCs for VCO vtune port, set to 1 when synthesizer is in use.
ROW17, Bit 4	en_reBuf_DC	Enables dc coupling for reference clock buffer.
ROW17, Bit 3	en_refBuf	Enables reference clock buffer, set to 1 when synthesizer is in use.
ROW17, Bit 2	en_stick_div	Factory diagnostics, 0 for normal operation.
ROW17, Bit 1	en_FBDiv_cml2cmos	Enables auxiliary circuit for the feedback divider chain, set to 1 when synthesizer is in use.
ROW17, Bit 0	en_FBDiv	Enables feedback divider chain, set to 1 when synthesizer is in use.
ROW18		
ROW18, Bit 7	Not used.	Not used.
ROW18, Bit 6	en_nb250m	Active high to enable 250 MHz channel step size.
ROW18, Bit 5	byp_vco_LDO	Factory diagnostics, 0 for normal operation.
ROW18, Bit 4	en_extLO	Enables external LO, set to 0 when synthesizer is in use.
ROW18, Bit 3	en_vcoPk	Factory diagnostics, 0 for normal operation.
ROW18, Bit 2	en_vco	Enables internal VCO, set to 1 when synthesizer is in use.
ROW18, Bit 1	en_vco_reg	Enables internal regulator for VCO, set to 1 when synthesizer is in use.
ROW18, Bit 0	enbar_vcoGB	Factory diagnostics, 0 for normal operation.
ROW19		
ROW19, Bit 7	Not used	Not used.
ROW19, Bit 6	Not used	Not used.
ROW19, Bit 5	Not used	Not used.
ROW19, Bit 4	Not used	Not used.
ROW19, Bit 3	Not used	Not used.
ROW19, Bit 2	Not used	Not used.
ROW19, Bit 1	refsel_synthBG	Factory diagnostics, 1 for normal operation.
ROW19, Bit 0	muxRef	Factory diagnostics, 0 for normal operation.
ROW20		
ROW20, Bit 7	Not used	Not used.
ROW20, Bit 6	Fbdiv_code<6>	Feedback divider ratio for the integer-N internal synthesizer based on Table 7, Table 8, and Table 9.
ROW20, Bit 5	Fbdiv_code<5>	
ROW20, Bit 4	Fbdiv_code<4>	
ROW20, Bit 3	Fbdiv_code<3>	
ROW20, Bit 2	Fbdiv_code<2>	
ROW20, Bit 1	Fbdiv_code<1>	
ROW20, Bit 0	Fbdiv_code<0>	

Register Array Row, Bit	Internal Signal Name	Signal Function
ROW21		
ROW21, Bit 7	Not used	Not used.
ROW21, Bit 6	Not used	Not used.
ROW21, Bit 5	Not used	Not used.
ROW21, Bit 4	refsel_vcoBG	Factory diagnostics, 1 for normal operation.
ROW21, Bit 3	vco_biasTrim<3>	Sets VCO tank bias current ROW21[3:0] = 0010 for normal operation.
ROW21, Bit 2	vco_biasTrim<2>	
ROW21, Bit 1	vco_biasTrim<1>	
ROW21, Bit 0	vco_biasTrim<0>	
ROW22		
ROW22, Bit 7	Not used	Not used.
ROW22, Bit 6	Not used	Not used.
ROW22, Bit 5	Not used	Not used.
ROW22, Bit 4	vco_bandSel<4>	Set for desired frequency. Table 7, Table 8, and Table 9. contain approximate band setting depending on reference clock frequency.
ROW22, Bit 3	vco_bandSel<3>	ROW22[4:0] = valid range 00000-10011.
ROW22, Bit 2	vco_bandSel<2>	
ROW22, Bit 1	vco_bandSel<1>	
ROW22, Bit 0	vco_bandSel<0>	
ROW23		
ROW23, Bit 7	ICP_BiasTrim<2>	Sets charge pump current. ROW23[7:5] = 011 for normal operation.
ROW23, Bit 6	ICP_BiasTrim<1>	
ROW23, Bit 5	ICP_BiasTrim<0>	
ROW23, Bit 4	vco_offset<0>	Sets internal VCO output swing. ROW23[4:0] = 00010 for normal operation.
ROW23, Bit 3	vco_offset<1>	
ROW23, Bit 2	vco_offset<2>	
ROW23, Bit 1	vco_offset<3>	
ROW23, Bit 0	vco_offset<4>	
ROW24 (Read Only)		
ROW24, Bit 7	Not used	Not used.
ROW24, Bit 6	Not used	Not used.
ROW24, Bit 5	Not used	Not used.
ROW24, Bit 4	Not used	Not used.
ROW24, Bit 3	lockdet	Monitor for lock detect, 1 indicates valid lock.
ROW24, Bit 2	dn	Monitor VCO amplitude.
ROW24, Bit 1	up	Monitor VCO amplitude.
ROW24, Bit 0	center	Monitor VCO amplitude.
ROW25 (Read Only)		
ROW25, Bit 7	vtune_flashp<7>	VCO amplitude monitor (positive).
ROW25, Bit 6	vtune_flashp<6>	
ROW25, Bit 5	vtune_flashp<5>	
ROW25, Bit 4	vtune_flashp<4>	
ROW25, Bit 3	vtune_flashp<3>	
ROW25, Bit 2	vtune_flashp<2>	
ROW25, Bit 1	vtune_flashp<1>	
ROW25, Bit 0	vtune_flashp<0>	

Register Array Row, Bit	Internal Signal Name	Signal Function
ROW26 (Read Only)		
ROW26, Bit 7	vtune_flashn<7>	VCO amplitude monitor (negative).
ROW26, Bit 6	vtune_flashn<6>	
ROW26, Bit 5	vtune_flashn<5>	
ROW26, Bit 4	vtune_flashn<4>	
ROW26, Bit 3	vtune_flashn<3>	
ROW26, Bit 2	vtune_flashn<2>	
ROW26, Bit 1	vtune_flashn<1>	
ROW26, Bit 0	vtune_flashn<0>	
ROW27 (Read Only)		
ROW27, Bit 7	Not used	Not used.
ROW27, Bit 6	Not used	Not used.
ROW27, Bit 5	Not used	Not used.
ROW27, Bit 4	tempS<4>	Thermometer encoded temperature reading. ROW27[4:0] = the following: 00000 is the lowest temperature. 11111 is the highest temperature.
ROW27, Bit 3	tempS<3>	
ROW27, Bit 2	tempS<2>	
ROW27, Bit 1	tempS<1>	
ROW27, Bit 0	tempS<0>	
ROW28	Not used	Not used.
ROW29	Not used	Not used.
ROW30	Not used	Not used.
ROW31	Not used	Not used.

Synthesizer Settings**Table 7. Synthesizer Settings, IEEE Channels Using 154.2857 MHz Reference**

Frequency (GHz)	IEEE Channel	Divider Setting, Fbdiv_Code<5:0>, ROW20, Bits[5:0]	Typical Band Setting, vco_bandSel<4:0>, ROW22, Bits[4:0]
57.24		001010	00001
57.78		001011	00010
58.32	Channel 1	001100	00010
58.86		001101	00010
59.40		001110	00011
59.94		001111	00011
60.48	Channel 2	010000	00100
61.02		010001	00100
61.56		010010	00101
62.10		010011	00101
62.64	Channel 3	010100	00101
63.18		010101	00110
63.72		010110	00110
64.26		010111	00110
64.8	Channel 4	011000	00111
65.34		011001	00111
65.88		011010	01000

Table 8. 500 MHz Channels Using 142.8571 MHz Reference

Frequency (GHz)	Divider Setting	Typical Band Setting
56.5	010001	00001
57	010010	00001
57.5	010011	00010
58	010100	00010
58.5	010101	00010
59	010110	00011
59.5	010111	00011
60	011000	00100
60.5	011001	00100
61	011010	00101
61.5	011011	00101
62	011100	00101
62.5	011101	00110
63	011110	00110
63.5	011111	00110
64	100000	00111

Table 9. 250 MHz Channels Using 71.42857 MHz Reference

Frequency (GHz)	Divider Setting	Typical Band Setting
56.5	0100010	00001
56.75	0100011	00001
57	0100100	00010
57.25	0100101	00010
57.5	0100110	00011
57.75	0100111	00011
58	0101000	00100
58.25	0101001	00100
58.5	0101010	00101
58.75	0101011	00101
59	0101100	00110
59.25	0101101	00110
59.5	0101110	00111
59.75	0101111	00111
60	0110000	01000
60.25	0110001	01000
60.5	0110010	01001
60.75	0110011	01001
61	0110100	01010
61.25	0110101	01010
61.5	0110110	01011
61.75	0110111	01011
62	0111000	01100
62.25	0111001	01100
62.5	0111010	01101
62.75	0111011	01101
63	0111100	01110
63.25	0111101	01110
63.5	0111110	01111
63.75	0111111	01111
64	1000000	01111

APPLICATIONS INFORMATION

For more information about the [HMC6301](#) evaluation kit, see the [EK1HMC6350 User Guide](#). The [EK1HMC6350](#) contains all that is required to set up a simplex 60 GHz millimeterwave link using standard RF cable interfaces for baseband input and output. The kit comes with two motherboard printed circuit

boards (PCBs) that provide on-board crystals, USB interface, supply regulators, and SMA cables for connectorized I/Q interfaces. Software is supplied to allow the user to read from and write to all chip level registers using graphical user interface (GUI) or to upload previously saved register settings.

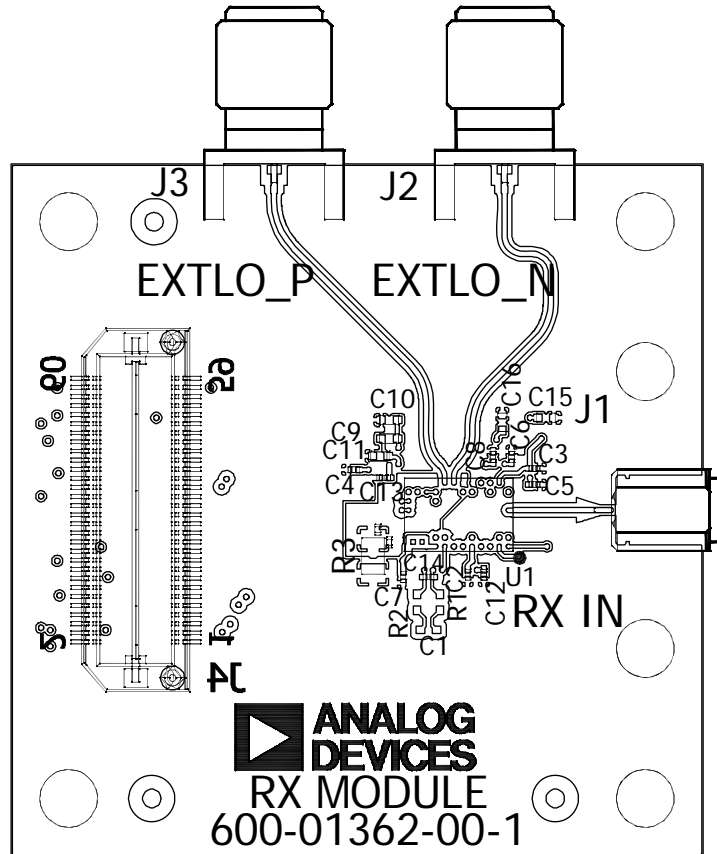
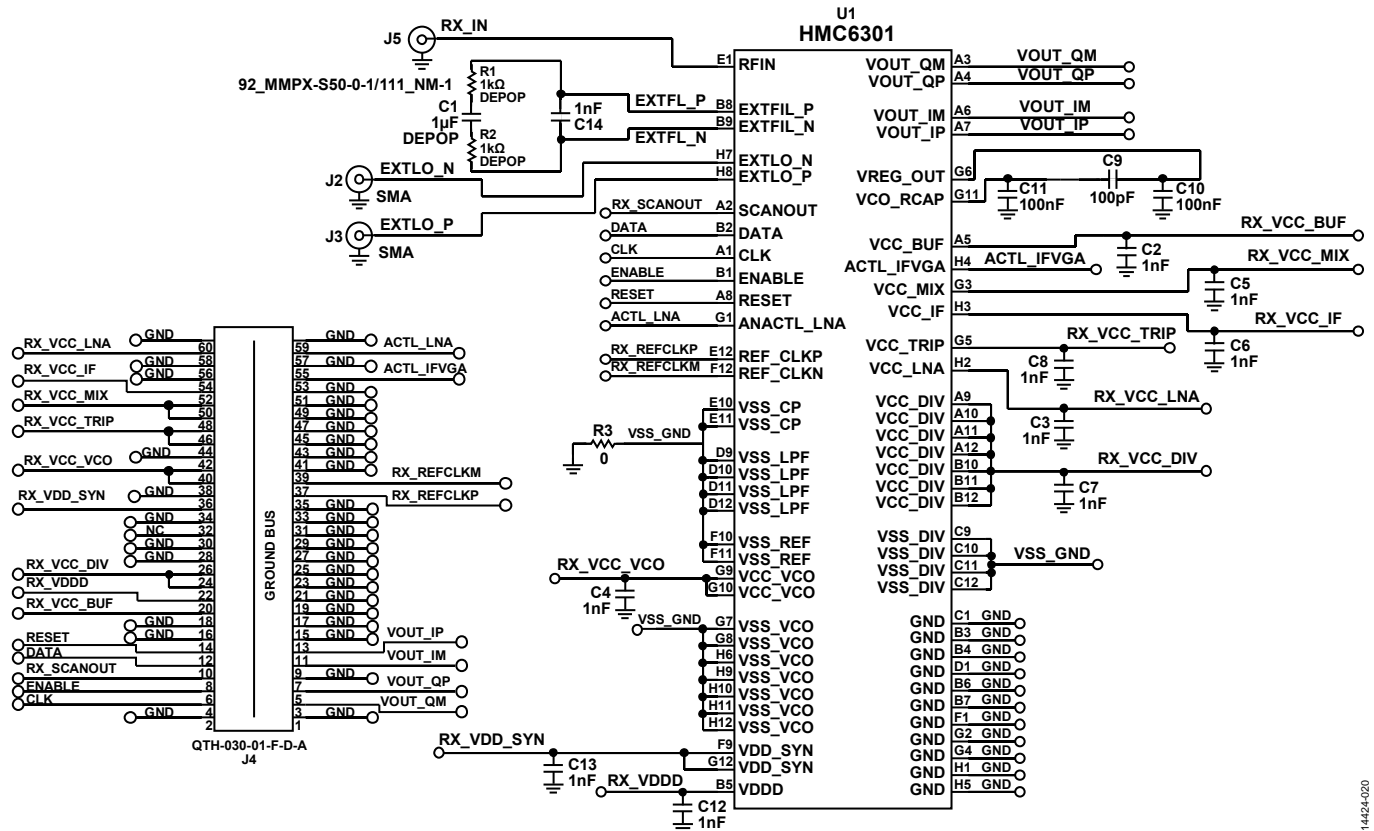

Figure 19. [HMC6301](#) (600-01362-00-1) Evaluation PCB Daughter Board



14424-020

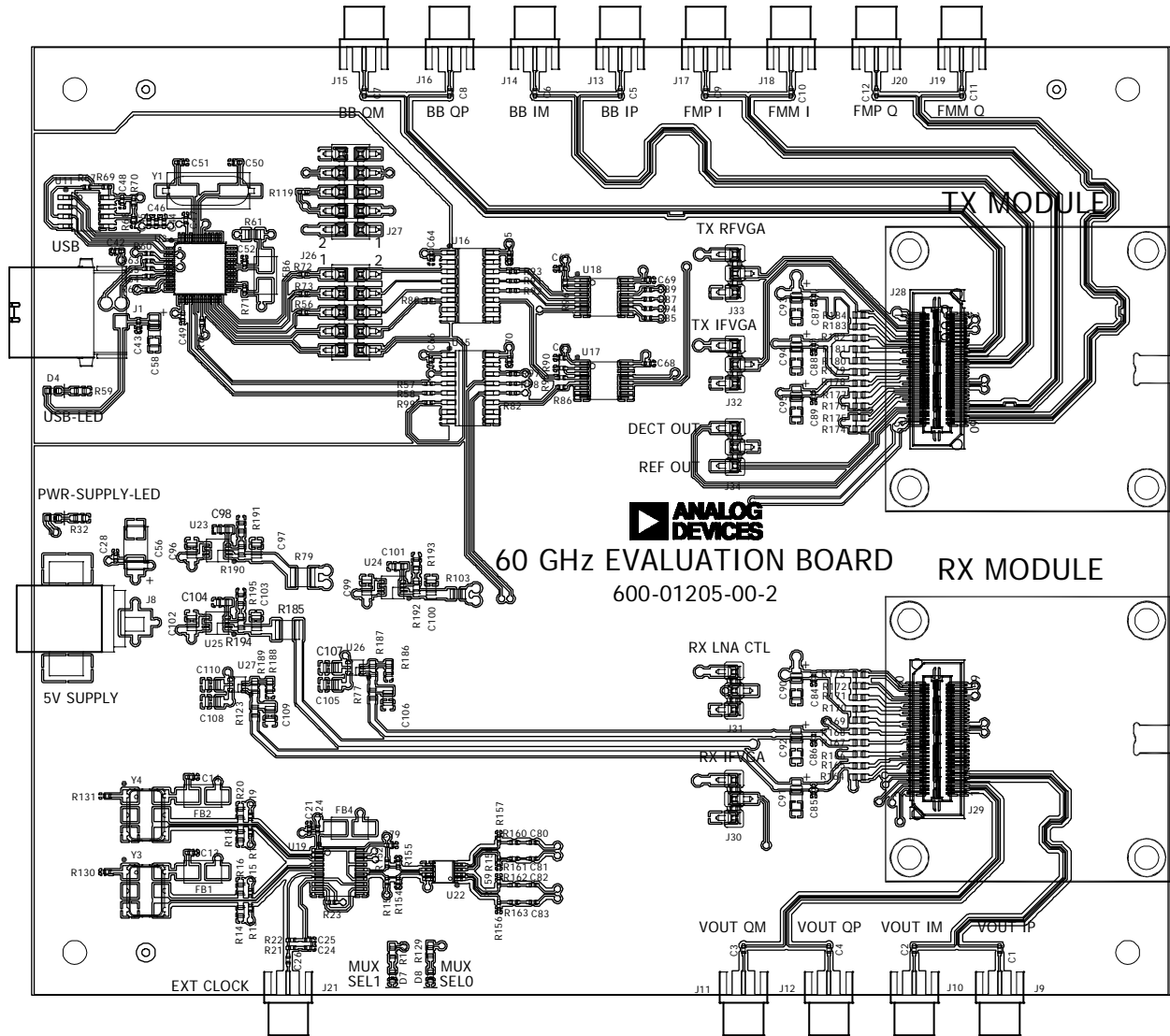

Figure 21. HMC6301 Evaluation PCB Motherboard

14424-021

OUTLINE DIMENSIONS

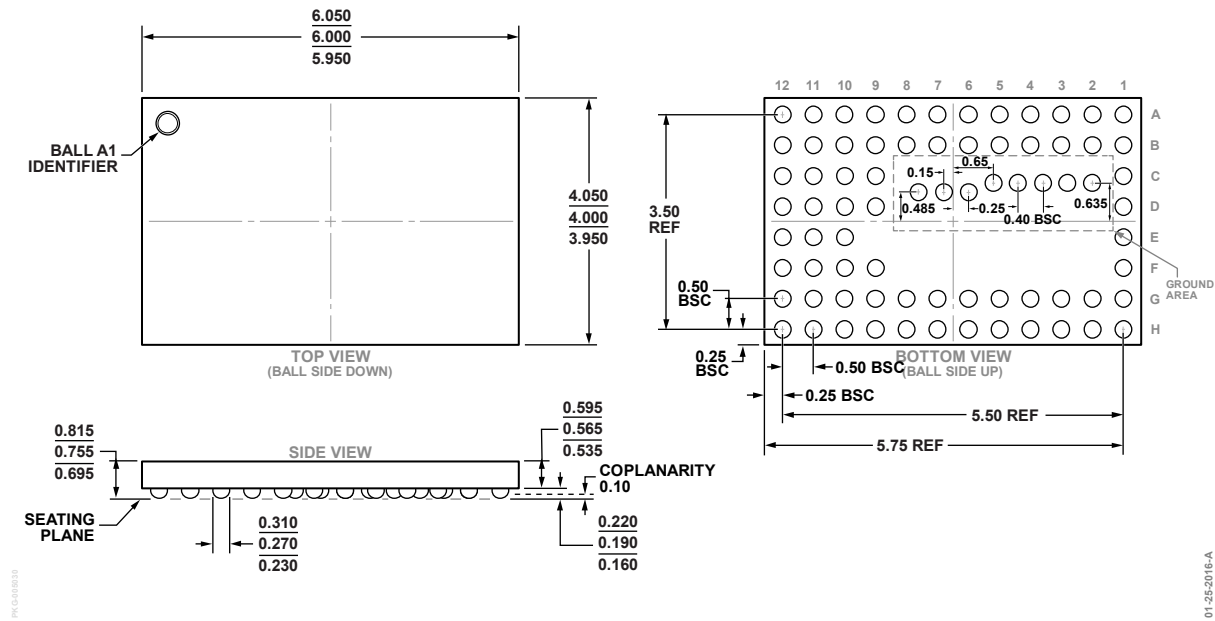

Figure 22. 75-Ball Wafer Level Ball Grid Array [WLBGA] (BF-75-1)
Dimensions shown in millimeters

ORDERING GUIDE

Model	Temperature Range	Chip Bump Composition	MSL Rating ¹	Package Description	Package Option	Package Marking ²
HMC6301BG46	-40°C to +85°C	96.5 Tin (Sn), 3.0 Silver (Ag), 0.5 Copper (Cu)	MSL1	75-Ball WLBGA	BF-75-1	BBFZ #YYWW XXX XXXXX-XX
EV1HMC6301BG46 EK1HMC6350				Evaluation Board, PCB Only Evaluation Kit Assembly		

¹ Maximum peak reflow temperature of 260°C. The peak reflow temperature must not exceed the maximum temperature for which the package is qualified according to the moisture sensitivity level (MSL1).

² BBFZ indicates a Pb-free part, #YYWW indicates the year and week number, and the assembly lot number is indicated by XXX XXXXX-XX.