

GaAs PHEMT MMIC DRIVER AMPLIFIER, 5 - 17 GHz

Typical Applications

The HMC633 is ideal for:

- Point-to-Point Radios
- Point-to-Multi-Point Radios & VSAT
- LO Driver for Mixers
- Military & Space

Features

- Gain: 29 dB
- P1dB: +23 dBm
- Output IP3: +30 dBm
- Saturated Power: +24 dBm @ 27% PAE
- Supply Voltage: +5V @ 180 mA
- 50 Ohm Matched Input/Output
- Die Size: 2.07 x 0.93 x 0.1 mm

Functional Diagram

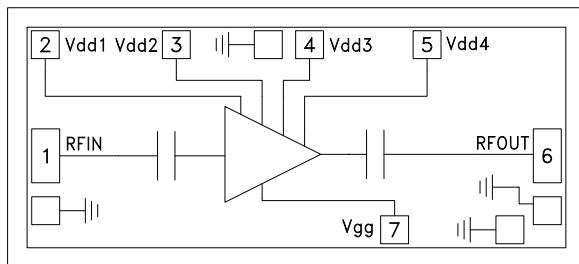

General Description

The HMC633 is a GaAs MMIC PHEMT Driver Amplifier die which operates between 5 and 17 GHz. The amplifier provides up to 31 dB of gain, +30 dBm Output IP3, and +23 dBm of output power at 1 dB gain compression, while requiring 180 mA from a +5V supply. The HMC633 is an ideal driver amplifier for microwave radio applications from 5 to 17 GHz, and may also be biased at +5V, 130 mA to provide 2 dB lower gain with improved PAE. The HMC633 amplifier I/O's are DC blocked and internally matched to 50 Ohms facilitating easy integration into Multi-Chip-Modules (MCMs). All data is taken with die connected at input and output RF ports via one 1 mil wedge bond with minimal length of 0.31 mm (12 mils).

Electrical Specifications, $T_A = +25^\circ\text{C}$, $V_{dd1}, V_{dd2}, V_{dd3}, V_{dd4} = 5\text{V}$, $I_{dd} = 180\text{mA}$ ^[1]

Parameter	Min.	Typ.	Max.	Min.	Typ.	Max.	Units
Frequency Range	5 - 9		9 - 17				GHz
Gain	27	31		26	29		dB
Gain Variation Over Temperature		0.035	0.044		0.040	0.050	dB/°C
Input Return Loss		14			16		dB
Output Return Loss		15			12		dB
Output Power for 1 dB Compression (P1dB)	21	23		21	23		dBm
Saturated Output Power (P _{sat})		24			23.5		dBm
Output Third Order Intercept (IP3)		30			30		dBm
Noise Figure		9			7		dB
Supply Current (I _{dd} = I _{dd1} + I _{dd2} + I _{dd3} + I _{dd4})		180			180		mA

^[1] Adjust V_{gg} between -2 to 0V to achieve I_{dd} = 180mA Typical

GaAs PHEMT MMIC DRIVER AMPLIFIER, 5 - 17 GHz

Broadband Gain & Return Loss

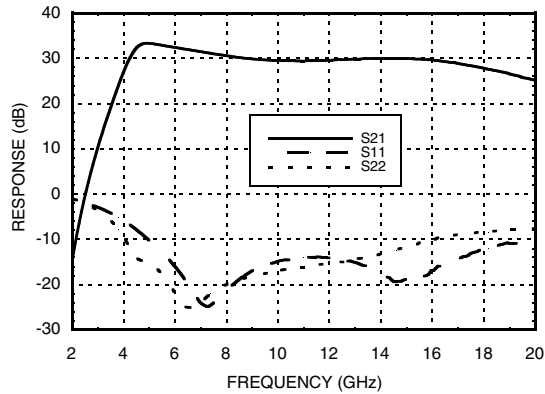

Gain vs. Temperature

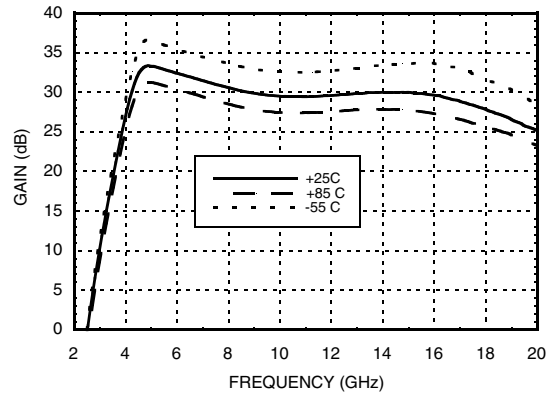

Input Return Loss vs. Temperature

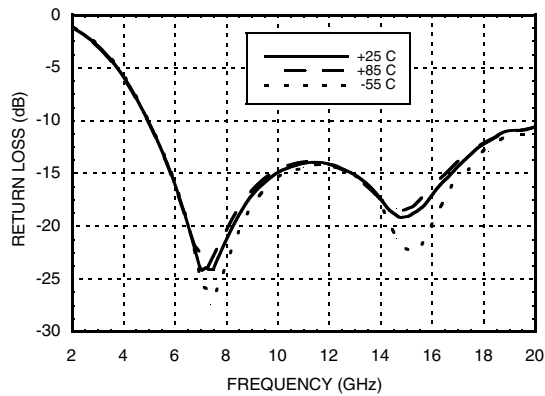

Output Return Loss vs. Temperature

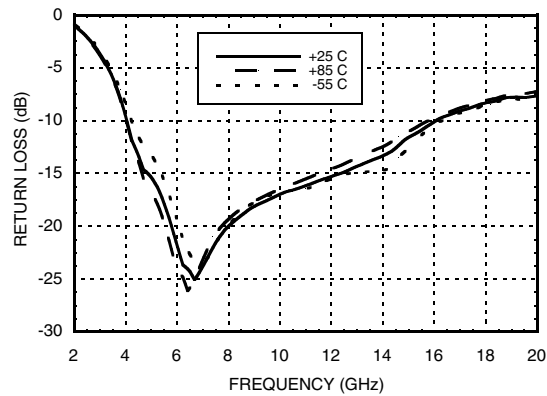

P1dB vs. Temperature

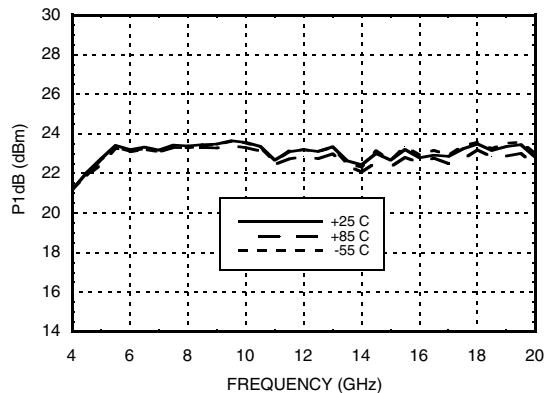

Psat vs. Temperature

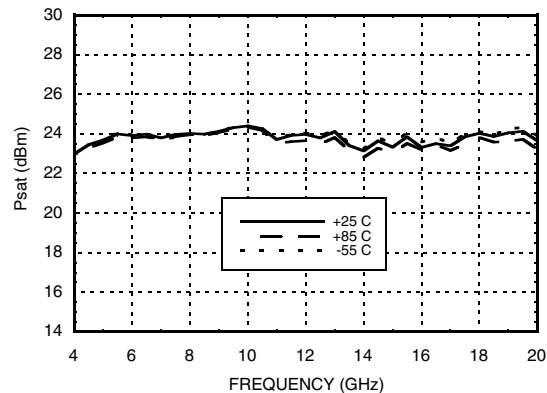

Information furnished by Analog Devices is believed to be accurate and reliable. However, no responsibility is assumed by Analog Devices for its use, nor for any infringements of patents or other rights of third parties that may result from its use. Specifications subject to change without notice. No license is granted by implication or otherwise under any patent or patent rights of Analog Devices. Trademarks and registered trademarks are the property of their respective owners.

For price, delivery, and to place orders: Analog Devices, Inc., One Technology Way, P.O. Box 9106, Norwood, MA 02062-9106 Phone: 781-329-4700 • Order online at www.analog.com Application Support: Phone: 1-800-ANALOG-D

GaAs PHEMT MMIC DRIVER AMPLIFIER, 5 - 17 GHz

Power Compression @ 10 GHz

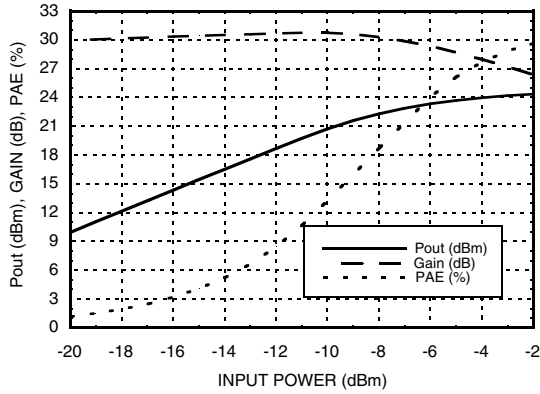

Power Compression @ 17 GHz

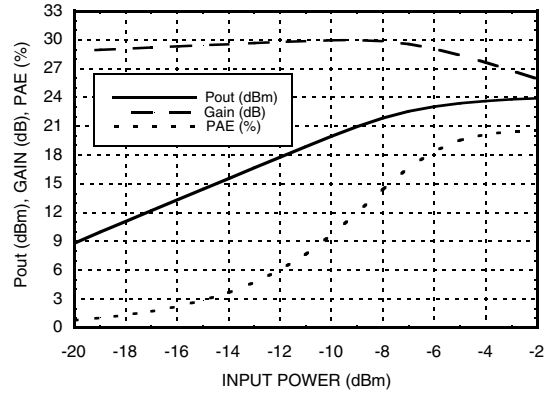

Output IP3 vs. Temperature @ Pin = -15 dBm

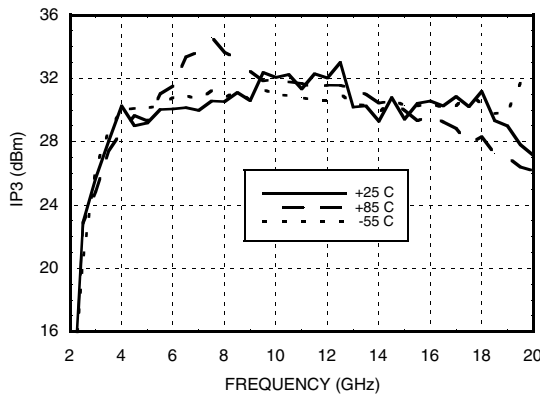

Noise Figure vs. Temperature

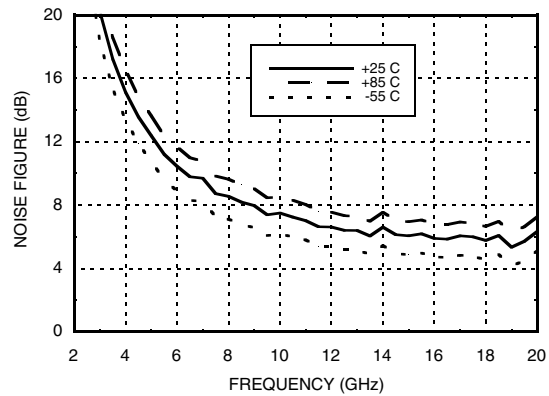

Gain & Power vs. Supply Voltage @ 10 GHz

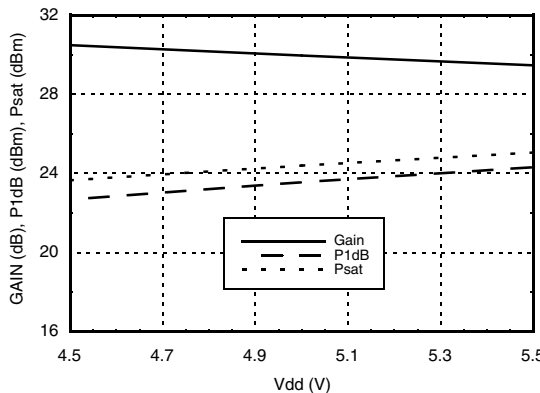

Reverse Isolation vs. Temperature

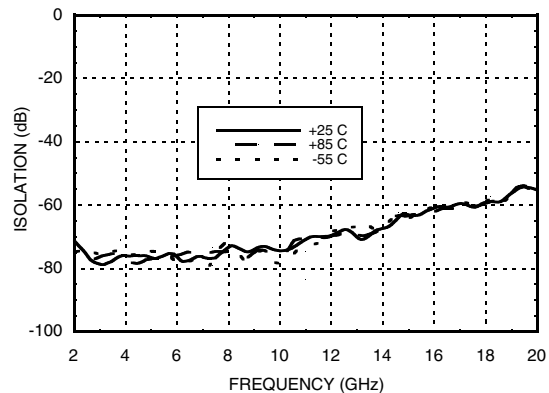

Information furnished by Analog Devices is believed to be accurate and reliable. However, no responsibility is assumed by Analog Devices for its use, nor for any infringements of patents or other rights of third parties that may result from its use. Specifications subject to change without notice. No license is granted by implication or otherwise under any patent or patent rights of Analog Devices. Trademarks and registered trademarks are the property of their respective owners.

For price, delivery, and to place orders: Analog Devices, Inc., One Technology Way, P.O. Box 9106, Norwood, MA 02062-9106 Phone: 781-329-4700 • Order online at www.analog.com Application Support: Phone: 1-800-ANALOG-D

GaAs PHEMT MMIC DRIVER AMPLIFIER, 5 - 17 GHz

Gain, Power & Output IP3 vs. Gate Voltage @ 10 GHz

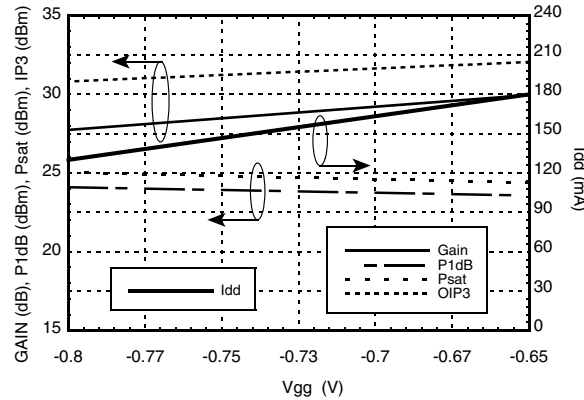

Absolute Maximum Ratings

Drain Bias Voltage (V _{dd1} , V _{dd2} , V _{dd3} , V _{dd4})	+5.5 Vdc
Gate Bias Voltage (V _{gg})	-3 to 0 Vdc
RF Input Power (RFIN)(V _{dd} = +5 Vdc)	+5 dBm
Channel Temperature	175 °C
Continuous P _{diss} (T= 85 °C) (derate 11.76 mW/°C above 85 °C)	1.06 W
Thermal Resistance (channel to die bottom)	85 °C/W
Storage Temperature	-65 to +150 °C
Operating Temperature	-55 to +85 °C

Typical Supply Current vs. V_{dd}

V _{dd} (V)	I _{dd} (mA)
4.5	178
5.0	180
5.5	183

Note: Amplifier will operate over full voltage ranges shown above



**ELECTROSTATIC SENSITIVE DEVICE
OBSERVE HANDLING PRECAUTIONS**

**GaAs PHEMT MMIC DRIVER
AMPLIFIER, 5 - 17 GHz**

Outline Drawing

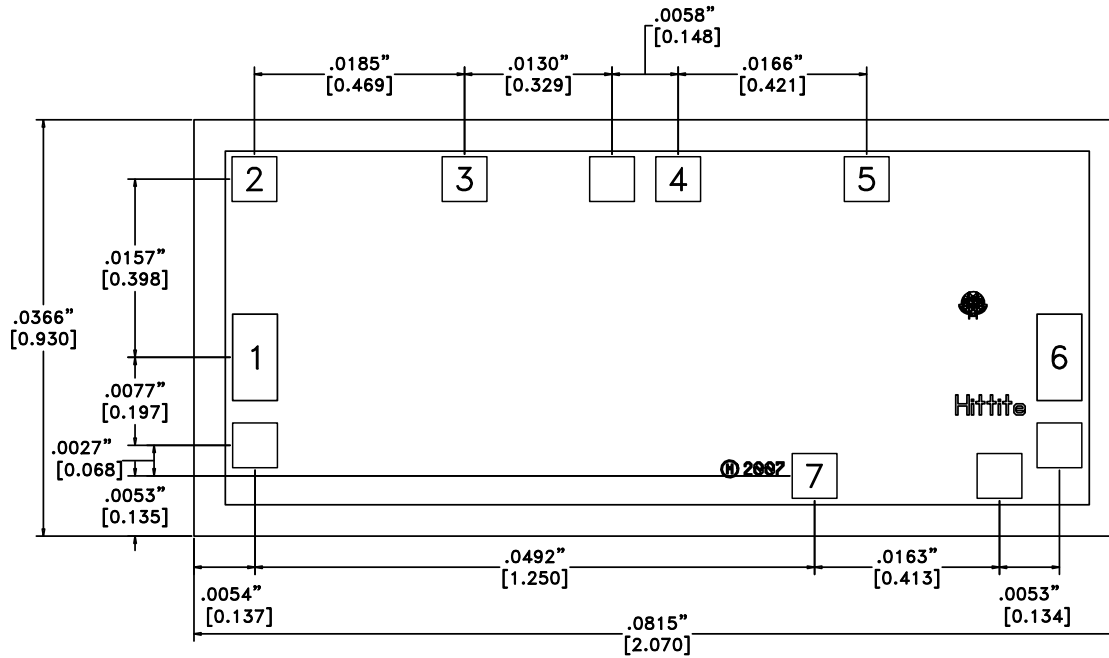

NOTES:

1. ALL DIMENSIONS ARE IN INCHES [MM]
2. DIE THICKNESS IS .004"
3. TYPICAL BOND IS .004" SQUARE
4. BACKSIDE METALLIZATION: GOLD
5. BOND PAD METALLIZATION: GOLD
6. BACKSIDE METAL IS GROUND.
7. CONNECTION NOT REQUIRED FOR UNLABELED BOND PADS.

Die Packaging Information [1]

Standard	Alternate
GP-2 (Gel Pack)	[2]

[1] Refer to the "Packaging Information" section for die packaging dimensions.

[2] For alternate packaging information contact Hittite Microwave Corporation.

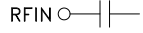
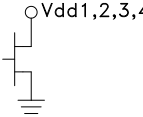
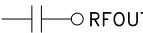
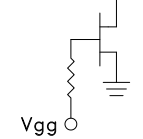
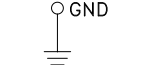

**GaAs PHEMT MMIC DRIVER
AMPLIFIER, 5 - 17 GHz**
Pad Descriptions

Pad Number	Function	Description	Interface Schematic
1	RFIN	This pad is AC coupled and matched to 50 Ohms.	
2, 3, 4, 5	Vdd1, Vdd2, Vdd3, Vdd4	Power Supply Voltage for the amplifier. See assembly diagram for required external components.	
6	RFOUT	This pad is AC coupled and matched to 50 Ohms.	
7	Vgg	Gate control for amplifier, please follow "MMIC Amplifier Biasing Procedure" Application Note. See assembly diagram for required external components.	
Die Bottom	GND	Die bottom must be connected to RF/DC ground.	

**GaAs PHEMT MMIC DRIVER
AMPLIFIER, 5 - 17 GHz**

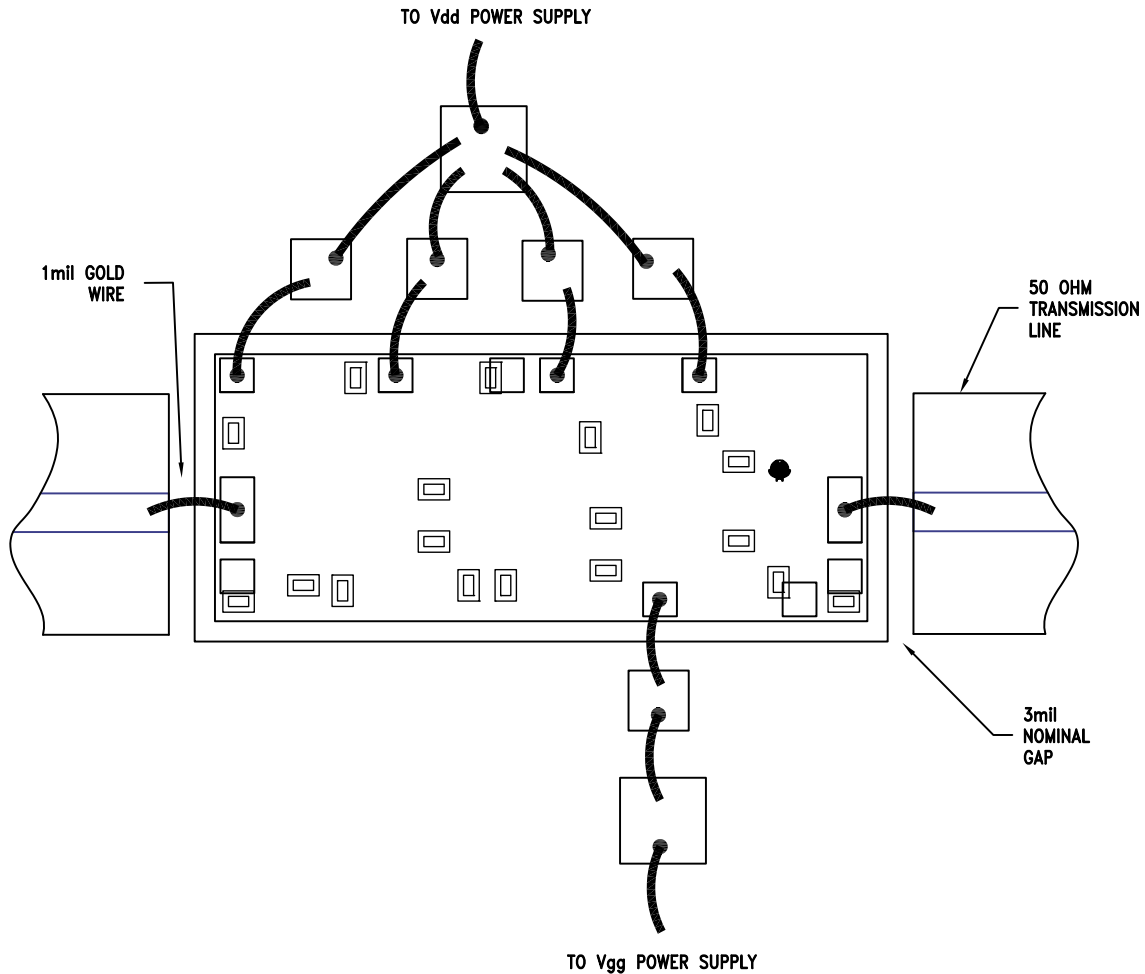
Assembly Diagram



-  0.1 μ F BYPASS CAPACITOR
-  100pF BYPASS CAPACITOR

Information furnished by Analog Devices is believed to be accurate and reliable. However, no responsibility is assumed by Analog Devices for its use, nor for any infringements of patents or other rights of third parties that may result from its use. Specifications subject to change without notice. No license is granted by implication or otherwise under any patent or patent rights of Analog Devices. Trademarks and registered trademarks are the property of their respective owners.

For price, delivery, and to place orders: Analog Devices, Inc., One Technology Way, P.O. Box 9106, Norwood, MA 02062-9106
Phone: 781-329-4700 • Order online at www.analog.com
Application Support: Phone: 1-800-ANALOG-D

GaAs PHEMT MMIC DRIVER AMPLIFIER, 5 - 17 GHz

Mounting & Bonding Techniques for Millimeterwave GaAs MMICs

The die should be attached directly to the ground plane eutectically or with conductive epoxy (see HMC general Handling, Mounting, Bonding Note).

50 Ohm Microstrip transmission lines on 0.127mm (5 mil) thick alumina thin film substrates are recommended for bringing RF to and from the chip (Figure 1). If 0.254mm (10 mil) thick alumina thin film substrates must be used, the die should be raised 0.150mm (6 mils) so that the surface of the die is coplanar with the surface of the substrate. One way to accomplish this is to attach the 0.102mm (4 mil) thick die to a 0.150mm (6 mil) thick molybdenum heat spreader (moly-tab) which is then attached to the ground plane (Figure 2).

Microstrip substrates should be brought as close to the die as possible in order to minimize bond wire length. Typical die-to-substrate spacing is 0.076mm to 0.152 mm (3 to 6 mils).

Handling Precautions

Follow these precautions to avoid permanent damage.

Storage: All bare die are placed in either Waffle or Gel based ESD protective containers, and then sealed in an ESD protective bag for shipment. Once the sealed ESD protective bag has been opened, all die should be stored in a dry nitrogen environment.

Cleanliness: Handle the chips in a clean environment. DO NOT attempt to clean the chip using liquid cleaning systems.

Static Sensitivity: Follow ESD precautions to protect against ESD strikes.

Transients: Suppress instrument and bias supply transients while bias is applied. Use shielded signal and bias cables to minimize inductive pick-up.

General Handling: Handle the chip along the edges with a vacuum collet or with a sharp pair of bent tweezers. The surface of the chip has fragile air bridges and should not be touched with vacuum collet, tweezers, or fingers.

Mounting

The chip is back-metallized and can be die mounted with AuSn eutectic preforms or with electrically conductive epoxy. The mounting surface should be clean and flat.

Eutectic Die Attach: A 80/20 gold tin preform is recommended with a work surface temperature of 255 °C and a tool temperature of 265 °C. When hot 90/10 nitrogen/hydrogen gas is applied, tool tip temperature should be 290 °C. DO NOT expose the chip to a temperature greater than 320 °C for more than 20 seconds. No more than 3 seconds of scrubbing should be required for attachment.

Epoxy Die Attach: Apply a minimum amount of epoxy to the mounting surface so that a thin epoxy fillet is observed around the perimeter of the chip once it is placed into position. Cure epoxy per the manufacturer's schedule.

Wire Bonding

Ball or wedge bond with 0.025mm (1 mil) diameter pure gold wire. Thermosonic wirebonding with a nominal stage temperature of 150 °C and a ball bonding force of 40 to 50 grams or wedge bonding force of 18 to 22 grams is recommended. Use the minimum level of ultrasonic energy to achieve reliable wirebonds. Wirebonds should be started on the chip and terminated on the package or substrate. All bonds should be as short as possible <0.31mm (12 mils).

