

**54 dB, LOGARITHMIC  
DETECTOR / CONTROLLER, 50 - 8000 MHz**

**Typical Applications**

The HMC713LP3E is ideal for:

- Cellular Infrastructure
- WiMAX, WiBro & LTE/4G
- Power Monitoring & Control Circuitry
- Receiver Signal Strength Indication (RSSI)
- Automatic Gain & Power Control
- Military, ECM & Radar

**Features**

- Wide Dynamic Range: up to 54 dB
- High Accuracy:  
±1 dB with 54 dB Range Up To 2.7 GHz
- Fast Output Response Time
- Supply Voltage: +2.7 to +5.5V
- Power-Down Mode
- Excellent Stability over Temperature
- 16 Lead 3x3 mm SMT Package: 9mm<sup>2</sup>

**Functional Diagram**

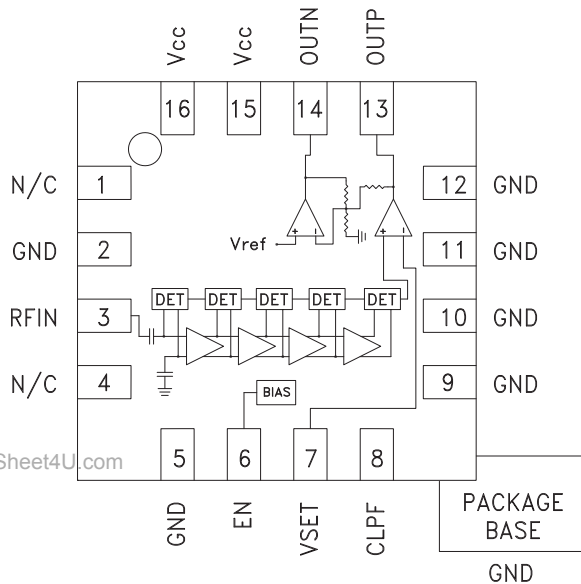

**General Description**

The HMC713LP3E Logarithmic Detector/Controller is ideal for converting the power of RF signals with frequencies in the 50 MHz to 8000 MHz range, to a DC voltage, proportional to input power, at its output. The HMC713LP3E employs a successive compression technology which delivers 54 dB of dynamic range with high measurement accuracy over a wide input frequency range. As the input signal is increased, successive amplifiers move into saturation one by one creating an accurate approximation of the logarithm function. The outputs of a series of detectors are summed, converted into voltage domain and buffered to drive the OUTP output.

For detection mode, the OUTP pin is connected to the VSET input and will provide a nominal logarithmic slope of 17 mV/dB and an intercept of -68 dBm. The HMC713LP3E can also be used in the controller mode where an external voltage is applied to the VSET pin to create an AGC or APC feedback loop.

**Electrical Specifications, T<sub>A</sub> = +25C, Vcc = +3V, EN = +3V [1]**

| Parameter  | Typ.  | Typ.  | Typ.  | Typ.  | Typ.  | Typ.  | Typ.  | Typ.  | Typ.  | Typ.  | Units |
|--|-------|-------|-------|-------|-------|-------|-------|-------|-------|-------|-------|
| Input Frequency  | 50    | 100   | 500   | 900   | 1900  | 2700  | 3900  | 5800  | 7000  | 8000  | MHz   |
| ±3 dB Dynamic Range  | 61    | 61    | 61    | 62    | 62    | 61    | 58    | 50    | 44    | 40    | dB    |
| ±3 dB Dynamic Range Center   | -27   | -27   | -27   | -28   | -28   | -28   | -26   | -23   | -20   | -17   | dBm   |
| ±1 dB Dynamic Range  | 54    | 53    | 53    | 54    | 55    | 54    | 49    | 39    | 33    | 31    | dB    |
| OUTP Slope   | 17.2  | 17.2  | 17.2  | 17.1  | 17    | 17.2  | 18.3  | 21.2  | 23.8  | 25.5  | mV/dB |
| OUTP Intercept   | -67.9 | -68.1 | -68.6 | -68.9 | -69.5 | -69.2 | -65.3 | -55.9 | -48.8 | -44.2 | dBm   |
| Variation of OUTP with Temperature from -40°C to +85°C @ -20 dBm Input | -1.3  | -1.3  | -1.2  | -1.2  | -1.1  | -1.1  | -1.2  | -2.1  | -2.8  | -3.5  | dB    |

[1] Detector mode measurements; OUTP (Pin 13) is connected to VSET (Pin 7) through an RC network.

**54 dB, LOGARITHMIC  
DETECTOR / CONTROLLER, 50 - 8000 MHz**



**Electrical Specifications, (continued)**

| Parameter                         | Conditions   | Min.      | Typ.              | Max.      | Units |
|-----------------------------------|--|-----------|-------------------|-----------|-------|
| <b>Power Down (EN) Input</b>      |  |           |                   |           |       |
| Voltage Range for Normal Mode     |  | 0.8 x Vcc | Vcc/2             |           | V     |
| Voltage Range for Powerdown Mode  |  |           | Vcc/2             | 0.2 x Vcc | V     |
| <b>Power Supply (Vcc)</b>         |  |           |                   |           |       |
| Operating Voltage Range           |  |           | 2.7 - 5.5         |           | V     |
| Supply Current in Normal Mode     | EN Input at Vcc  |           | 17                |           | mA    |
| Supply Current in Power Down Mode | EN Input at GND  |           | 0.4               |           | mA    |
| <b>OUTP Output</b>                |  |           |                   |           |       |
| Rise Time                         | CLPF= 0, No Power to -10 dBm, 10% - 90%  |           | 24                |           | ns    |
| Fall Time                         | CLPF= 0, -10 dBm to No Power, 90% - 10%  |           | 36                |           | ns    |
| Output Video BW                   | 50mV reduction in output voltage swing (3 dB referred to the input) <sup>[1]</sup> |           | 16                |           | MHz   |
| Voltage Range                     | Closed Loop (Eval Board Setup)   |           | 0.2 - 1.2         |           | V     |
| Voltage Range                     | Open Loop  |           | 0.1 to (Vcc -0.1) |           | V     |
| Current Drive Source / Sink       |  |           | 4.2 / 0.48        |           | mA    |
| <b>OUTN Output</b>                |  |           |                   |           |       |
| Current Drive Source / Sink       |  |           | 4.0 / 0.43        |           | mA    |
| Output Voltage Range              |  |           | 0.2 - 2.1         |           | V     |
| <b>RF Input</b>                   |  |           |                   |           |       |
| Input Return Loss (S11)           | F= 50 MHz to 8 GHz<br>Z <sub>0</sub> = 50Ω, See plot                               |           | 10                |           | dB    |
| <b>VSET Input</b>                 |  |           |                   |           |       |
| Input Impedance                   |  |           | 1                 |           | MΩ    |
| Input Voltage Range               | Eval Board   |           | 0.2 - 1.2         |           | V     |
| Low Frequency Gain                | VSET to OUTP   |           | 64                |           | dB    |
| Open Loop Corner Frequency        |  |           | 11                |           | kHz   |

www.DataSheet4U.com

12

POWER DETECTORS - SMT

[1] Two tone test: Frequency = 900 MHz, Tone 1 Power = -20 dBm, Tone 2 Power = -28 dBm



**54 dB, LOGARITHMIC  
DETECTOR / CONTROLLER, 50 - 8000 MHz**

**Output Voltage & Error  
vs. Input Power, Fin = 50 MHz**

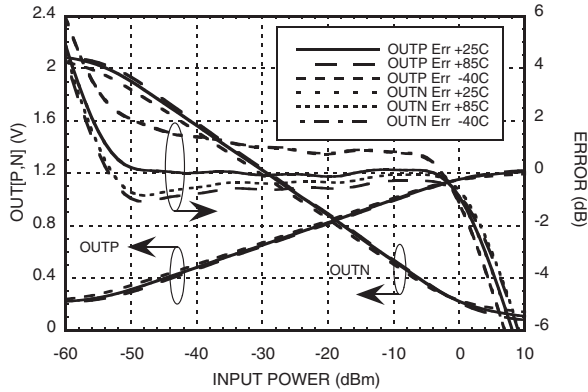

**Output Voltage & Error  
vs. Input Power, Fin = 100 MHz**

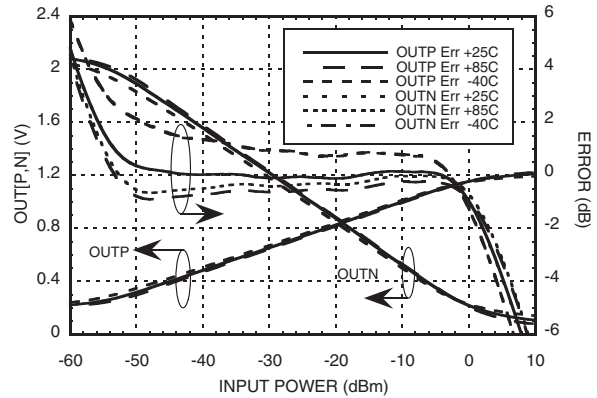

**Output Voltage & Error  
vs. Input Power, Fin = 500 MHz**

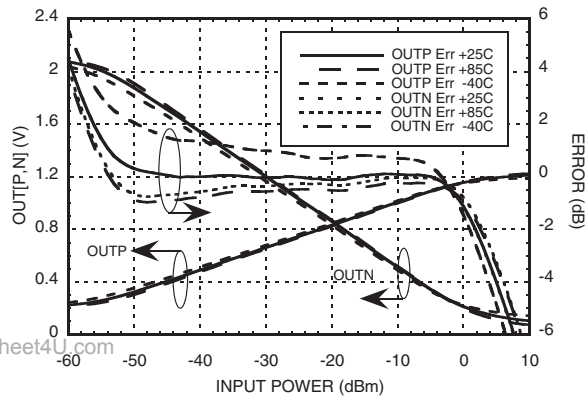

**Output Voltage & Error  
vs. Input Power, Fin = 900 MHz**

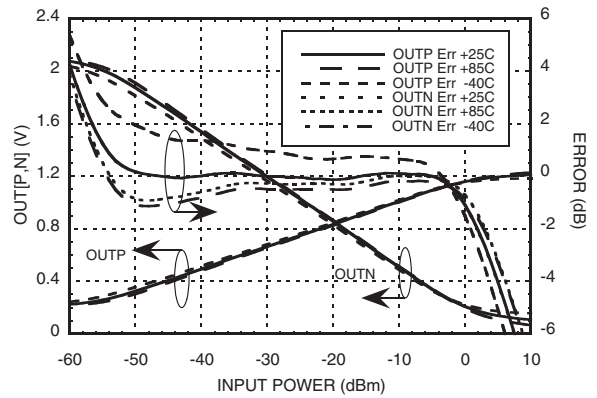

**Output Voltage & Error  
vs. Input Power, Fin = 1900 MHz**

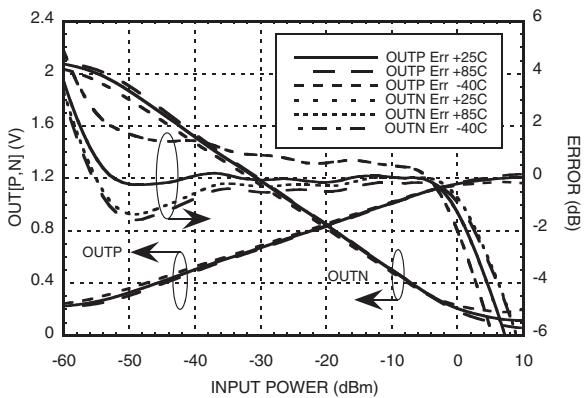

**Output Voltage & Error  
vs. Input Power, Fin = 2700 MHz**

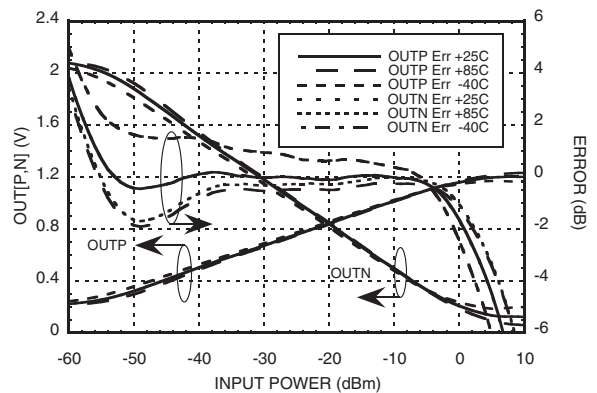

**54 dB, LOGARITHMIC  
DETECTOR / CONTROLLER, 50 - 8000 MHz**



**Output Voltage & Error vs. Input Power, Fin = 3900 MHz**

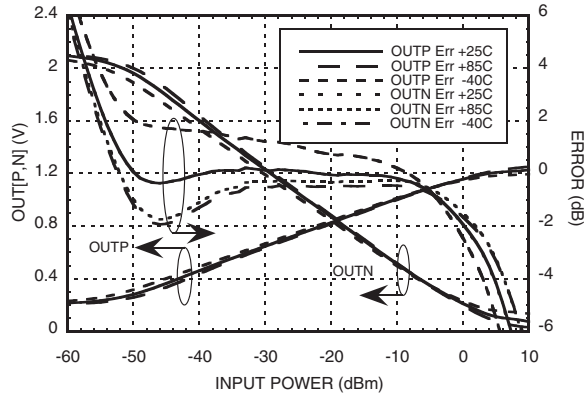

**Output Voltage & Error vs. Input Power, Fin = 5800 MHz**

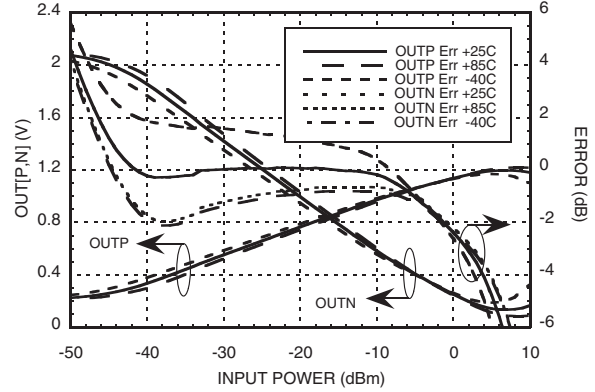

**Output Voltage & Error vs. Input Power, Fin = 7000 MHz**

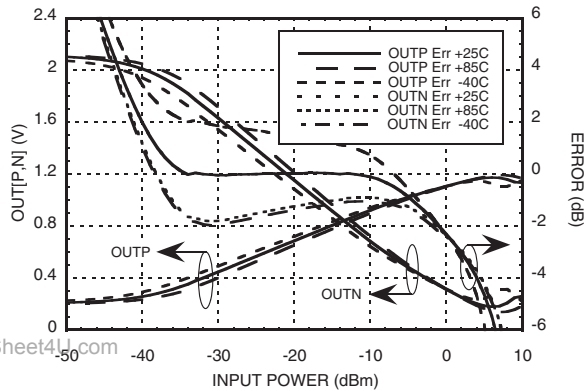

**Output Voltage & Error vs. Input Power, Fin = 8000 MHz**

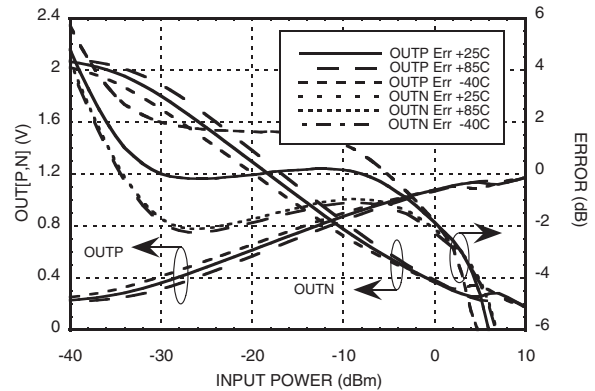

**Input Return Loss**

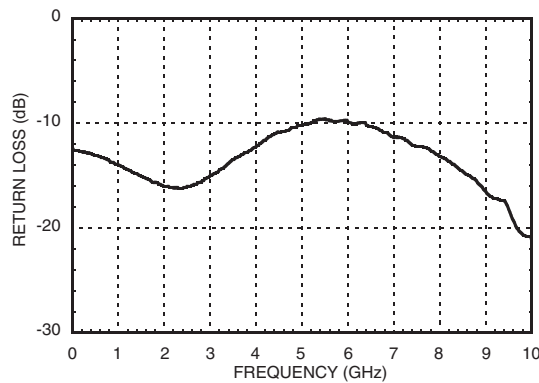



**54 dB, LOGARITHMIC  
DETECTOR / CONTROLLER, 50 - 8000 MHz**

**OUTP Slope vs. Frequency**

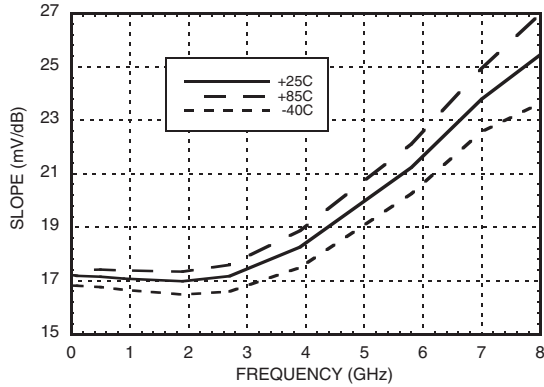

**OUTP Slope vs. Supply Voltage**

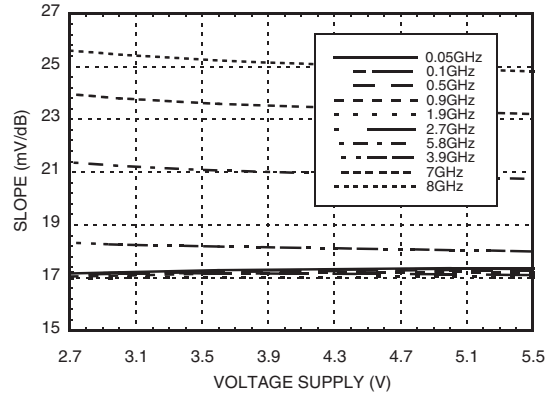

**OUTP Intercept vs. Frequency**

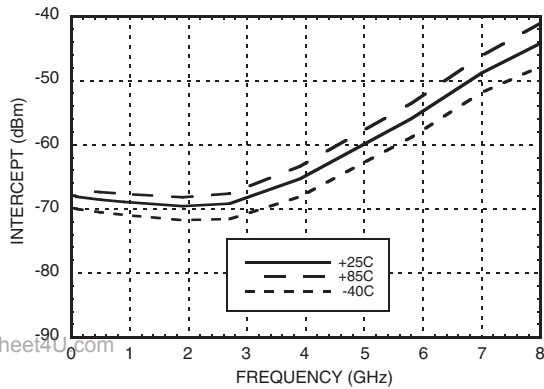

**OUTP Intercept vs. Supply Voltage**

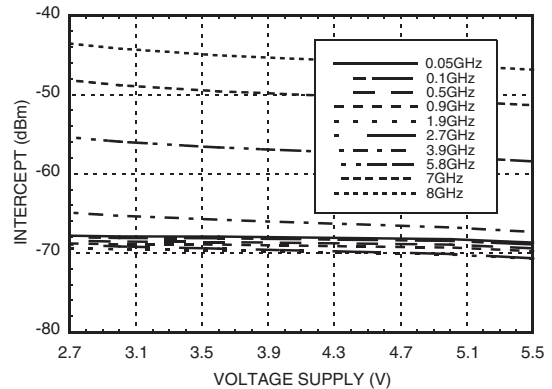

**OUTP vs. Frequency & Input Power**

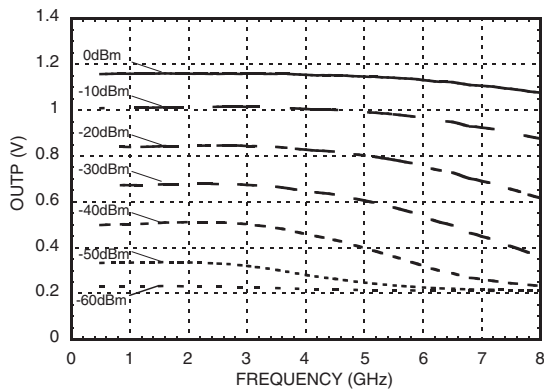

**OUTP Voltage & Error vs. Frequency**

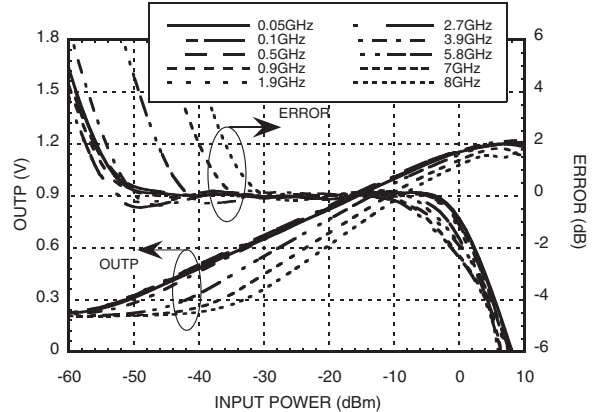

**54 dB, LOGARITHMIC  
DETECTOR / CONTROLLER, 50 - 8000 MHz**



**Output Response [1] Fall Time C1 = Open**

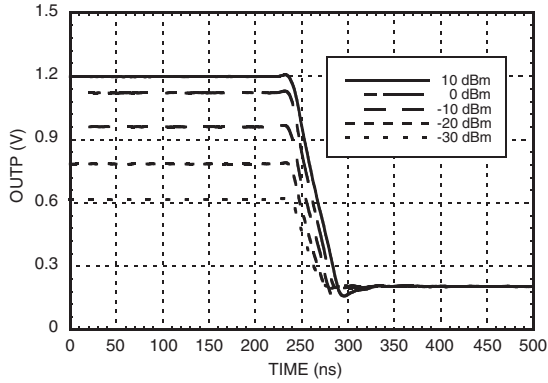

**Output Response Fall Time [1] C1 = 10nF**

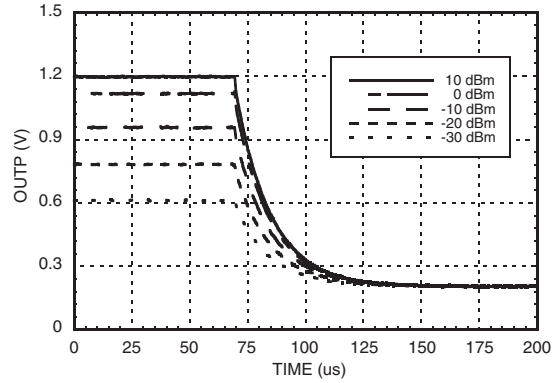

**Output Response Rise Time [1] C1 = Open**

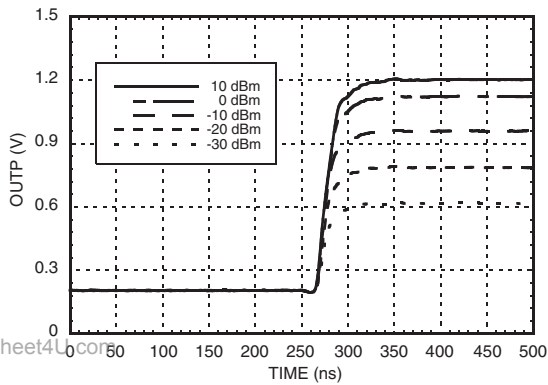

**Output Response Rise Time [1] C1 = 10nF**

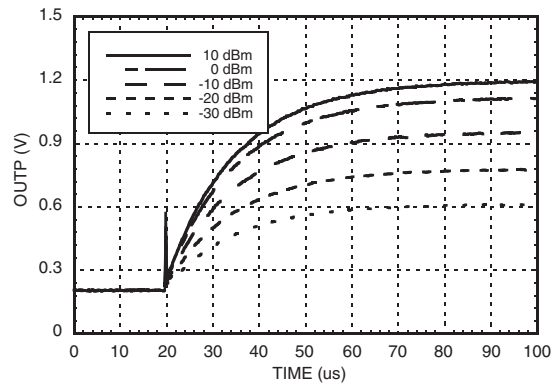

www.DataSheet4U.com

12

POWER DETECTORS - SMT

[1] 900 MHz, Switched CW-Tone



**54 dB, LOGARITHMIC  
DETECTOR / CONTROLLER, 50 - 8000 MHz**

**Absolute Maximum Ratings**

|   |                |
|---|----------------|
| Vcc   | 0 to +5.6V     |
| EN Input Voltage  | 0 to +5.6V     |
| VSET Input Voltage  | 0 to +5.6V     |
| OUTP Output Current   | 5 mA           |
| OUTN Output Current   | 5 mA           |
| RF Input Power  | 12 dBm         |
| Junction Temperature  | 125 °C         |
| Continuous P <sub>diss</sub> (T = 85°C)<br>(Derate 5.43 mW/°C above 85°C) | 0.22 Watts     |
| Thermal Resistance (R <sub>m</sub> )<br>(junction to lead)                | 184 °C/W       |
| Storage Temperature   | -65 to +150 °C |
| Operating Temperature   | -40 to +85 °C  |



**ELECTROSTATIC SENSITIVE DEVICE  
OBSERVE HANDLING PRECAUTIONS**

**Outline Drawing**

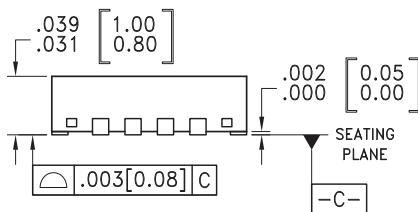
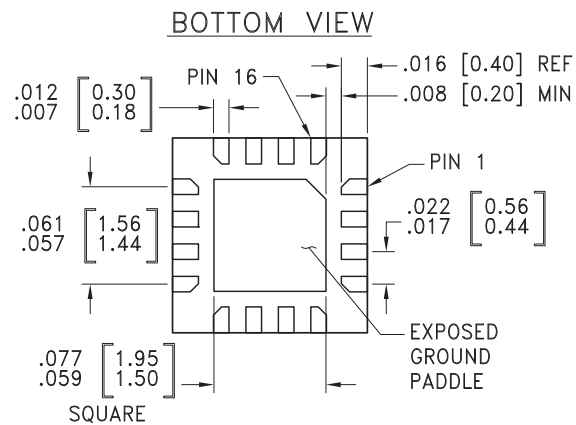
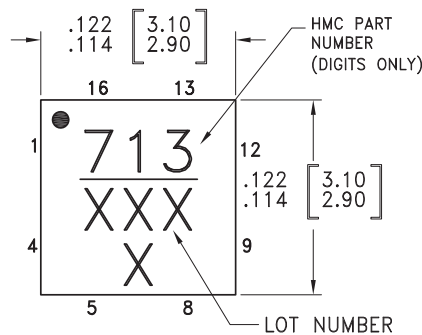

**NOTES:**

- LEADFRAME MATERIAL: COPPER ALLOY
- DIMENSIONS ARE IN INCHES [MILLIMETERS].
- LEAD SPACING TOLERANCE IS NON-CUMULATIVE
- PAD BURR LENGTH SHALL BE 0.15mm MAXIMUM.  
PAD BURR HEIGHT SHALL BE 0.05mm MAXIMUM.
- PACKAGE WARP SHALL NOT EXCEED 0.05mm.
- ALL GROUND LEADS AND GROUND PADDLE MUST BE SOLDERED TO PCB RF GROUND.
- REFER TO HMC APPLICATION NOTE FOR SUGGESTED PCB LAND PATTERN.

**Package Information**

| Part Number | Package Body Material                              | Lead Finish   | MSL Rating          | Package Marking <sup>[1]</sup> |
|-------------|--|---------------|---------------------|--------------------------------|
| HMC713LP3E  | RoHS-compliant Low Stress Injection Molded Plastic | 100% matte Sn | MSL1 <sup>[2]</sup> | <b>713</b><br>XXXX             |

[1] 4-Digit lot number XXXX

[2] Max peak reflow temperature of 260 °C

**54 dB, LOGARITHMIC  
DETECTOR / CONTROLLER, 50 - 8000 MHz**

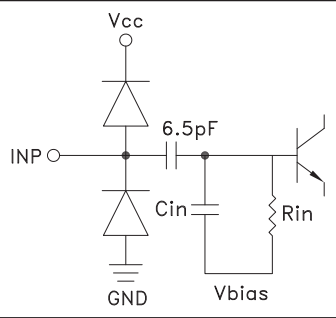
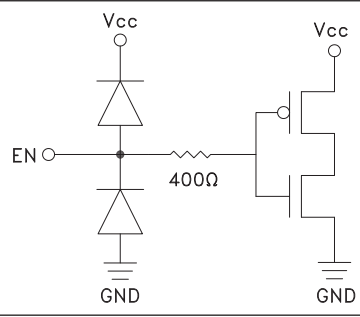
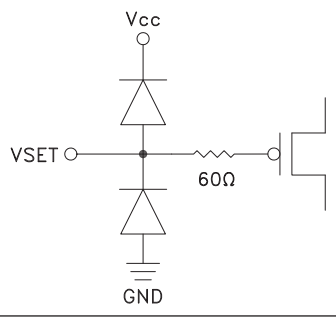
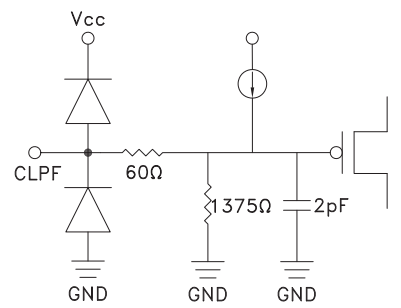

**Pin Descriptions**

| Pin Number   | Function | Description   | Interface Schematic   |
|--------------|----------|---|---|
| 1, 4         | N/C      | These pins are not connected internally.  |   |
| 2, 5, 9 - 12 | GND      | These pins and package bottom must be connected to RF/DC ground.  |    |
| 3            | RFIN     | RF input pin.   |    |
| 6            | EN       | Enable pin.<br>Apply VEN > 0.8 x Vcc for normal operation.<br>Apply VEN < 0.2xVcc to disable the HMC713LP3E and reduce supply current to 0.4mA. |   |
| 7            | VSET     | Set point input for controller mode.<br>Connect to OUTP with the resistor network shown in evaluation board drawing for detector mode.          |  |
| 8            | CLPF     | Connection for ground referenced external lowpass filter capacitor.   |  |

www.DataSheet4U.com

12

POWER DETECTORS - SMT





**54 dB, LOGARITHMIC  
DETECTOR / CONTROLLER, 50 - 8000 MHz**

**Pin Descriptions (Continued)**

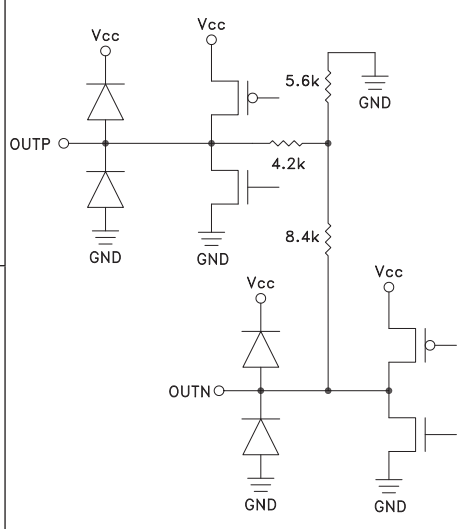
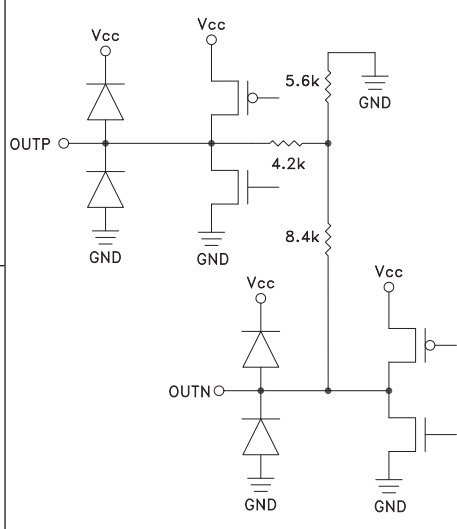
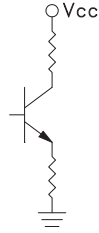
| Pin Number | Function | Description   | Interface Schematic   |
|------------|----------|---|---|
| 13         | OUTP     | Logarithmic output that converts the input power to a DC level in controller mode. Output voltage increases with increasing amplitude |     |
| 14         | OUTN     | Inverted logarithmic output.<br>$OUTN = 2.55 - 2 \times OUTP$   |     |
| 15, 16     | Vcc      | Bias Supply. Connect supply voltage to these pins with appropriate filtering.   |  |

www.DataSheet4U.com

**54 dB, LOGARITHMIC  
DETECTOR / CONTROLLER, 50 - 8000 MHz**



**Application & Evaluation PCB Schematic**

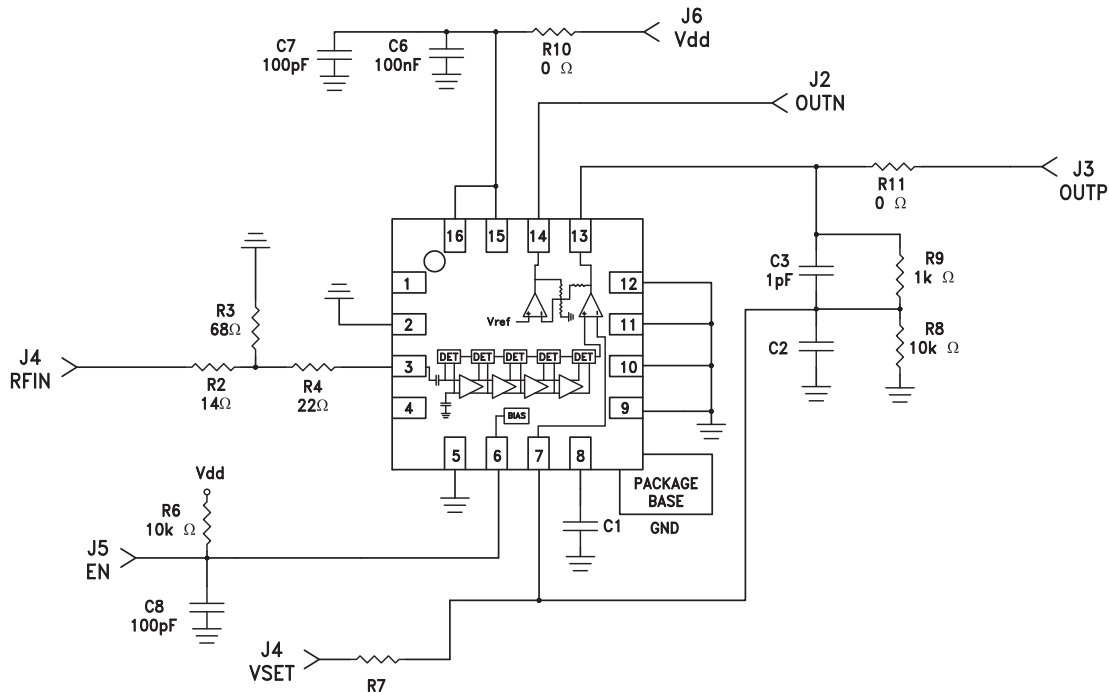

**Notes**

Note 1: The HMC713LP3E evaluation board is pre-assembled for single-ended input, and detector/RSSI mode.

Note 2: For detector mode, connect high impedance volt meter to the OUTP / OUTN port.

Note 3: For controller mode, remove R9 & C3 and install 1kΩ resistor (R7, not included) and 100pF capacitor (C2, not included), then make appropriate connection to OUTP and VSET. In controller mode, the OUTP / OUTN output can be used to drive a variable gain amplifier, or a variable attenuator, either directly or through a buffer or microcontroller. VSET should be connected to an external supply, typically between +0.2 and +1.2V.

Note 4: An external capacitance C1 can be connected to CLPF port for additional filtering of OUTP and OUTN outputs..

## 54 dB, LOGARITHMIC DETECTOR / CONTROLLER, 50 - 8000 MHz



### Evaluation PCB

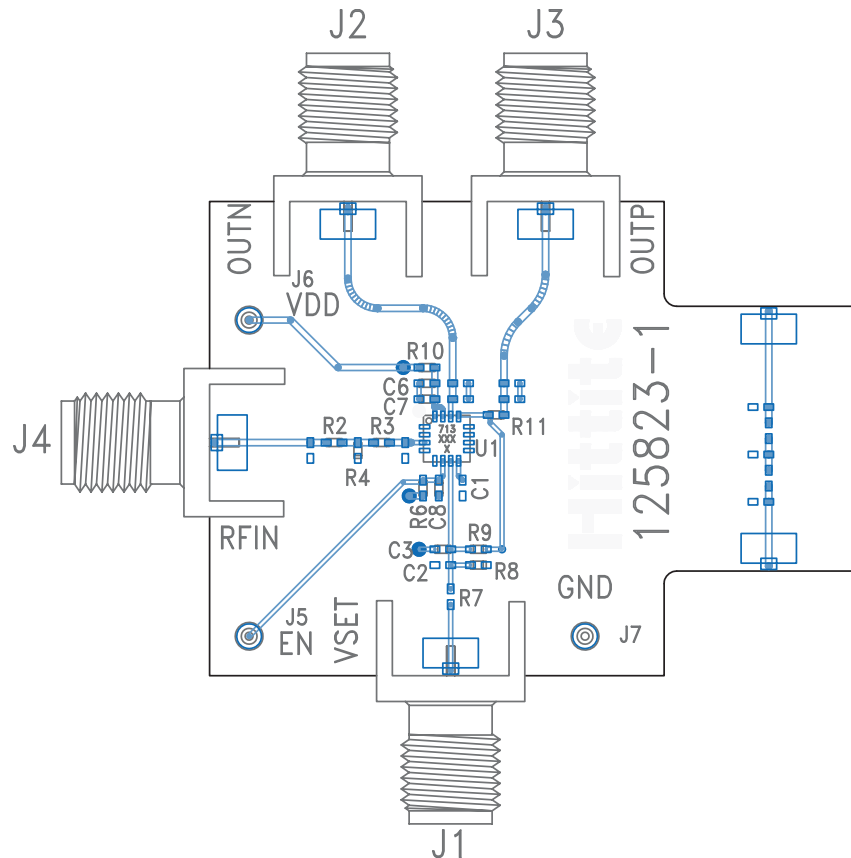

### List of Materials for Evaluation PCB 125825 [1]

| Item     | Description                      |
|----------|----------------------------------|
| J1 - J4  | PC Mount SMA Connector           |
| J5 - J7  | DC Pin                           |
| C3       | 1 pF Capacitor, 0402 Pkg.        |
| C6       | 0.1 $\mu$ F Capacitor, 0402 Pkg. |
| C7, C8   | 100 pF Capacitor, 0402 Pkg.      |
| R2       | 14 $\Omega$ Resistor, 0402 Pkg.  |
| R3       | 68 $\Omega$ Resistor, 0402 Pkg.  |
| R4       | 22 $\Omega$ Resistor, 0402 Pkg.  |
| R6, R8   | 10k $\Omega$ Resistor, 0402 Pkg. |
| R9       | 1k $\Omega$ Resistor, 0402 Pkg.  |
| R10, R11 | 0 $\Omega$ Resistor, 0402 Pkg.   |
| U1       | HMC713LP3E Logarithmic Amplifier |
| PCB [2]  | 125823 Evaluation PCB            |

[1] Reference this number when ordering complete evaluation PCB

[2] Circuit Board Material: Arlon 25FR or Rogers 4350

The circuit board used in the final application should use RF circuit design techniques. Signal lines should have 50 ohm impedance while the package ground leads and exposed paddle should be connected directly to the ground plane similar to that shown. A sufficient number of via holes should be used to connect the top and bottom ground planes. The evaluation circuit board shown is available from Hittite upon request.

**54 dB, LOGARITHMIC  
DETECTOR / CONTROLLER, 50 - 8000 MHz**



**Notes:**