

## GAAS PHEMT MMIC LOW NOISE AMPLIFIER, 4.8 - 6.0 GHz

### Typical Applications

The HMC717ALP3E is ideal for:

- Fixed Wireless and LTE/WiMAX/4G
- BTS & Infrastructure
- Repeaters and Femtocells
- Public Safety Radio
- Access Points

### Features

Noise Figure: 1.1 dB

Gain: 14.5 dB

Output IP3: +29.5 dBm

Single Supply: +3V to +5V

16 Lead 3x3mm QFN Package: 9 mm<sup>2</sup>

### Functional Diagram

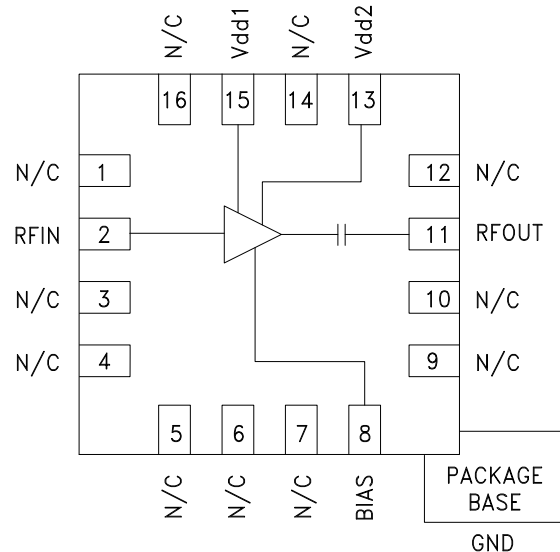

### General Description

The HMC717ALP3E is a GaAs PHEMT MMIC Low Noise Amplifier that is ideal for fixed wireless and LTE/WiMAX/4G basestation front-end receivers operating between 4.8 and 6.0 GHz. The amplifier has been optimized to provide 1.1 dB noise figure, 14.5 dB gain and +29.5 dBm output IP3 from a single supply of +5V. Input and output return losses are excellent and the LNA requires minimal external matching and bias decoupling components. The HMC717ALP3E can be biased with +3V to +5V and features an externally adjustable supply current which allows the designer to tailor the linearity performance of the LNA for each application.

### Electrical Specifications

$T_A = +25^\circ\text{C}$ ,  $R_{bias} = 825\text{ Ohms}$  for  $V_{dd} = 5V$ ,  $R_{bias} = 5.76k\text{ Ohms}$  for  $V_{dd} = 3V$  [1] [2]

Parameter	Vdd = +3V			Vdd = +5V			Units
	Min.	Typ.	Max.	Min.	Typ.	Max.	
Frequency Range	4.8 - 6.0			4.8 - 6.0			GHz
Gain		12.5		11.0	14.5		dB
Gain Variation Over Temperature		0.005			0.01		dB/°C
Noise Figure		1.3			1.3	1.8	dB
Input Return Loss		8			9		dB
Output Return Loss		13			15		dB
Output Power for 1 dB Compression (P1dB)		12			18		dBm
Saturated Output Power (Psat)		14.5			19		dBm
Output Third Order Intercept (IP3)		23.5			29.5		dBm
Total Supply Current (Idd)		31			68	100	mA

[1] Rbias resistor sets current, see application circuit herein

[2] Vdd = Vdd1 = Vdd2

**GAAS PHEMT MMIC LOW NOISE AMPLIFIER, 4.8 - 6.0 GHz**

**Broadband Gain & Return Loss [1][2]**

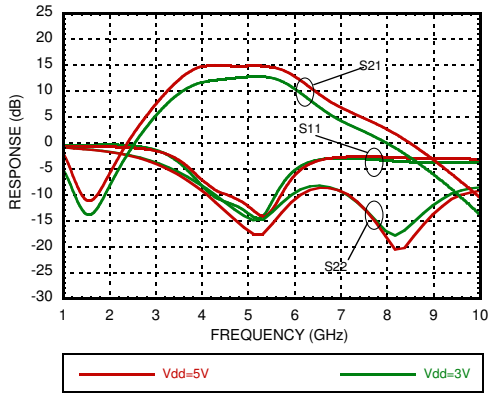

**Gain vs. Temperature [1]**

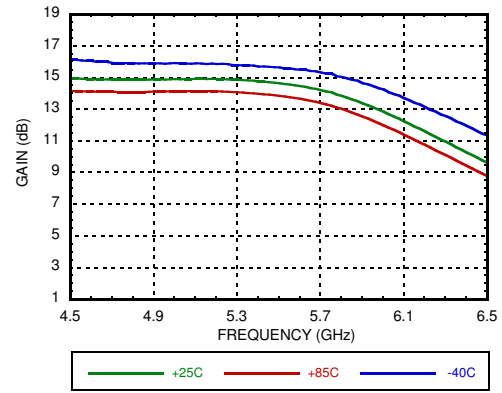

**Gain vs. Temperature [2]**

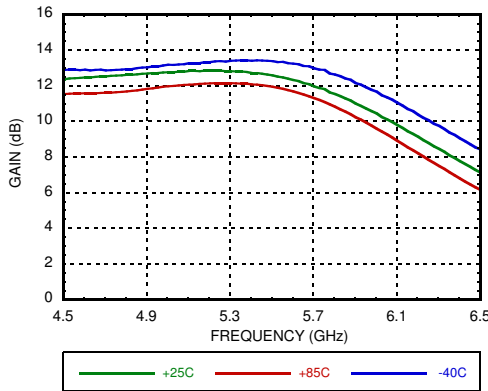

**Input Return Loss vs. Temperature [1]**

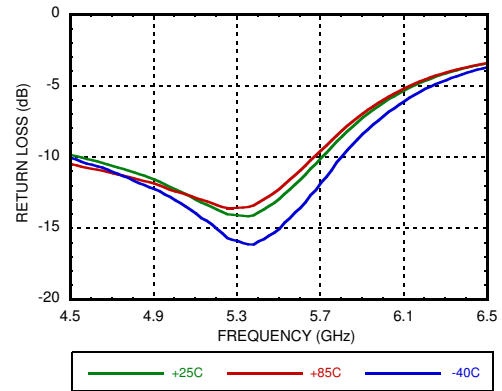

**Output Return Loss vs. Temperature [1]**

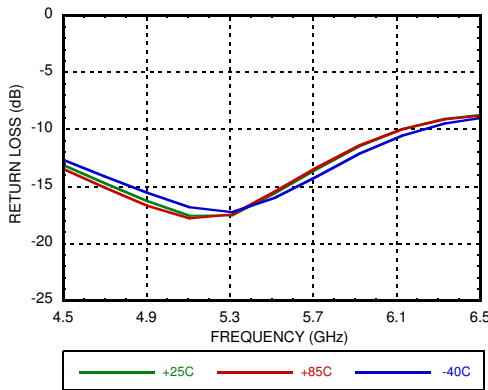

**Reverse Isolation vs. Temperature [1]**

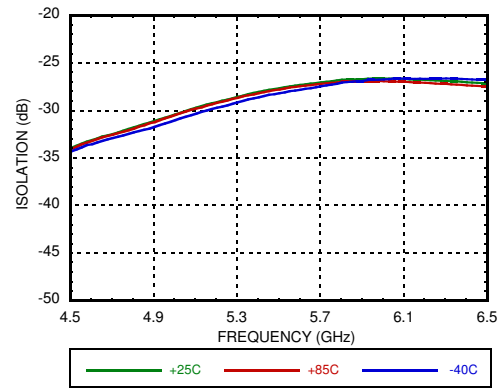

[1] Vdd = 5V, Rbias = 825Ω [2] Vdd = 3V, Rbias = 5.76kΩ

**GAAS PHEMT MMIC LOW NOISE AMPLIFIER, 4.8 - 6.0 GHz**

AMPLIFIER - LOW NOISE - SMT

**Noise Figure vs. Temperature [1] [2]**

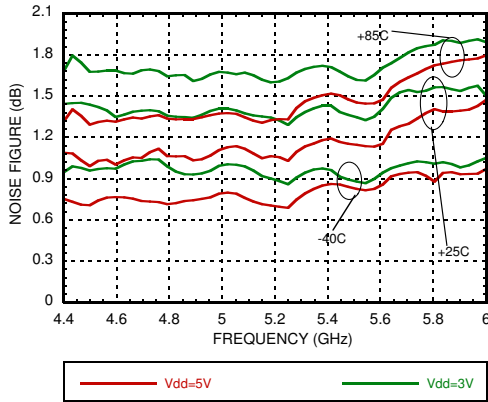

**P1dB vs. Temperature [1] [2]**

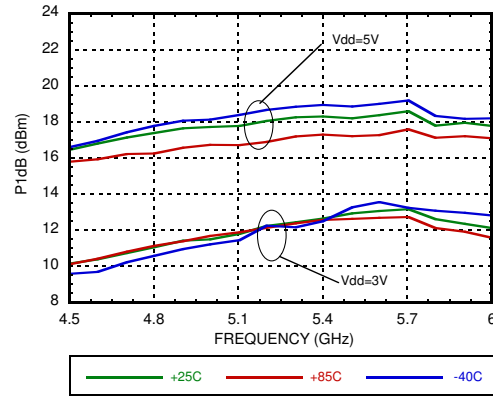

**Psat vs. Temperature [1] [2]**

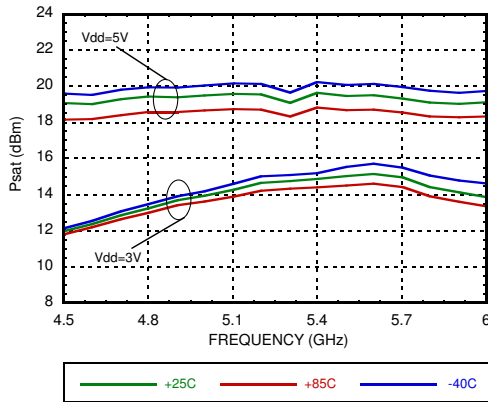

**Output IP3 vs. Temperature [1] [2]**

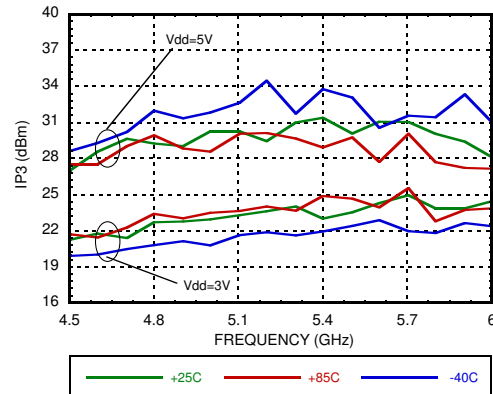

**Output IP3 and Total Supply Current vs. Supply Voltage @ 4800 MHz [3]**

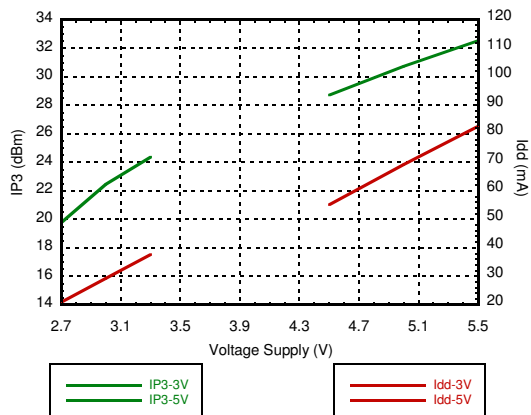

**Output IP3 and Total Supply Current vs. Supply Voltage @ 5900 MHz [3]**

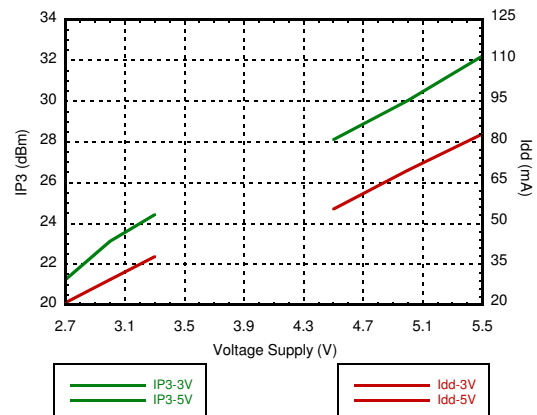

[1] Vdd = 5V, Rbias = 825Ω [2] Vdd = 3V, Rbias = 5.76kΩ  
 [3] Rbias = 825Ω for Vdd = 5V, Rbias = 5.76kΩ for Vdd = 3V

**GAAS PHEMT MMIC LOW NOISE AMPLIFIER, 4.8 - 6.0 GHz**

**Power Compression @ 4800 MHz [1]**

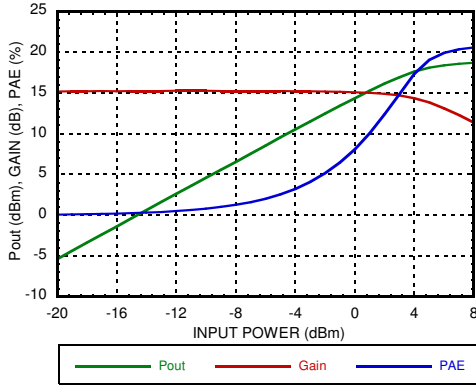

**Power Compression @ 4800 MHz [2]**

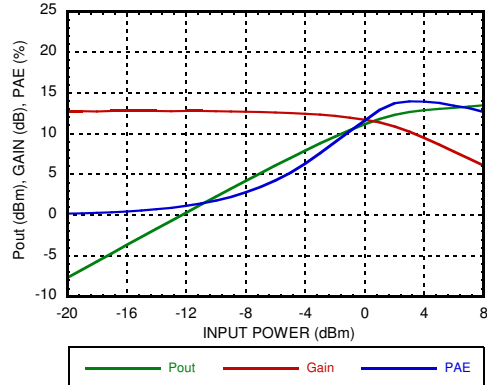

**Power Compression @ 5900 MHz [1]**

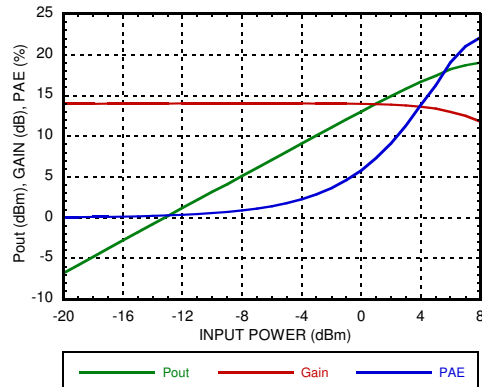

**Power Compression @ 5900 MHz [2]**

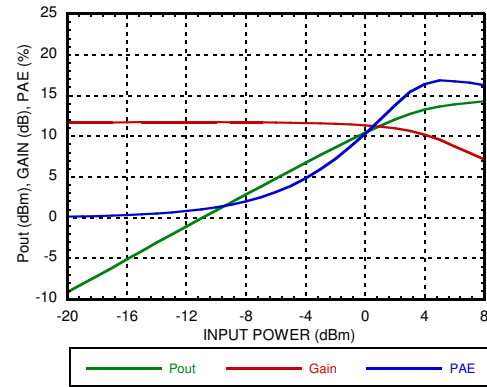

**Gain, Power & Noise Figure vs. Supply Voltage @ 4800 MHz [3]**

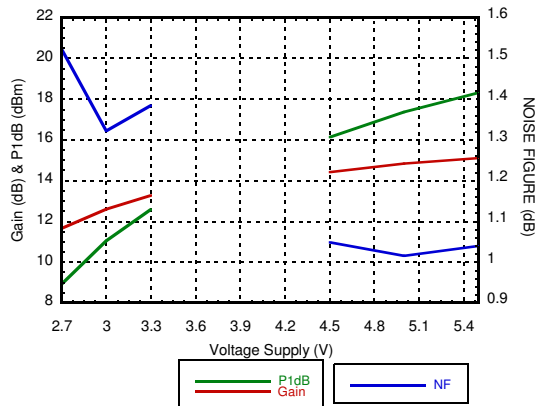

**Gain, Power & Noise Figure vs. Supply Voltage @ 5900 MHz [3]**

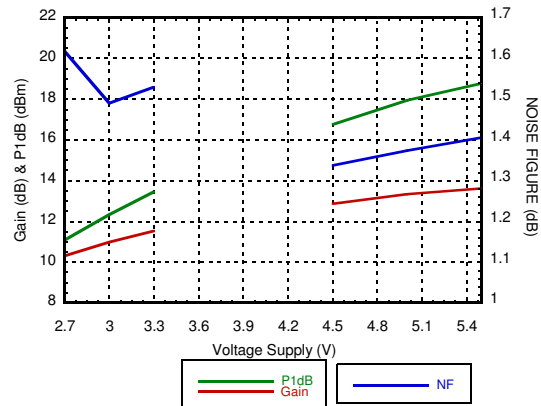

[1] Vdd = 5V, Rbias = 825Ω [2] Vdd = 3V, Rbias = 5.76kΩ [3] Rbias = 825Ω for Vdd = 5V, Rbias = 5.76kΩ for Vdd = 3V

**GAAS PHEMT MMIC LOW NOISE  
AMPLIFIER, 4.8 - 6.0 GHz**

**Output IP3 vs. Rbias @ 4800 MHz**

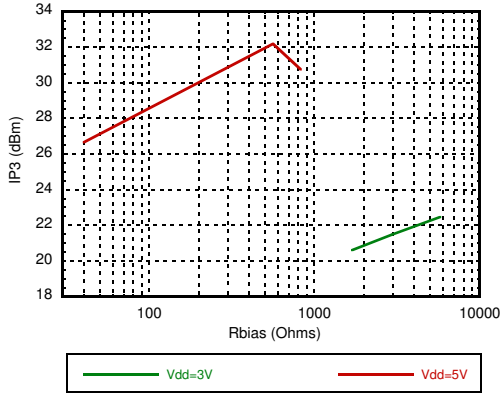

**Gain, Noise Figure & Rbias @ 4800 MHz**

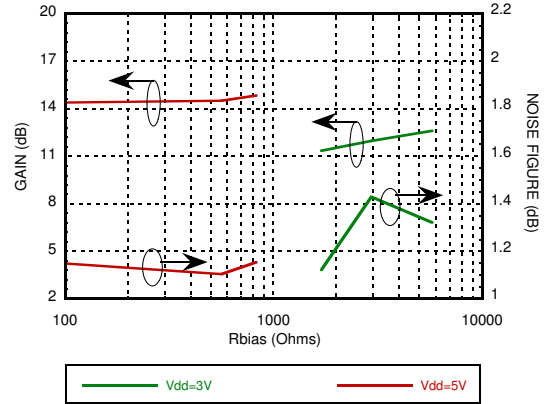

**Output IP3 vs. Rbias @ 5900 MHz**

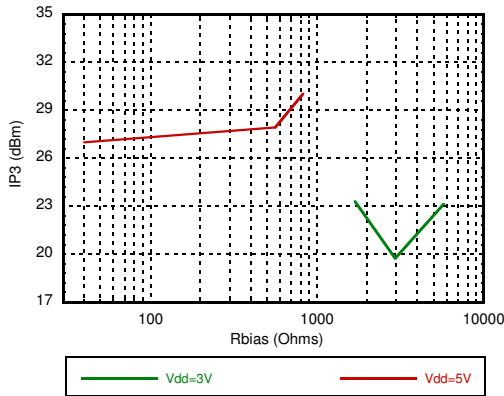

**Gain, Noise Figure & Rbias @ 5900 MHz**

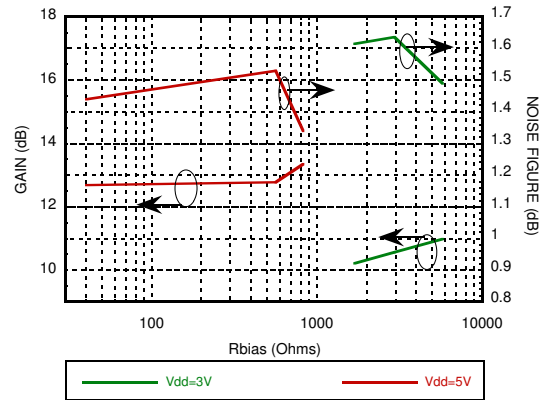

## GAAS PHEMT MMIC LOW NOISE AMPLIFIER, 4.8 - 6.0 GHz

### Absolute Bias Resistor Range & Recommended Bias Resistor Values

Vdd (V)	Rbias (Ohms)			Idd (mA)
	Min	Max	Recommended	
3V	1.69k <sup>[1]</sup>	Open Circuit	1.69k	20
			2.94k	26
			5.76k	30
5V	40 <sup>[2]</sup>	Open Circuit	40.2	48.4
			562	65.5
			825	72

[1] With Vdd= 3V and Rbias < 1.69kΩ may result in the part becoming conditionally stable which is not recommended.

[2] With Vdd = 5V and Rbias<40Ω may result in the part becoming conditionally stable which is not recommended.

### Absolute Maximum Ratings

Drain Bias Voltage (Vdd)	+5.5V
RF Input Power (RFIN) (Vdd = +5 Vdc)	+20 dBm
Channel Temperature	150 °C
Continuous P <sub>diss</sub> (T= 85 °C) (derate 8.0 mW/°C above 85 °C)	0.52 W
Thermal Resistance (channel to ground paddle)	125 °C/W
Storage Temperature	-65 to +150 °C
Operating Temperature	-40 to +85 °C
ESD Sensitivity (HBM)	Class 1A



ELECTROSTATIC SENSITIVE DEVICE  
OBSERVE HANDLING PRECAUTIONS

### Typical Supply Current vs. Supply Voltage

Rbias	Vdd (V)	Idd (mA)
5.76K	2.7	20
	3.0	31
	3.3	39
825	4.5	57
	5.0	72
	5.5	86

Note: Amplifier will operate over full voltage ranges shown above.

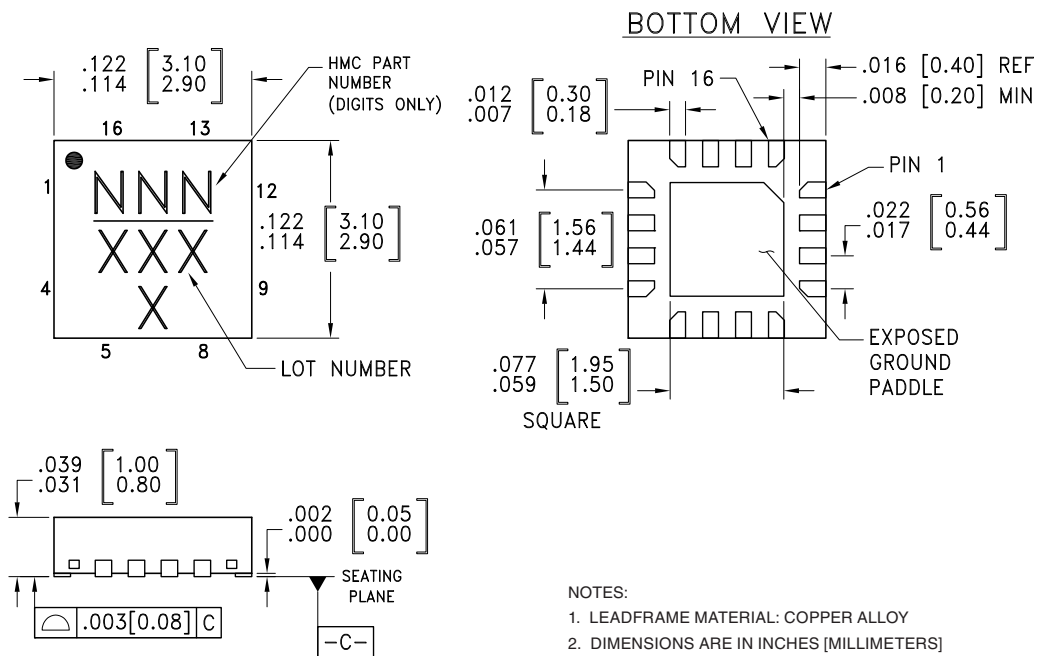
**GAAS PHEMT MMIC LOW NOISE  
AMPLIFIER, 4.8 - 6.0 GHz**
**Outline Drawing**

**NOTES:**

1. LEADFRAME MATERIAL: COPPER ALLOY
2. DIMENSIONS ARE IN INCHES [MILLIMETERS]
3. LEAD SPACING TOLERANCE IS NON-CUMULATIVE
4. PAD BURR LENGTH SHALL BE 0.15mm MAXIMUM.  
PAD BURR HEIGHT SHALL BE 0.05mm MAXIMUM.
5. PACKAGE WARP SHALL NOT EXCEED 0.05mm.
6. ALL GROUND LEADS AND GROUND PADDLE MUST BE SOLDERED TO PCB RF GROUND.
7. REFER TO HITTITE APPLICATION NOTE FOR SUGGESTED LAND PATTERN.

**Package Information**

Part Number	Package Body Material	Lead Finish	MSL Rating	Package Marking <sup>[3]</sup>
HMC717ALP3E	RoHS-compliant Low Stress Injection Molded Plastic	100% matte Sn	MSL3 <sup>[2]</sup>	717A XXXX



[1] Max peak reflow temperature of 235 °C

[2] Max peak reflow temperature of 260 °C

[3] 4-Digit lot number XXXX

## GAAS PHEMT MMIC LOW NOISE AMPLIFIER, 4.8 - 6.0 GHz

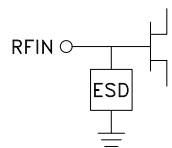
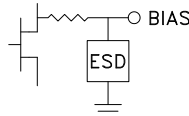
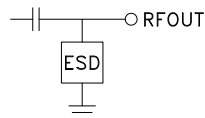
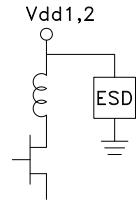
### Pin Descriptions

Pin Number	Function	Description	Interface Schematic
1, 3 - 7, 9, 10, 12, 14, 16	N/C	No connection required. These pins may be connected to RF/DC ground without affecting performance.	
2	RFIN	This pin is DC coupled See the application circuit for off-chip component.	
8	BIAS	This pin is used to set the DC current of the amplifier by selection of the external bias resistor. See application circuit.	
11	RFOUT	This pin is AC coupled and matched to 50 Ohms	
13, 15	Vdd2, Vdd1	Power supply voltage. Bypass capacitors are required. See application circuit.	
	GND	Package bottom must be connected to RF/DC ground	



**GAAS PHEMT MMIC LOW NOISE  
AMPLIFIER, 4.8 - 6.0 GHz**
**THEORY OF OPERATION**

The HMC717A is a gallium arsenide (GaAs), monolithic microwave integrated circuit (MMIC), pseudomorphic (pHEMT), low noise amplifier. The HMC717A amplifier uses two gain stages in series, the basic schematic for the amplifier is shown in Figure 3, which forms a low noise amplifier operating from 4.8 GHz to 6 GHz with excellent noise figure performance.

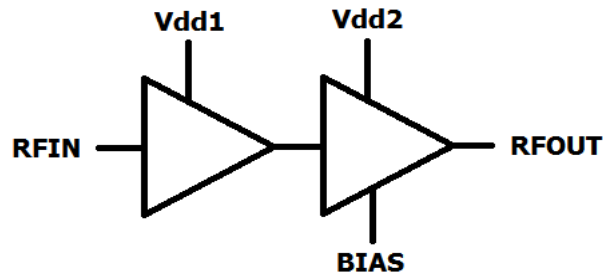

Basic Schematic for HMC717A

The HMC717A has single-ended input and output ports whose impedances are nominally equal to 50  $\Omega$  over the 4.8 GHz to 6 GHz frequency range. Consequently, it can directly insert into a 50  $\Omega$  system with no required impedance matching circuitry, which also means that multiple HMC717A amplifiers can be cascaded back to back without the need for external matching circuitry. The input and output impedances are sufficiently stable vs. variations in temperature and supply voltage that no impedance matching compensation is required. Note that it is critical to supply very low inductance ground connections to the backside exposed paddle to ensure stable operation. To achieve optimal performance from the HMC717A and prevent damage to the device, the absolute maximum ratings should not be exceeded.

**APPLICATIONS INFORMATION**

The figure above shows the basic connections for operating the HMC717A. AC couple the input with 1.2 pF capacitor. The RF output of the HMC717A has on chip DC block capacitor which eliminates the need for external AC coupling capacitor. Use the appropriate Rbias resistor values, given in the Absolute Bias Resistor Range & Recommended Bias Resistor Values table on page 6. The bias conditions previously listed (VDD = 5 V, Rbias = 825 $\Omega$  and VDD = 3 V, Rbias = 5.76k $\Omega$ ) are the recommended operating points to achieve optimum performance. The data used in this data sheet was taken with the recommended bias conditions. When using the HMC717A with different bias conditions, different performance than what is shown in the Typical Performance Characteristics section may result. Increasing the Vdd level and changing the Rbias resistor to the recommended value, typically improves gain, IP3 and noise figure at the expense of power consumption. This behavior can be seen on Typical Performance Characteristics plots.

**GAAS PHEMT MMIC LOW NOISE AMPLIFIER, 4.8 - 6.0 GHz**

**Application Circuit**

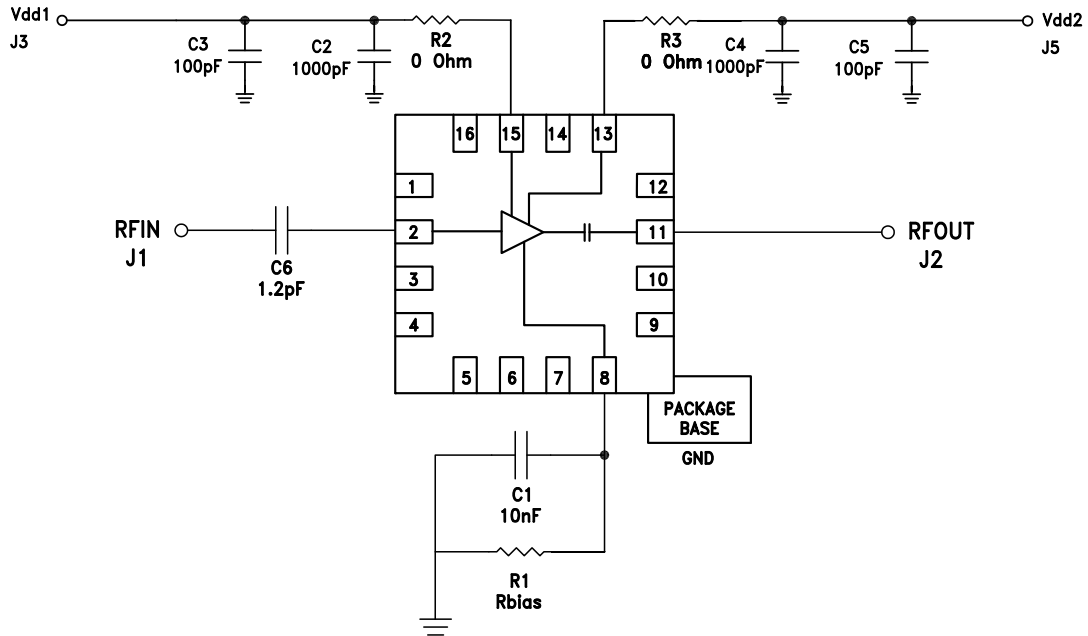

HMC717ALP3FE Evaluation Board Schematic

## GAAS PHEMT MMIC LOW NOISE AMPLIFIER, 4.8 - 6.0 GHz

### Evaluation PCB

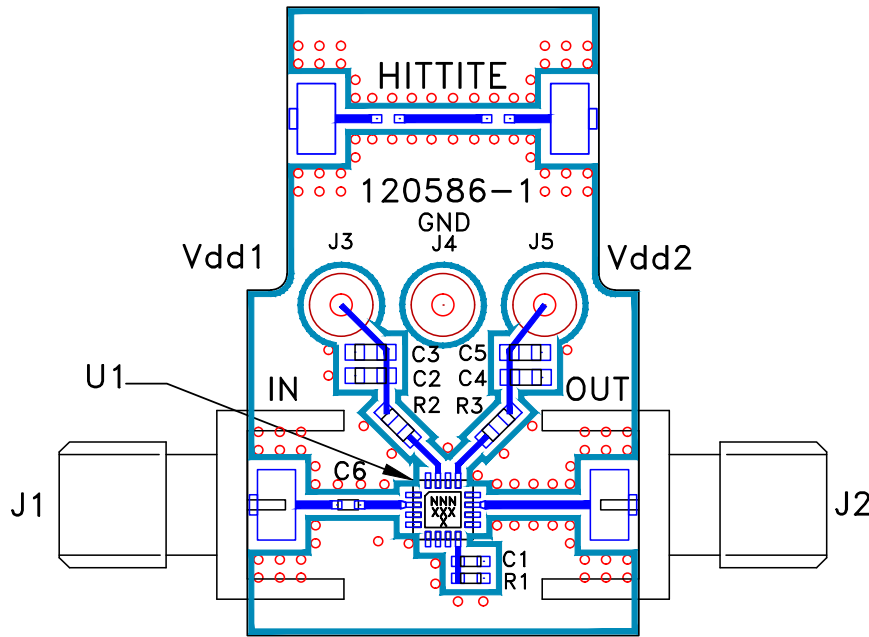

Evaluation Printed Circuit Board (PCB)

### List of Materials for Evaluation PCB EV1HMC717ALP3 [1]

Item	Description
J1, J2	PCB mount SMA RF connectors, Johnson 142-0701-851
J3 - J5	PCB mount SMA RF connectors, Johnson 142-0701-851
C1	Capacitor, ceramic, 10 nF, 16 V, X7R, 0402 package.
C2, C4	Capacitor, ceramic, 1 nF, 50 V, X7R, 0603 package.
C3, C5	Capacitor, ceramic, 0.1 $\mu$ F, 50 V, X7R, 0603 package.
C6	Capacitor, ceramic, 1.2 pF, 25 V, COG, High Q, 0402 package.
R1	Resistor, 825 Ohm 1%, 0402 Pkg. (Rbias)
R2, R3	0 Ohm Resistor, 0402 Pkg.
U1	HMC717ALP3E Amplifier
PCB	120586 evaluation PCB; circuit board material: Rogers 4350

[1] Reference this number when ordering complete evaluation PCB

The HMC717ALP3E evaluation board is a four-layer board fabricated using Rogers 4350 and using best practices for high frequency RF design. The RF input and RF output traces have a 50  $\Omega$  characteristic impedance.

The HMC717ALP3E evaluation board and populated components are designed to operate over the ambient temperature range of  $-40^{\circ}\text{C}$  to  $+85^{\circ}\text{C}$ . For proper bias sequence, please see the Applications information section of the datasheet.

The HMC717ALP3E evaluation board schematic (HMC717ALP3FE Evaluation Board Schematic) is shown on page 10. A fully populated and tested evaluation board, shown above, is available from Analog Devices, Inc., upon request.