



GAAS PHEMT MMIC 1.5 WATT POWER AMPLIFIER, 24 - 31.5 GHz

Typical Applications

The HMC943LP5E is ideal for:

- Point-to-Point Radios
- Point-to-Multi-Point Radios
- VSAT
- Military & Space

Features

- Saturated Output Power: +34 dBm @ 24% PAE
- High Output IP3: +41 dBm
- High Gain: 21 dB
- DC Supply: +5.5V @ 1200 mA
- No External Matching Required
- 32 Lead 5 x 5 mm SMT Package: 25 mm²

Functional Diagram

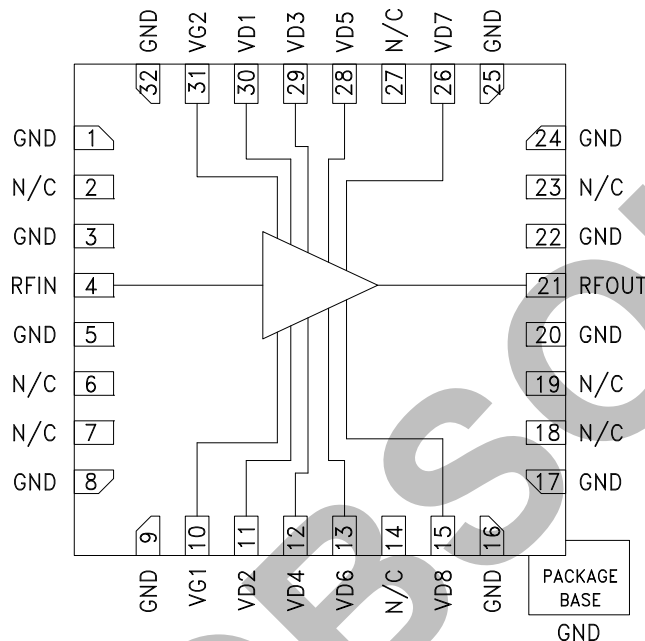

General Description

The HMC943LP5E is a four stage GaAs pHEMT MMIC 1.5 Watt Power Amplifier which operates between 24 and 31.5 GHz. The HMC943LP5E provides 21 dB of gain, and +34 dBm of saturated output power and 24% PAE from a +5.5V supply. The high output IP3 of +41 dBm makes the HMC943LP5E ideal for microwave radio applications. The HMC943LP5E amplifier I/Os are internally matched to 50 Ohms and is packaged in a leadless QFN 5 x 5 mm surface mount package and requires no external matching components.

Electrical Specifications, $T_A = +25^\circ\text{C}$, $V_{d1} = V_{d8} = +5.5\text{V}$, $I_{dd} = 1200\text{ mA}$ [1]

Parameter	Min.	Typ.	Max.	Min.	Typ.	Max.	Units
Frequency Range	24 - 26.5		26.5 - 31.5				GHz
Gain	18	21		16	19		dB
Gain Variation Over Temperature		0.03			0.028		dB/°C
Input Return Loss		9			9.5		dB
Output Return Loss		12			12		dB
Output Power for 1 dB Compression (P1dB)	29	32		27	31		dBm
Saturated Output Power (P _{sat})		33			33		dBm
Output Third Order Intercept (IP3) ^[2]		41			39		dBm
Total Supply Current (I _{dd})		1200			1200		mA

[1] Adjust Vg1 and Vg2 between -2 to 0V to achieve I_{dd} = 1200 mA typical.

[2] Measurement taken at +5.5V @ 1200 mA, P_{out} / Tone = +22 dBm



GAAS PHEMT MMIC 1.5 WATT POWER AMPLIFIER, 24 - 31.5 GHz

Broadband Gain & Return Loss vs. Frequency

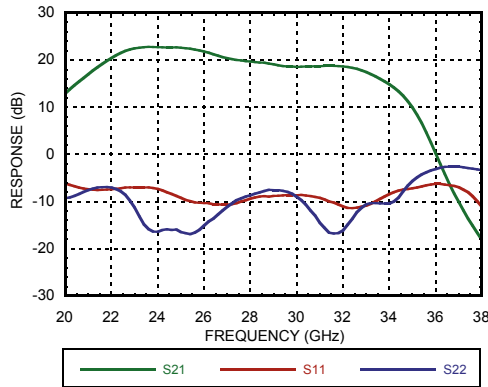

Gain vs. Temperature

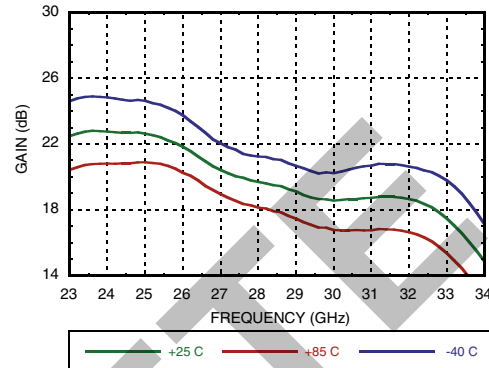

Input Return Loss vs. Temperature

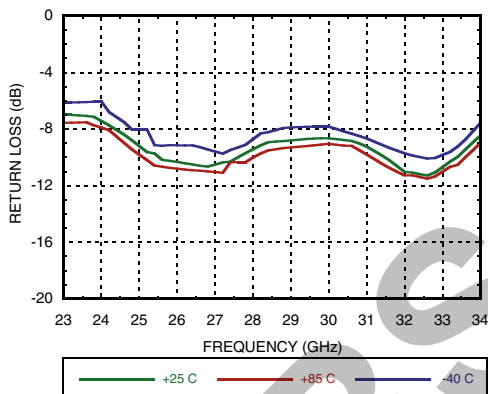

Output Return Loss vs. Temperature

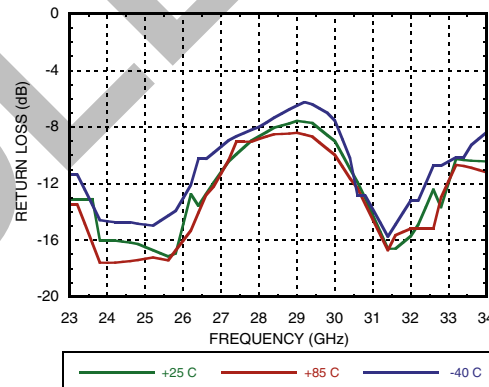

P1dB vs. Temperature

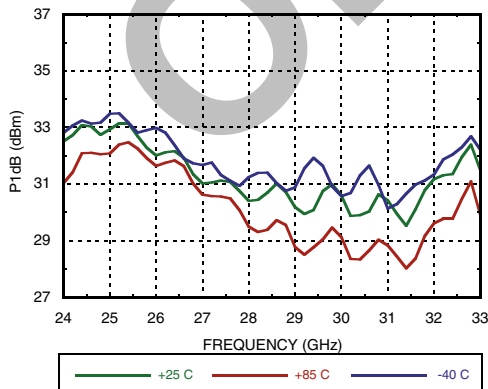

P1dB vs. Supply Voltage

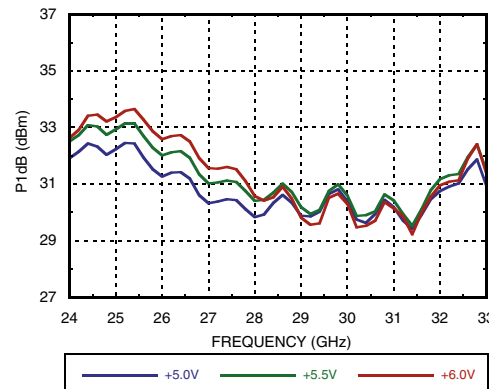

Information furnished by Analog Devices is believed to be accurate and reliable. However, no responsibility is assumed by Analog Devices for its use, nor for any infringements of patents or other rights of third parties that may result from its use. Specifications subject to change without notice. No license is granted by implication or otherwise under any patent or patent rights of Analog Devices. Trademarks and registered trademarks are the property of their respective owners.

For price, delivery, and to place orders: Analog Devices, Inc., One Technology Way, P.O. Box 9106, Norwood, MA 02062-9106 Phone: 781-329-4700 • Order online at www.analog.com Application Support: Phone: 1-800-ANALOG-D



**GAAS PHEMT MMIC 1.5 WATT
POWER AMPLIFIER, 24 - 31.5 GHz**

AMPLIFIERS - LINEAR & POWER - SMT

Psat vs. Temperature

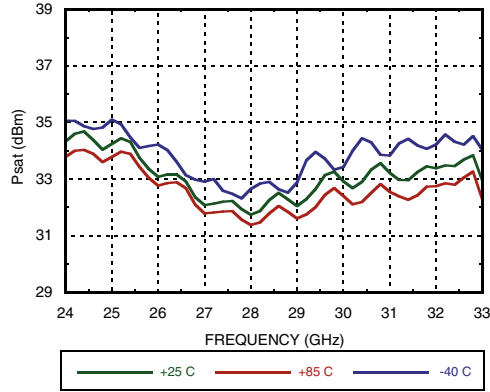

Psat vs. Supply Voltage

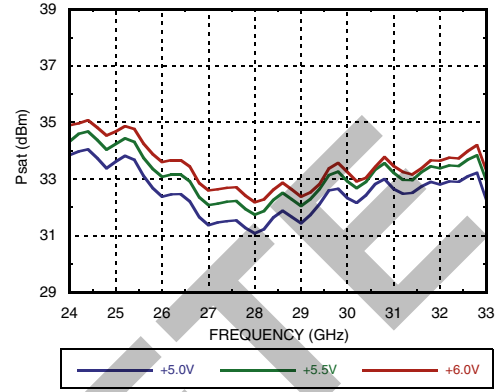

P1dB vs. Supply Current (Idd)

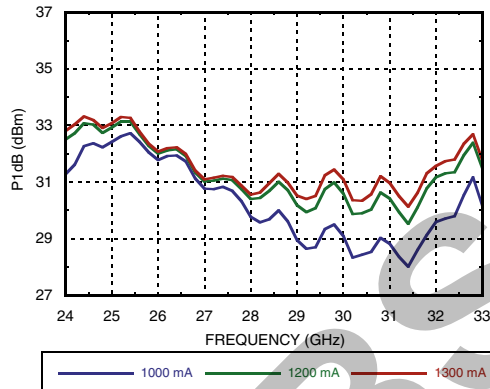

Psat vs. Supply Current (Idd)

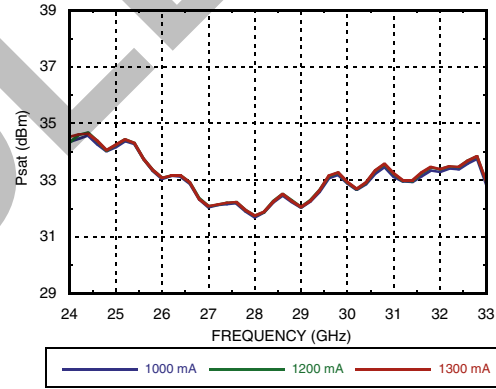

Output IP3 vs. Temperature, Pout/Tone = +22 dBm

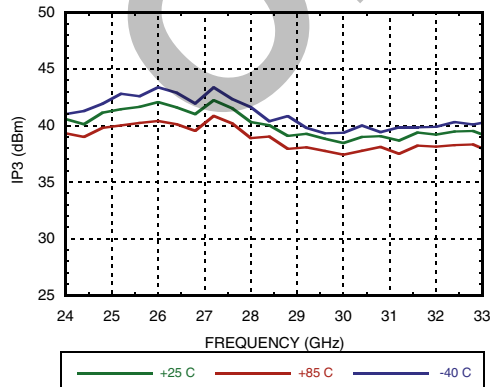

Output IP3 vs. Supply Current, Pout/Tone = +22 dBm

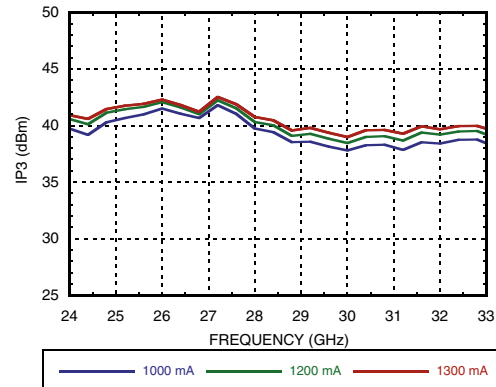

Information furnished by Analog Devices is believed to be accurate and reliable. However, no responsibility is assumed by Analog Devices for its use, nor for any infringements of patents or other rights of third parties that may result from its use. Specifications subject to change without notice. No license is granted by implication or otherwise under any patent or patent rights of Analog Devices. Trademarks and registered trademarks are the property of their respective owners.

For price, delivery, and to place orders: Analog Devices, Inc., One Technology Way, P.O. Box 9106, Norwood, MA 02062-9106 Phone: 781-329-4700 • Order online at www.analog.com Application Support: Phone: 1-800-ANALOG-D



GAAS PHEMT MMIC 1.5 WATT POWER AMPLIFIER, 24 - 31.5 GHz

Output IP3 vs. Supply Voltage, Pout/Tone = +22 dBm

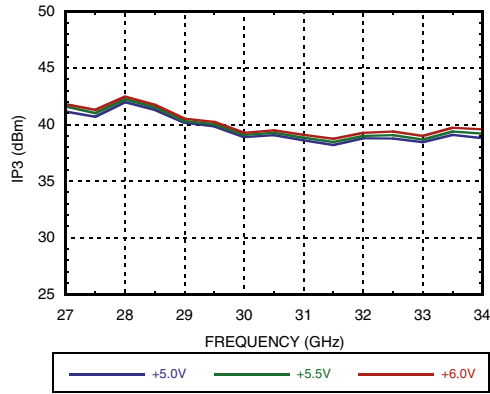

Output IM3 @ Vdd = +5V

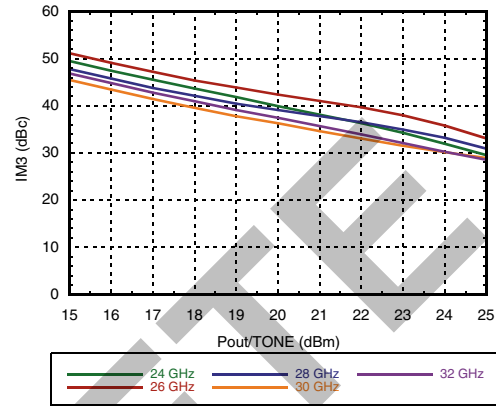

Output IM3 @ Vdd = +5.5V

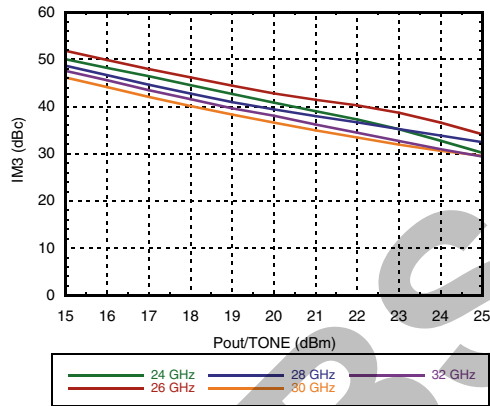

Output IM3 @ Vdd = +6V

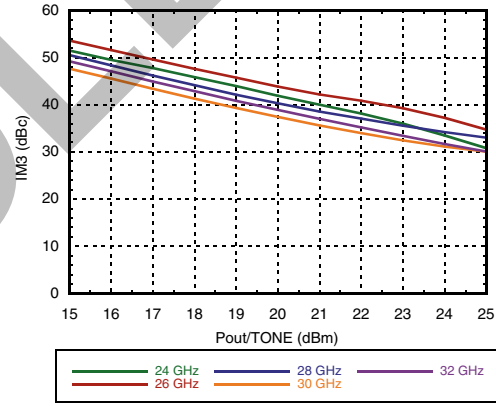

Power Compression @ 24 GHz

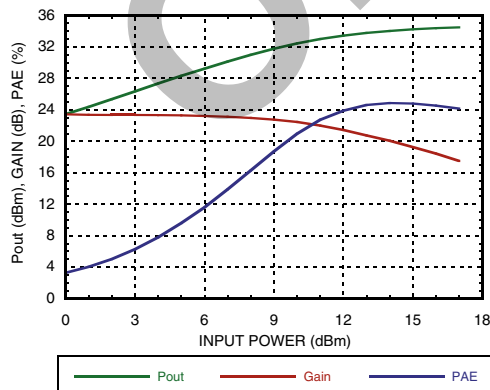

Power Compression @ 29 GHz

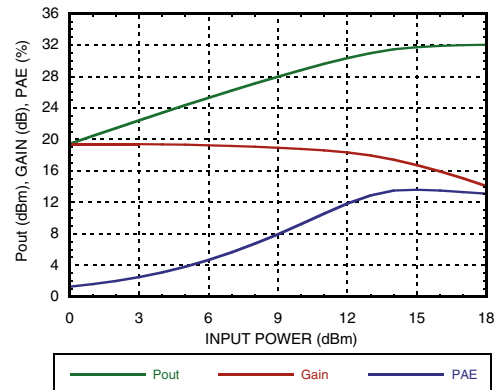

Information furnished by Analog Devices is believed to be accurate and reliable. However, no responsibility is assumed by Analog Devices for its use, nor for any infringements of patents or other rights of third parties that may result from its use. Specifications subject to change without notice. No license is granted by implication or otherwise under any patent or patent rights of Analog Devices. Trademarks and registered trademarks are the property of their respective owners.

For price, delivery, and to place orders: Analog Devices, Inc., One Technology Way, P.O. Box 9106, Norwood, MA 02062-9106 Phone: 781-329-4700 • Order online at www.analog.com Application Support: Phone: 1-800-ANALOG-D



GAAS PHEMT MMIC 1.5 WATT POWER AMPLIFIER, 24 - 31.5 GHz

Power Compression @ 32 GHz

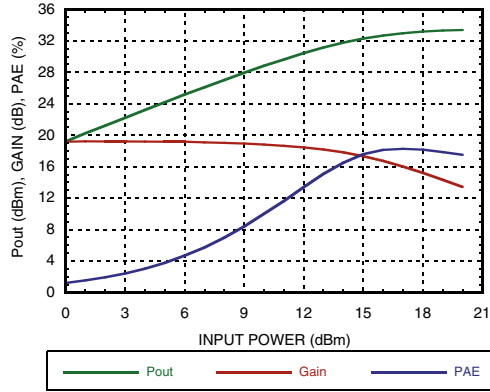

Reverse Isolation

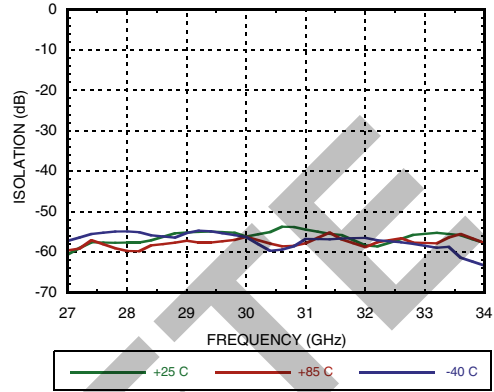

Gain & Power vs. Supply Current @ 26 GHz

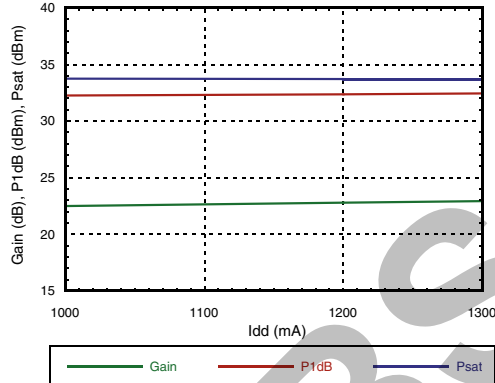

Gain & Power vs. Supply Voltage @ 26 GHz

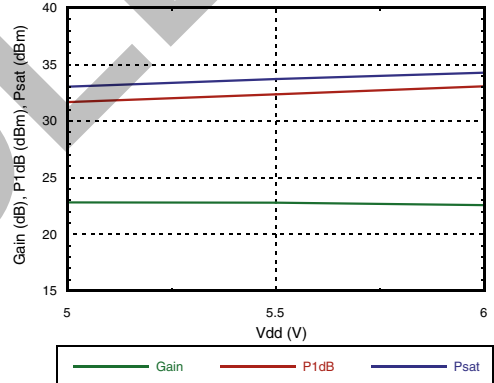

Power Dissipation @ 6V, 1200 mA

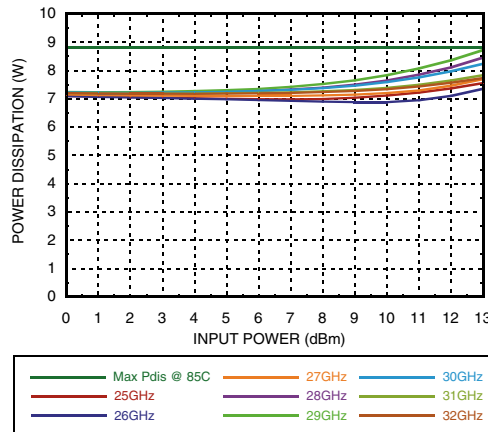

Information furnished by Analog Devices is believed to be accurate and reliable. However, no responsibility is assumed by Analog Devices for its use, nor for any infringements of patents or other rights of third parties that may result from its use. Specifications subject to change without notice. No license is granted by implication or otherwise under any patent or patent rights of Analog Devices. Trademarks and registered trademarks are the property of their respective owners.

For price, delivery, and to place orders: Analog Devices, Inc., One Technology Way, P.O. Box 9106, Norwood, MA 02062-9106 Phone: 781-329-4700 • Order online at www.analog.com Application Support: Phone: 1-800-ANALOG-D



GAAS PHEMT MMIC 1.5 WATT POWER AMPLIFIER, 24 - 31.5 GHz

Absolute Maximum Ratings

Drain Bias Voltage (Vd)	+7V
RF Input Power (RFIN)	+20 dBm
Channel Temperature	150 °C
Continuous P _{diss} (T= 85 °C) (derate 135 mW/°C above 85 °C)	8.8 W
Thermal Resistance (channel to package bottom)	7.4 °C/W
Storage Temperature	-65 to +150 °C
Operating Temperature	-55 to +85 °C
ESD Sensitivity (HBM)	Class 0, 150V

Typical Supply Current vs. V_{dd}

V _{dd} (V)	I _{dd} (mA)
+5.0	1200
+5.5	1200
+6.0	1200

Note: Amplifier will operate over full voltage ranges shown above V_{gg} adjusted to achieve I_{dd} = 1200 mA



**ELECTROSTATIC SENSITIVE DEVICE
OBSERVE HANDLING PRECAUTIONS**

Outline Drawing

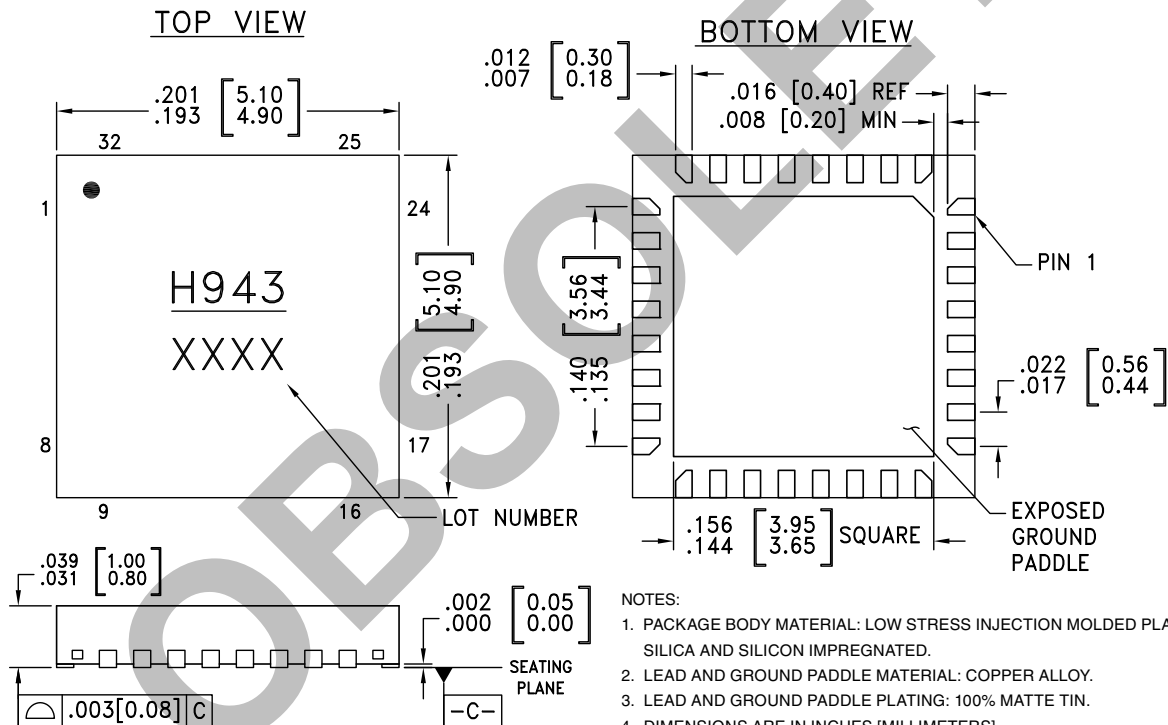

NOTES:

- PACKAGE BODY MATERIAL: LOW STRESS INJECTION MOLDED PLASTIC SILICA AND SILICON IMPREGNATED.
- LEAD AND GROUND PADDLE MATERIAL: COPPER ALLOY.
- LEAD AND GROUND PADDLE PLATING: 100% MATTE TIN.
- DIMENSIONS ARE IN INCHES [MILLIMETERS].
- LEAD SPACING TOLERANCE IS NON-CUMULATIVE.
- PAD BURR LENGTH SHALL BE 0.15mm MAX. PAD BURR HEIGHT SHALL BE 0.25mm MAX.
- PACKAGE WARP SHALL NOT EXCEED 0.05mm.
- ALL GROUND LEADS AND GROUND PADDLE MUST BE SOLDERED TO PCB RF GROUND.

Package Information

Part Number	Package Body Material	Lead Finish	MSL Rating	Package Marking ^[1]
HMC943LP5E	RoHS-compliant Low Stress Injection Molded Plastic	100% matte Sn	MSL1 ^[2]	H943 XXXX

[1] 4-Digit lot number XXXX

[2] Max peak reflow temperature of 260 °C



GAAS PHEMT MMIC 1.5 WATT POWER AMPLIFIER, 24 - 31.5 GHz

Pin Descriptions

Pin Number	Function	Description	Interface Schematic
1, 3, 5, 8, 9, 16, 17, 20, 22, 24, 25, 32	GND	These pins and package bottom must be connected to RF/DC ground.	
2, 6, 7, 14, 18, 19, 23, 27	N/C	These pins are not connected internally; however, all data shown herein was measured with these pins connected to RF/DC ground externally.	
4	RFIN	RF signal input. This pad is AC coupled and matched to 50 Ohms over the operating frequency range.	
10, 31	VG1, VG2	Gate control for amplifier. External bypass capacitors of 100 pF, 0.01 μF, and 4.7 μF are required on each.	
11 - 13, 15, 26, 28 - 30	VD2, VD4, VD6, VD8, VD7, VD5, VD3, VD1	Drain bias for the amplifier. External bypass capacitors of 100 pF, 0.01 μF, and 4.7 μF are required on each.	
21	RFOUT	RF signal output. This pad is AC coupled and matched to 50 ohms over the operating frequency range.	

Application Circuit

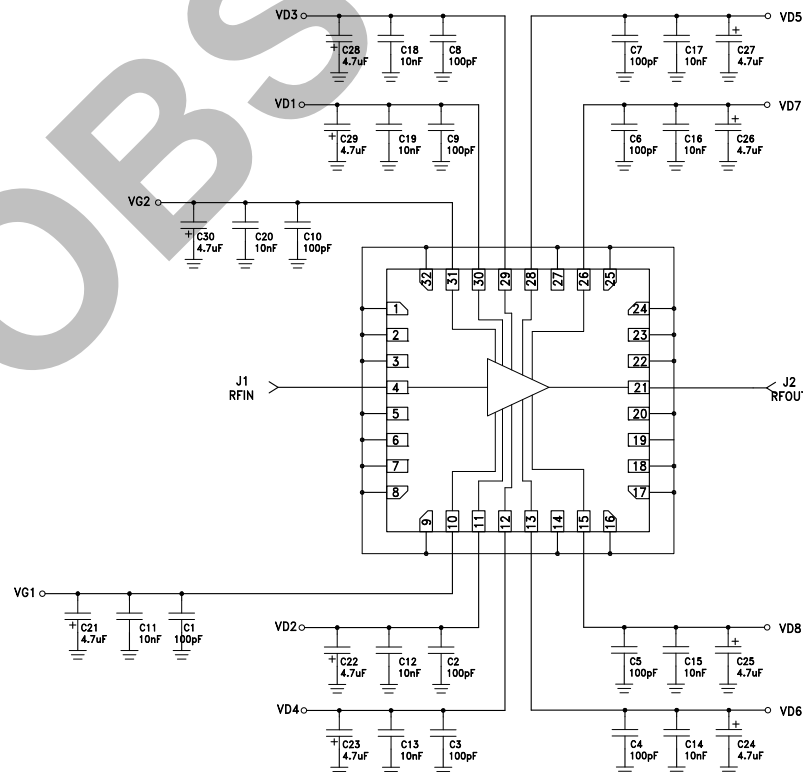

Information furnished by Analog Devices is believed to be accurate and reliable. However, no responsibility is assumed by Analog Devices for its use, nor for any infringements of patents or other rights of third parties that may result from its use. Specifications subject to change without notice. No license is granted by implication or otherwise under any patent or patent rights of Analog Devices. Trademarks and registered trademarks are the property of their respective owners.

For price, delivery, and to place orders: Analog Devices, Inc., One Technology Way, P.O. Box 9106, Norwood, MA 02062-9106 Phone: 781-329-4700 • Order online at www.analog.com Application Support: Phone: 1-800-ANALOG-D



**GAAS PHEMT MMIC 1.5 WATT
POWER AMPLIFIER, 24 - 31.5 GHz**

Evaluation PCB

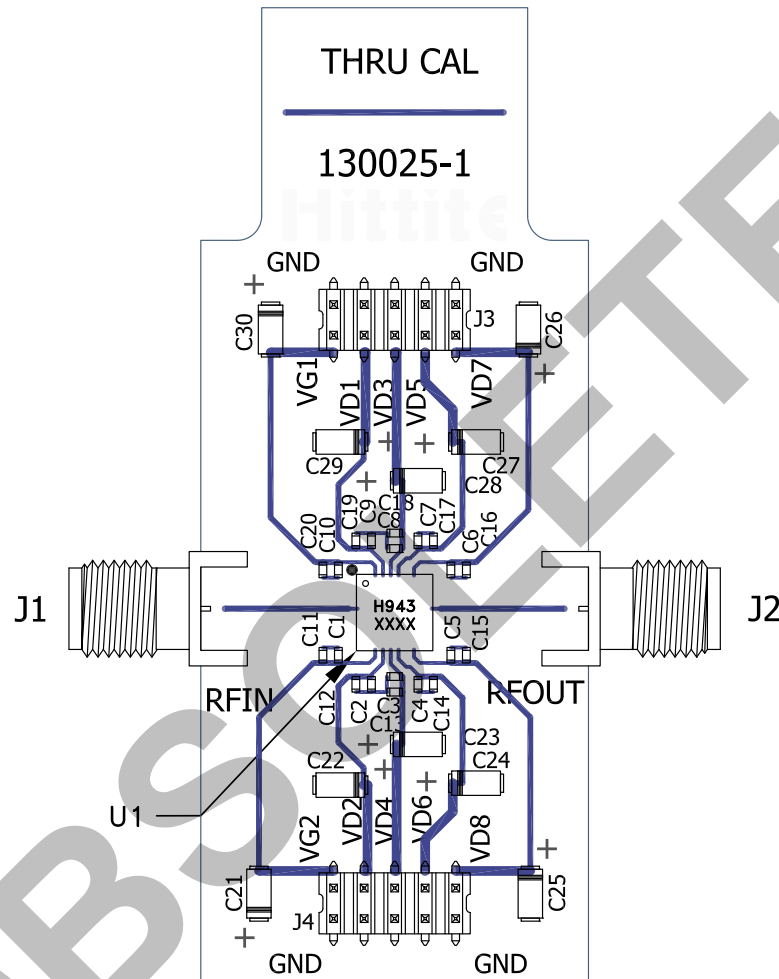

List of Materials for Evaluation PCB 130027 [1]

Item	Description
J1, J2	SRI, K Connectors
J3, J4	DC Pins
C1 - C10	100 pF Capacitors, 0402 Pkg.
C11 - C20	10000 pF Capacitors, 0402 Pkg.
C21 - C30	4.7 μF Capacitors, Case A Pkg.
U1	HMC943LP5E Power Amplifier
PCB [2]	130025 Evaluation PCB

[1] Reference this number when ordering complete evaluation PCB

[2] Circuit Board Material: Rogers 4350 or Arlon FR4

The circuit board used in the application should use RF circuit design techniques. Signal lines should have 50 Ohm impedance while the package ground leads and exposed paddle should be connected directly to the ground plane similar to that shown. A sufficient number of via holes should be used to connect the top and bottom ground planes. The evaluation board should be mounted to an appropriate heat sink. The evaluation circuit board shown is available from Hittite upon request.