

HOA0708/0709

Reflective Sensor

FEATURES

- Choice of phototransistor or photodarlington output
- Focused for maximum response
- Ambient light and dust protective filter
- Adjustable mounting slot

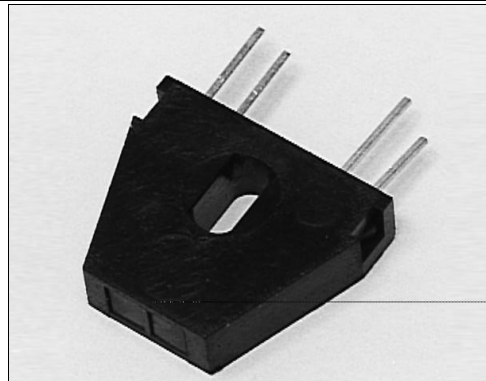

INFRA-56.TIF

DESCRIPTION

The HOA0708/0709 series consists of an infrared emitting diode and an NPN silicon phototransistor (HOA0708-001, -011) or photodarlington (HOA0709-001, -011) encased side-by-side on converging optical axes in a black thermoplastic housing. The detector responds to radiation from the IRED only when a reflective object passes within its field of view. The HOA0708-011 and HOA0709-011 employ an IR transmissive filter to minimize the effects of visible ambient light and provide a smooth optical face which prevents the accumulation of airborne contaminants in the optical path. The HOA0708/0709 series employs plastic molded components. For additional component information see SEP8505, SDP8405, and SDP8105.

Housing material is polycarbonate. Housings are soluble in chlorinated hydrocarbons and ketones. Recommended cleaning agents are methanol and isopropanol.

OUTLINE DIMENSIONS in inches (mm)

Tolerance 3 plc decimals $\pm 0.010(0.25)$
2 plc decimals $\pm 0.020(0.51)$

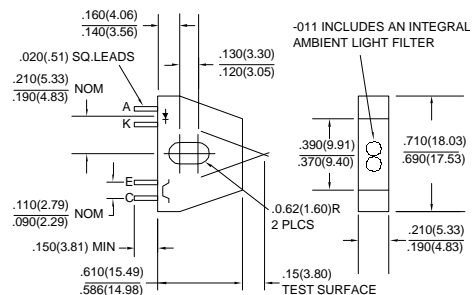

DIM_033.dwg

HOA0708/0709

Reflective Sensor

ELECTRICAL CHARACTERISTICS (25°C unless otherwise noted)

PARAMETER	SYMBOL	MIN	TYP	MAX	UNITS	TEST CONDITIONS
IR EMITTER						
Forward Voltage	V_F			1.6	V	$I_F=20\text{ mA}$
Reverse Leakage Current	I_R			10	μA	$V_R=3\text{ V}$
DETECTOR						
Collector-Emitter Breakdown Voltage HOA0708-001, -011 HOA0709-001, -011	$V_{(BR)CEO}$	30 15			V	$I_C=100\ \mu\text{A}$
Emitter-Collector Breakdown Voltage	$V_{(BR)ECO}$	5.0			V	$I_E=100\ \mu\text{A}$
Collector Dark Current HOA0708-001, -011 HOA0709-001, -011	I_{CEO}			100 250	nA	$V_{CE}=10\text{ V}$ $I_F=0$
COUPLED CHARACTERISTICS						
On-State Collector Current HOA0708-001, -011 HOA0709-001, -011	$I_{C(ON)}$	0.2 1.0				$V_{CE}=5\text{ V}$ $I_F=40\text{ mA}$ (1)
Collector-Emitter Saturation Voltage HOA0708-001, -011 HOA0709-001, -011	$V_{CE(SAT)}$			0.4 1.1	V	$I_F=40\text{ mA}$ (1) $I_C=30\ \mu\text{A}$ $I_C=125\ \mu\text{A}$
Rise And Fall Time HOA0708-001, -011 HOA0709-001, -011	t_r, t_f		15 75		μs	$V_{CC}=5\text{ V}, I_C=1\text{ mA}$ $R_L=1000\ \Omega$ $R_L=100\ \Omega$

Notes

1. Test surface is Eastman Kodak neutral white test card with 90% diffuse reflectance located 0.15 in. (3.80 mm) from the front surface of the device.

ABSOLUTE MAXIMUM RATINGS

Operating Temperature Range -40°C to 85°C
Storage Temperature Range -40°C to 85°C
Soldering Temperature (5 sec) 240°C

IR EMITTER

Power Dissipation 70 mW (1)
Reverse Voltage 3 V
Continuous Forward Current 50 mA

DETECTOR

	TRANS.	DARLINGTON
Collector-Emitter Voltage	30 V	15 V
Emitter-Collector Voltage	5 V	5 V
Power Dissipation	70 mW (1)	70 mW (1)
Collector DC Current	30 mA	30 mA

SCHEMATIC

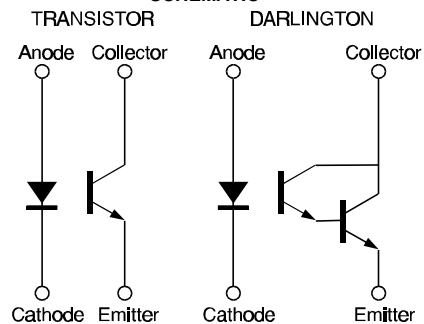

Honeywell reserves the right to make changes in order to improve design and supply the best products possible.

Honeywell

HOA0708/0709

Reflective Sensor

Fig. 1 IRED Forward Bias Characteristics

gra_073.ds4

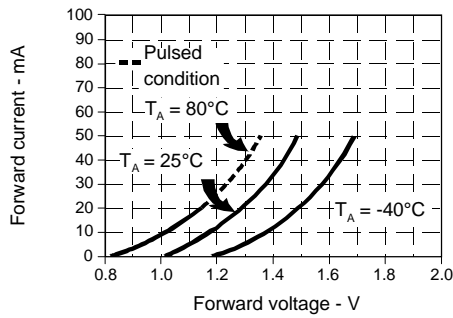

Fig. 2 Non-Saturated Switching Time vs Load Resistance

gra_079.ds4

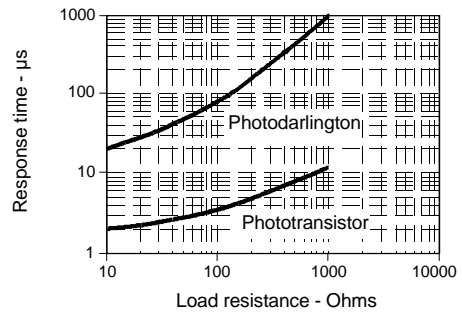

Fig. 3 Dark Current vs Temperature

gra_301.cdr

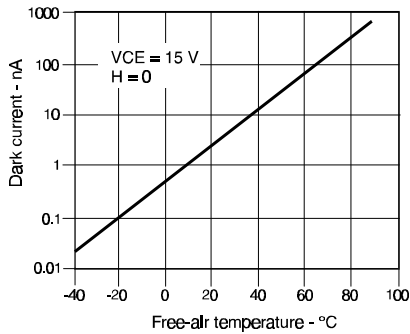

Fig. 4 Collector Current vs Ambient Temperature

gra_076.ds4

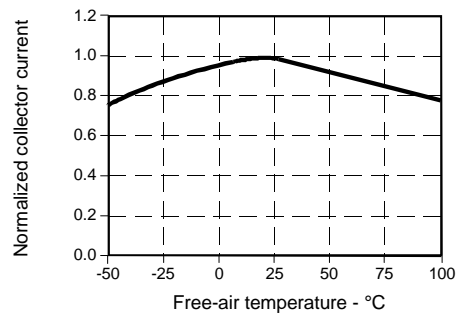

Fig. 5 Collector Current vs Distance to Reflective Surface

gra_080.ds4

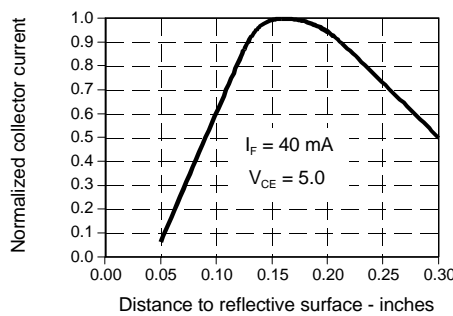
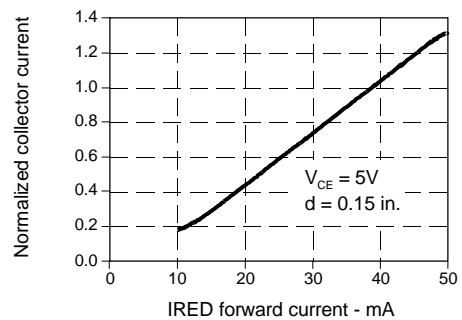

Fig. 6 Collector Current vs IRED Forward Current

gra_081.ds4



All Performance Curves Show Typical Values

HOA0708/0709
Reflective Sensor



Honeywell reserves the right to make changes in order to improve design and supply the best products possible.

Honeywell