

HP - 2ML

The HP - 2ML, a high - output, high - speed silicon photodiode mounted in TO - 18 type header with clear epoxy encapsulation, permits wide angular response.

FEATURES

- High - output power
- High - speed response
- Wide angular response
- Relatively low - cost against metal can package

APPLICATIONS

- Optical detectors
- Optical switches

DIMENSIONS

(Unit : mm)

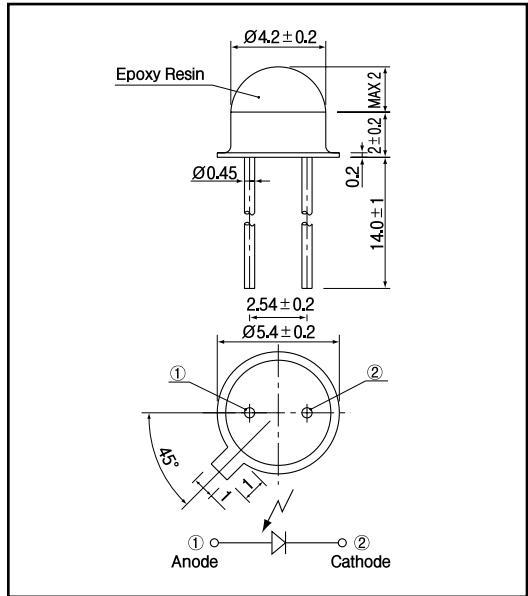

MAXIMUM RATINGS

(Ta=25)

Item	Symbol	Rating	Unit
Reverse voltage	V_R	5	V
Operating temp.	Topr.	- 20 ~ +80	
Storage temp.	Tstg.	- 20 ~ +80	
Soldering temp. *1	Tsol.	260	

*1. For MAX.5 seconds at the position of 2 mm from the package

ELECTRO-OPTICAL CHARACTERISTICS

(Ta=25)

Item	Symbol	Conditions	Min.	Typ.	Max.	Unit.
Open circuit voltage	V_{oc}	$E_v = 1,000lx^{-2}$		0.38		V
Short circuit current	I_{sc}			28		μA
Dark current	I_d	$V_R = 5V$			1	μA
Curve factor	C.F.		0.55			-
Capacitance	C_t	$V = 0V, f = 1MHz$		60		pF
Temperature coefficient of V_{oc}	t			- 2.2		mV/
Temperature coefficient of I_{sc}	t			0.18		%/
Spectral sensitivity				450 ~ 1,050		nm
Peak wavelength	ρ			900		nm
Half angle				± 60		deg.

*2. Color temp. = 2856K standard Tungsten lamp

Photo diodes

HP - 2ML

Light current Vs. Forward voltage

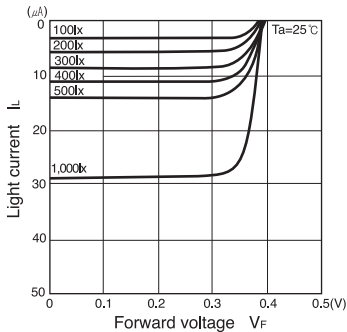

Short circuit current Vs. Illuminance

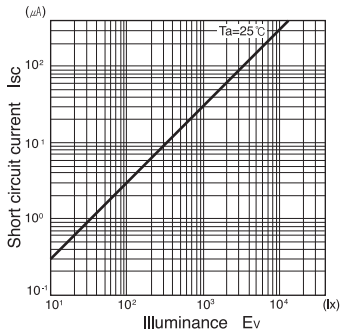

Dark current Vs. Ambient temperature

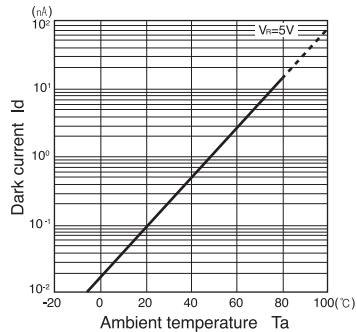

Relative sensitivity Vs. Wavelength

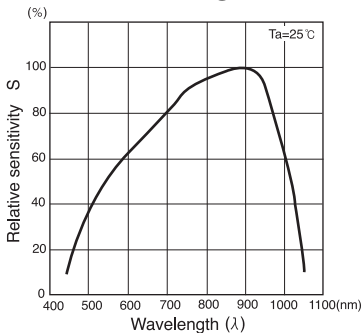

Dark current Vs. Reverse voltage

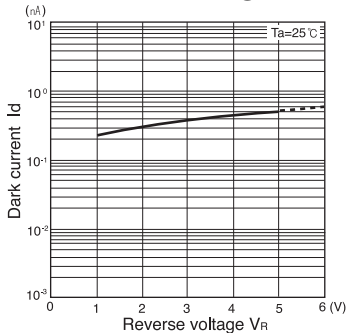

Radiant Pattern

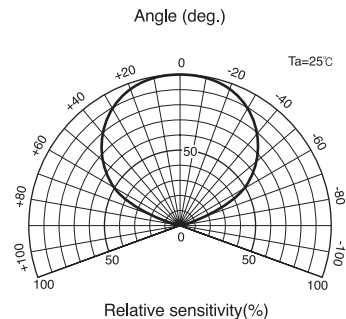

Capacitance between terminals Vs. Reverse voltage

