

10 AMP POWER RELAY

HP RELAYS



RoHS Directive compatibility information
<http://www.mew.co.jp/ac/e/environment/>

FEATURES

1. High-capacity and long life

Mechanical life is more than 10 million operations and, with electrical life of more than 200,000 operations (resistive load 10 A; inductive load 7.5 A), the relay has excellent inductive load durability.

2. Easy mounting and wiring

The terminal arrangement is apparent at a glance and wiring is easy. Moreover, quick tab terminal is also possible.

3. Operation indicator option

Optional operation indicators are available for easy visual confirmation that relays are operating. They simplify maintenance.

4. UL/CSA approved

5. Wide range of sockets and terminal sockets

To enable use with DIN rails, DIN terminal sockets are also available.

TYPICAL APPLICATIONS

HP relays enjoy wide use in various applications, particularly in automation controls and remote controls.

Applications include:

1. Industrial machinery

For controlling positioning, pressure, and temperature in molding equipment, boilers, pumps, charging pressure equipment, measuring and evaluation equipment, textile machines, etc.

2. Machine tools

Control of positioning and directional change in turning machines, lathes, borers, etc.

3. Food processing packing machines

Automatic control of packing equipment for milk and seafood, bottling, canning, and packaging

4. Office equipment

Control of copiers, time recorders, etc.

5. Coin operate machines

Control of food, cigarette, and other vending machines

6. Transportation

Amplification of control signals in control devices for vehicles and vessels, functional parts of all kinds of equipment, control signal repeating installation in signaling devices and equipment.

7. Measuring devices and equipment

For repeating installation of control signals and in power amplifiers

8. Generators, transformers and power receiving equipment.

Functional parts in protective equipment, functional assistance in automatic adjustment equipment, telemeters and other remote monitoring equipment

9. Control of conveyance equipment

Control panels for elevators, escalators, and other conveyance equipment, control of all kinds industrial transport equipment such as conveyors.

10. Amusement equipment

Control of equipment in amusement parks, etc., control of bowling alley equipment, control of fountains in public parks

About Cd-free contacts

We have introduced Cadmium free type products to reduce Environmental Hazardous Substances. (The suffix "F" should be added to the part number. The Suffix "F" is required only for 4 Form C contact type. The 2 Form C and 3 Form C contact type is originally cadmium-free, the suffix "F" is not required.)

Please replace parts containing Cadmium with Cadmium-free products and evaluate them with your actual application before use because the life of a relay depends on the contact material and load.

ORDERING INFORMATION



Contact arrangement

- 2: 2 Form C
- 3: 3 Form C
- 4: 4 Form C

Terminal arrangement

- Nil: Standard plug-in terminal
- TM: TM type (2 Form C only)
- M: Direct mounting (3 Form C only)

Operation indication

- Nil: Without indication
- L: With indication

Coil voltage

- AC 6, 12, 24, 48, 100, (115), 200, (220), (240) V
- DC 6, 12, 24, 48, 100, (110) V

Contact material

- F: 4 Form C, Silver alloy (cadmium-free)
- Nil: 2 Form C, 3 Form C (Silver)

With LED indicator type









Coil voltage: 6, 12, 24 V AC 6, 12, 24, 48 V DC

With neon lamp type

Coil voltage: 100, 115, 200, 220, 240 V AC 100, 110 V DC

TYPES









1. Plug-in type

| Coil voltage | 2 Form C | | 3 Form C | | 4 Form C | |
|--------------|---|------------|---|------------|---|--------------|
| | | Part No. | | Part No. | | Part No. |
| 6V AC |  | HP2-AC6V |  | HP3-AC6V |  | HP4-AC6V-F |
| 12V AC |  | HP2-AC12V |  | HP3-AC12V |  | HP4-AC12V-F |
| 24V AC | | HP2-AC24V | | HP3-AC24V | | HP4-AC24V-F |
| 48V AC | | HP2-AC48V | | HP3-AC48V | | HP4-AC48V-F |
| 100V AC | | HP2-AC100V | | HP3-AC100V | | HP4-AC100V-F |
| 115V AC | | HP2-AC115V | | HP3-AC115V | | HP4-AC115V-F |
| 200V AC | | HP2-AC200V | | HP3-AC200V | | HP4-AC200V-F |
| 220V AC | | HP2-AC220V | | HP3-AC220V | | HP4-AC220V-F |
| 240V AC | | HP2-AC240V | | HP3-AC240V | | HP4-AC240V-F |
| 6V DC |  | HP2-DC6V |  | HP3-DC6V |  | HP4-DC6V-F |
| 12V DC | | HP2-DC12V | | HP3-DC12V | | HP4-DC12V-F |
| 24V DC | | HP2-DC24V | | HP3-DC24V | | HP4-DC24V-F |
| 48V DC | | HP2-DC48V | | HP3-DC48V | | HP4-DC48V-F |
| 100V DC | | HP2-DC100V | | HP3-DC100V | | HP4-DC100V-F |
| 110V DC | | HP2-DC110V | | HP3-DC110V | | HP4-DC110V-F |

Standard packing (2 Form C): Carton: 20 pcs.; Case: 100 pcs.

Standard packing (3 Form C, 4 Form C): Carton: 10 pcs.; Case: 50 pcs.







2. Plug-in type (with LED indication)

| | Coil voltage | 2 Form C | | 3 Form C | | 4 Form C | |
|---------------------|--------------|---|--------------|---|--------------|---|----------------|
| | | Part No. | | Part No. | | Part No. | |
| With LED indication | 6V AC |  | HP2-L-AC6V |  | HP3-L-AC6V |  | HP4-L-AC6V-F |
| | 12V AC |  | HP2-L-AC12V |  | HP3-L-AC12V |  | HP4-L-AC12V-F |
| | 24V AC | | HP2-L-AC24V | | HP3-L-AC24V | | HP4-L-AC24V-F |
| With neon lamp | 100V AC | | HP2-L-AC100V | | HP3-L-AC100V | | HP4-L-AC100V-F |
| | 115V AC | | HP2-L-AC115V | | HP3-L-AC115V | | HP4-L-AC115V-F |
| | 200V AC | | HP2-L-AC200V | | HP3-L-AC200V | | HP4-L-AC200V-F |
| | 220V AC | | HP2-L-AC220V | | HP3-L-AC220V | | HP4-L-AC220V-F |
| | 240V AC | | HP2-L-AC240V | | HP3-L-AC240V | | HP4-L-AC240V-F |
| With LED indication | 6V DC |  | HP2-L-DC6V |  | HP3-L-DC6V |  | HP4-L-DC6V-F |
| | 12V DC | | HP2-L-DC12V | | HP3-L-DC12V | | HP4-L-DC12V-F |
| | 24V DC | | HP2-L-DC24V | | HP3-L-DC24V | | HP4-L-DC24V-F |
| | 48V DC | | HP2-L-DC48V | | HP3-L-DC48V | | HP4-L-DC48V-F |
| With neon lamp | 100V DC | | HP2-L-DC100V | | HP3-L-DC100V | | HP4-L-DC100V-F |
| | 110V DC | | HP2-L-DC110V | | HP3-L-DC110V | | HP4-L-DC110V-F |

Standard packing (2 Form C): Carton: 20 pcs.; Case: 100 pcs.

Standard packing (3 Form C, 4 Form C): Carton: 10 pcs.; Case: 50 pcs.

3. TM type and Direct mount type

| Coil voltage | 2 Form C (TM type) | | 3 Form C (direct mount type) | |
|--------------|---|---------------|---|--------------|
| | Part No. | | Part No. | |
| 6V AC |  | HP2-TM-AC6V |  | HP3-M-AC6V |
| 12V AC |  | HP2-TM-AC12V |  | HP3-M-AC12V |
| 24V AC | | HP2-TM-AC24V | | HP3-M-AC24V |
| 48V AC | | HP2-TM-AC48V | | HP3-M-AC48V |
| 100V AC | | HP2-TM-AC100V | | HP3-M-AC100V |
| 115V AC | | HP2-TM-AC115V | | HP3-M-AC115V |
| 200V AC | | HP2-TM-AC200V | | HP3-M-AC200V |
| 220V AC | | HP2-TM-AC220V | | HP3-M-AC220V |
| 240V AC | | HP2-TM-AC240V | | HP3-M-AC240V |
| 6V DC |  | HP2-TM-DC6V |  | HP3-M-DC6V |
| 12V DC | | HP2-TM-DC12V | | HP3-M-DC12V |
| 24V DC | | HP2-TM-DC24V | | HP3-M-DC24V |
| 48V DC | | HP2-TM-DC48V | | HP3-M-DC48V |
| 100V DC | | HP2-TM-DC100V | | HP3-M-DC100V |
| 110V DC | | HP2-TM-DC110V | | HP3-M-DC110V |

Standard packing: Carton: 10 pcs.; Case: 50 pcs.

4. Direct mount type (with LED indication)

| | Coil voltage | 3 Form C | |
|----------------|--------------|----------|---------------|
| | | Part No. | |
| With neon lamp | 100V AC | | HP3-ML-AC100V |
| | 115V AC | | HP3-ML-AC115V |
| | 200V AC | | HP3-ML-AC200V |
| | 220V AC | | HP3-ML-AC220V |
| | 240V AC | | HP3-ML-AC240V |
| | 100V DC | | HP3-ML-DC100V |
| | 110V DC | | HP3-ML-DC110V |

Standard packing: Carton: 10 pcs.; Case: 50 pcs.

Notes: 1. Standard packaging is handled in units of inner cartons. Please specify if you require inner cartons to be boxed.







2. Sockets, terminal sockets and installation brackets are not included. Please order these separately.

3. For products compliant with international standards, please refer to the standards chart.



RATING DataSheet4U.com

1. Coil data

1) AC coils

| Contact arrangement | Nominal coil voltage | Nominal coil current (mA) | | Nominal operating power (VA) | | Inductance (H) | | Pick-up voltage (at 20°C 68°F) | Drop-out voltage (at 20°C 68°F) | Max. allowable voltage (at 20°C 68°F) |
|---------------------|--|---------------------------|--------|------------------------------|-------|----------------|-------|---|---|---------------------------------------|
| | | 50Hz | 60Hz | 50Hz | 60Hz | 50Hz | 60Hz | | | |
| 2 Form C |  6V AC | 349mA | 310mA | 2.09VA | 1.9VA | 0.051 | 0.049 | 80%V or less of nominal voltage (Initial) | 30%V or more of nominal voltage (Initial) | 110%V of nominal voltage |
| |  12V AC | 181.2mA | 160mA | 2.17VA | 1.9VA | 0.198 | 0.190 | | | |
| | 24V AC | 94mA | 78mA | 2.25VA | 1.9VA | 0.753 | 0.776 | | | |
| | 48V AC | 46.5mA | 39mA | 2.23VA | 1.9VA | 3.055 | 3.106 | | | |
| | 100V AC | 25.3mA | 21mA | 2.36VA | 2.1VA | 12.60 | 12.03 | | | |
| | 115V AC | 23.1mA | 18mA | 2.31VA | 2.1VA | 16.70 | 15.83 | | | |
| | 200V AC | 12.4mA | 11mA | 2.48VA | 2.2VA | 48.03 | 45.81 | | | |
| | 220V AC | 10.6mA | 9.5mA | 2.34VA | 2.1VA | 61.28 | 57.90 | | | |
| 240V AC | 10.0mA | 9.0mA | 2.40VA | 2.2VA | 69.00 | 66.26 | | | | |
| 3 Form C |  6V AC | 594mA | 520mA | 3.56VA | 3.1VA | 0.03 | 0.030 | 80%V or less of nominal voltage (Initial) | 30%V or more of nominal voltage (Initial) | 110%V of nominal voltage |
| |  12V AC | 297mA | 260mA | 3.56VA | 3.1VA | 0.123 | 0.119 | | | |
| | 24V AC | 148.7mA | 130mA | 3.56VA | 3.1VA | 0.0494 | 0.475 | | | |
| | 48V AC | 74.2mA | 65mA | 3.56VA | 3.1VA | 1.976 | 1.899 | | | |
| | 100V AC | 36.4mA | 32mA | 3.64VA | 3.2VA | 8.500 | 8.038 | | | |
| | 115V AC | 32.5mA | 28.5mA | 3.74VA | 3.3VA | 10.79 | 10.36 | | | |
| | 200V AC | 18.2mA | 16mA | 3.65VA | 3.2VA | 33.53 | 32.10 | | | |
| | 220V AC | 16.0mA | 14.2mA | 3.54VA | 3.1VA | 41.35 | 39.32 | | | |
| 240V AC | 15.8mA | 13.9mA | 3.79VA | 3.3VA | 45.94 | 44.05 | | | | |
| 4 Form C |  6V AC | 909mA | 800mA | 5.46VA | 4.8VA | 0.020 | 0.019 | 80%V or less of nominal voltage (Initial) | 30%V or more of nominal voltage (Initial) | 110%V of nominal voltage |
| |  12V AC | 456mA | 400mA | 5.47VA | 4.8VA | 0.080 | 0.077 | | | |
| | 24V AC | 229mA | 200mA | 5.49VA | 4.8VA | 0.320 | 0.309 | | | |
| | 48V AC | 108mA | 95mA | 5.18VA | 4.6VA | 1.348 | 1.292 | | | |
| | 100V AC | 57.3mA | 50mA | 5.73VA | 5.0VA | 5.348 | 5.156 | | | |
| | 115V AC | 47.6mA | 42mA | 5.47VA | 4.8VA | 7.264 | 6.953 | | | |
| | 200V AC | 28.5mA | 25mA | 5.69VA | 5.0VA | 21.27 | 20.45 | | | |
| | 220V AC | 23.8mA | 21mA | 5.24VA | 4.6VA | 27.75 | 26.57 | | | |
| 240V AC | 23.3mA | 20.5mA | 5.58VA | 4.9VA | 30.98 | 29.75 | | | | |

2) DC coils (20°C 68°F)

| Contact arrangement | Nominal coil voltage | Nominal coil current (mA) | Nominal operating power (W) | Coil resistance (Ω) | Pick-up voltage (at 20°C 68°F) | Drop-out voltage (at 20°C 68°F) | Max. allowable voltage (at 20°C 68°F) |
|---------------------|---|---------------------------|-----------------------------|---------------------|---|---|---------------------------------------|
| 2 Form C |  6V DC | 240mA | 1.5W | 25Ω | 80%V or less of nominal voltage (Initial) | 15%V or more of nominal voltage (Initial) | 110%V of nominal voltage |
| | 12V DC | 109mA | 1.3W | 110Ω | | | |
| | 24V DC | 54.5mA | 1.3W | 440Ω | | | |
| | 48V DC | 26.7mA | 1.3W | 1,800Ω | | | |
| | 100V DC | 14.9mA | 1.5W | 6,700Ω | | | |
| | 110V DC | 15.0mA | 1.7W | 7,300Ω | | | |
| 3 Form C |  6V DC | 250mA | 1.5W | 24Ω | 80%V or less of nominal voltage (Initial) | 15%V or more of nominal voltage (Initial) | 110%V of nominal voltage |
| | 12V DC | 120mA | 1.4W | 100Ω | | | |
| | 24V DC | 60mA | 1.4W | 400Ω | | | |
| | 48V DC | 31mA | 1.5W | 1,560Ω | | | |
| | 100V DC | 15.6mA | 1.6W | 6,400Ω | | | |
| | 110V DC | 14.9mA | 1.6W | 7,450Ω | | | |
| 4 Form C |  6V DC | 273mA | 1.6W | 22Ω | 80%V or less of nominal voltage (Initial) | 15%V or more of nominal voltage (Initial) | 110%V of nominal voltage |
| | 12V DC | 127mA | 1.5W | 95Ω | | | |
| | 24V DC | 63mA | 1.5W | 380Ω | | | |
| | 48V DC | 32.0mA | 1.5W | 1,500Ω | | | |
| | 100V DC | 16.3mA | 1.6W | 5,950Ω | | | |
| | 110V DC | 15.7mA | 1.7W | 7,000Ω | | | |

- Notes: 1. The rated current area is ±15% (60Hz) [AC coils], ±10% (20°C) [DC coils]
 2. The coil resistance for DC operation is the value measured when the coil temperature is 20°C 68°F. Compensate ±0.4% for every ±1°C change in temperature.
 3. The relay operates in a range of 80% to 110% V of the voltage rating, but ideally, in consideration of temporary voltage fluctuations, it should be operated at the rated voltage. In particular, for AC operation, if the impressed voltage drops to 80% V or more below the rated voltage, humming will occur and a large current will flow leading possibly to coil burnout.
 4. For use with 200 V DC, connect a 6.7kΩ (10W) resistor, in series, to the 100 V DC relay [3 Form C type is .6.4kΩ (5W); 4 Form C type is .6.2kΩ (10W)].
 5. As a general rule, only a pure DC voltage should be used for the coil drive.
 However, a DC power supply that contains ripples has characteristics that differ from pure DC.
 Therefore, please verify characteristics (operate voltage, release voltage, humming) using the actual circuit that will be used.

www.DataSheet4U.com
2. Specifications

| Characteristics | Item | Specifications | |
|----------------------------|---|--|--|
| Contact | Arrangement | 2 Form C, 3 Form C, 4 Form C | |
| | Initial contact resistance, max | Max. 15 mΩ (By voltage drop 6 V DC 1A) | |
| | Contact material | 2 Form C, 3 Form C 4 Form C Ag Ag alloy (cd free) | |
| Rating | Nominal switching capacity | 10A 250V AC (resistive load) | |
| | Min. switching capacity (Reference value)*1 | 100mA 5V DC | |
| Electrical characteristics | Insulation resistance (Initial) | Min. 100MΩ (at 500V DC) Measurement at same location as "Initial breakdown voltage" section. | |
| | Breakdown voltage (Initial) | Between open contacts | 1,000 Vrms for 1min (2 Form C, 4 Form C). 2,000 Vrms for 1min (3 Form C) (Detection current: 10mA.) |
| | | Between contact sets | 1,500 Vrms for 1min (2 Form C, 4 Form C). 2,000 Vrms for 1min (3 Form C) (Detection current: 10mA.) |
| | | Between contact and coil | 1,500 Vrms for 1min (2 Form C, 4 Form C). 2,000 Vrms for 1min (3 Form C) (Detection current: 10mA.) |
| | Temperature rise | Max. 65°C (By temperature method, at 40°C, nominal current) | |
| | Operate time*2 | Max. 25ms (2 Form C), Max.30ms (3 Form C, 4 Form C) (Nominal voltage applied to the coil, excluding contact bounce time.) | |
| | Release time*2 | Max. 25ms (2 Form C), Max.30ms (3 Form C, 4 Form C) (Nominal voltage applied to the coil, excluding contact bounce time.) (without diode) | |
| Mechanical characteristics | Shock resistance | Functional | Min. 98 m/s ² (Half-wave pulse of sine wave: 11 ms; detection time: 10μs.) |
| | | Destructive | Min. 980 m/s ² (Half-wave pulse of sine wave: 6 ms.) |
| | Vibration resistance | Functional | 10 to 55 Hz at double amplitude of 1 mm (Detection time: 10μs.) |
| | | Destructive | 10 to 55 Hz at double amplitude of 2 mm |
| Expected life | Mechanical | Min. 10 ⁷ | |
| Conditions | Conditions for operation, transport and storage*3 | Ambient temperature: -50°C to +40°C -58°F to +104°F Humidity: 5 to 85% R.H. (Not freezing and condensing at low temperature) | |
| | Max. Operating speed | 20 cpm (at max. rating) | |
| Unit weight | | 2 Form C: approx. 60g 2.12oz, 3 Form C: approx. 100g 3.53oz, 4 Form C: approx. 125g 4.41oz | |

Notes: *1 This value can change due to the switching frequency, environmental conditions and desired reliability level, therefore it is recommended to check this with the actual load.

*2 For the AC coil types, the operate/release time will differ depending on the phase.

*3 The upper operation ambient temperature limit is the maximum temperature that can satisfy the coil temperature rise value. Refer to 6. Conditions for operation, transport and storage mentioned in AMBIENT ENVIRONMENT.

3. Electrical life

1) AC load

| Voltage | 125V AC | | 250V AC | | Expected life |
|---------|------------------------|--------------------------|------------------------|--------------------------|------------------------|
| | Resistive (A) (cosφ=1) | Inductive (A) (cosφ=0.4) | Resistive (A) (cosφ=1) | Inductive (A) (cosφ=0.4) | |
| Current | — | — | 10 | 7.5 | Min. 2×10 ⁵ |
| | 10 | 7.5 | 7.5 | 5 | Min. 5×10 ⁵ |
| | 5 | 3 | 3 | 2 | Min. 10 ⁶ |
| | 1 | 0.7 | 0.6 | 0.4 | Min. 2×10 ⁶ |

Note: When the electromagnet or exciting coil (Solenoid, etc.) is the load, the value of motor or lamp load is applicable.

2) DC load

| Voltage | 24V DC | | 125V DC | | Expected life |
|---------|---------------|---------------|---------------|---------------|------------------------|
| | Resistive (A) | Inductive (A) | Resistive (A) | Inductive (A) | |
| Current | — | 7 | — | — | Min. 2×10 ⁵ |
| | 7.5 | 5 | 0.5 | 0.4 | Min. 5×10 ⁵ |
| | 5 | 3 | 0.3 | 0.2 | Min. 10 ⁶ |
| | 1 | 0.6 | 0.1 | 0.06 | Min. 2×10 ⁶ |

Note: For DC inductive loads, use an arc suppressing circuit.

Note: Cautions at DC load use

When used under a DC load operating at high repetition rate with considerable arcing, corrosion of the contacts and/or the contact blades is likely to occur.

4. Life of LED and neon lamp (with operation indication)

| | | |
|---------------------|----------------------------------|----------------------------------|
| | Continuous | Use rating (ON time) 50% |
| With neon lamp | 25,000 hours (approx. 3 years) | Approx. 6 years |
| With LED indication | 50,000 hours (approx. 5.5 years) | 100,000 hours (approx. 11 years) |

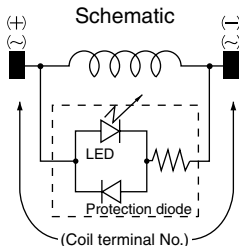
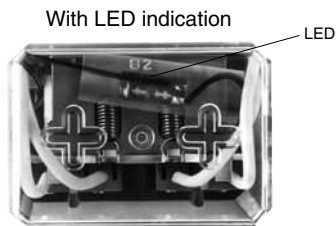
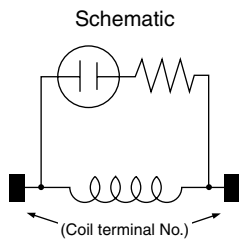
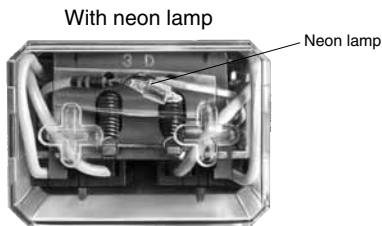

Coil terminal No. and polarity (DC type)

| | Polarity | HP2 | HP3 | HP4 |
|--------------|----------|-----|-----|-----|
| Terminal No. | (+) | 7 | 10 | 10 |
| | (-) | 2 | 2 | 1 |

REFERENCE DATA

1. Life curve

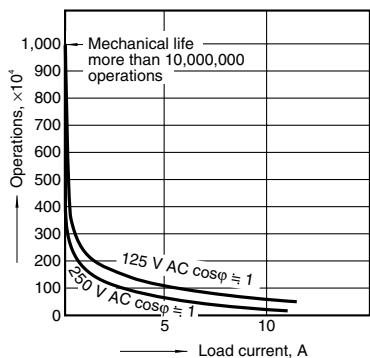

2. Max. switching capacity

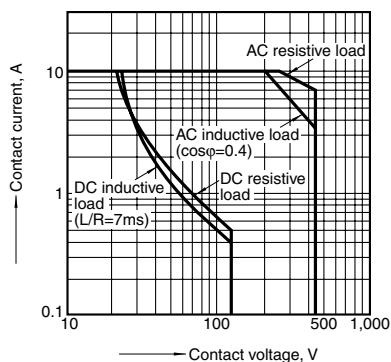

DIMENSIONS (Unit: mm inch)

Plug-in type (2 Form C)



External dimensions

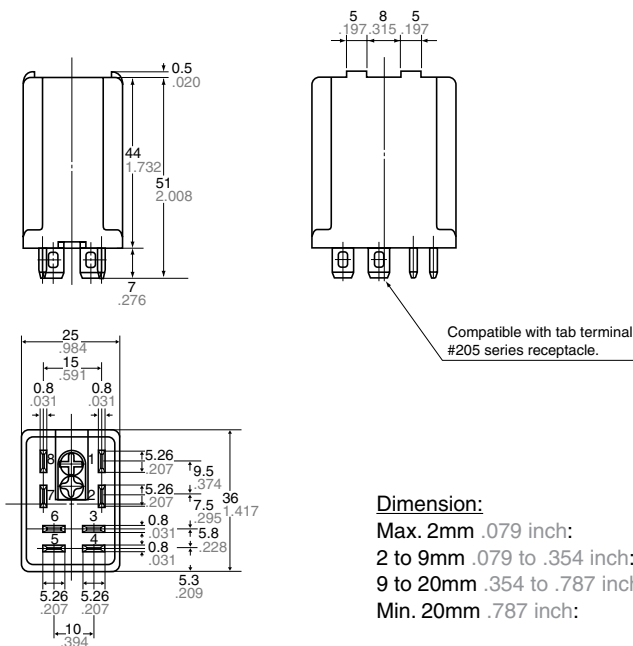

Schematic (Bottom view)

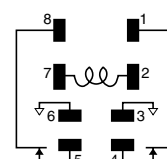

| Dimension: | Tolerance |
|------------|-------------------------------|
| Max. 2mm | .079 inch: ±0.2 ±.008 |
| 2 to 9mm | .079 to .354 inch: ±0.5 ±.020 |
| 9 to 20mm | .354 to .787 inch: ±1 ±.039 |
| Min. 20mm | .787 inch: ±1.5 ±.059 |

www.DataSheet4U.com **Plug-in type (3 Form C)**



External dimensions

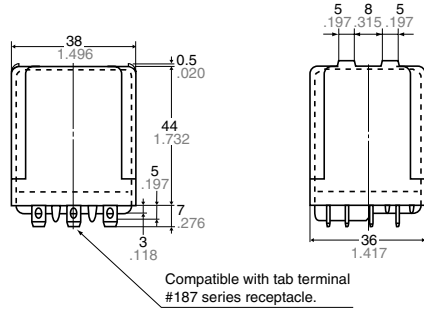

Schematic (Bottom view)

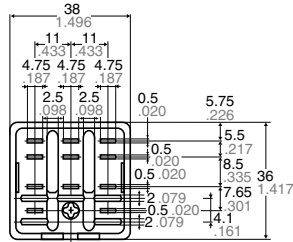
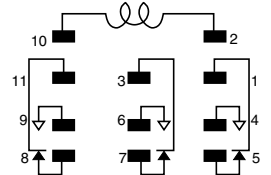

| Dimension: | Tolerance |
|------------------------------|--------------------|
| Max. 2mm .079 inch: | $\pm 0.2 \pm 0.08$ |
| 2 to 9mm .079 to .354 inch: | $\pm 0.5 \pm 0.20$ |
| 9 to 20mm .354 to .787 inch: | $\pm 1 \pm 0.39$ |
| Min. 20mm .787 inch: | $\pm 1.5 \pm 0.59$ |

Plug-in type (4 Form C)



External dimensions

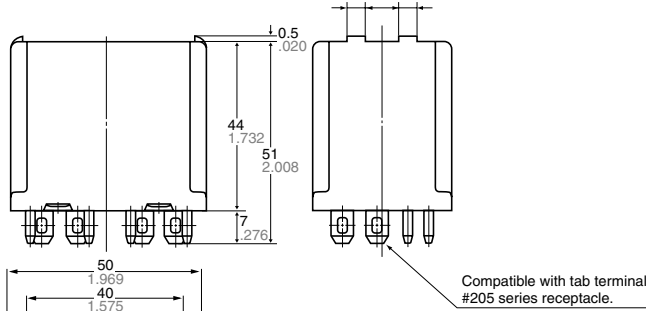

Schematic (Bottom view)

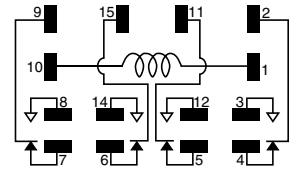

| Dimension: | Tolerance |
|------------------------------|--------------------|
| Max. 2mm .079 inch: | $\pm 0.2 \pm 0.08$ |
| 2 to 9mm .079 to .354 inch: | $\pm 0.5 \pm 0.20$ |
| 9 to 20mm .354 to .787 inch: | $\pm 1 \pm 0.39$ |
| Min. 20mm .787 inch: | $\pm 1.5 \pm 0.59$ |

TM type
(2 Form C)



Dimension:
 Max. 2mm .079 inch:
 2 to 9mm .079 to .354 inch:
 9 to 20mm .354 to .787 inch:
 Min. 20mm .787 inch:

Tolerance
 $\pm 0.2 \pm .008$
 $\pm 0.5 \pm .020$
 $\pm 1 \pm .039$
 $\pm 1.5 \pm .059$

External dimensions

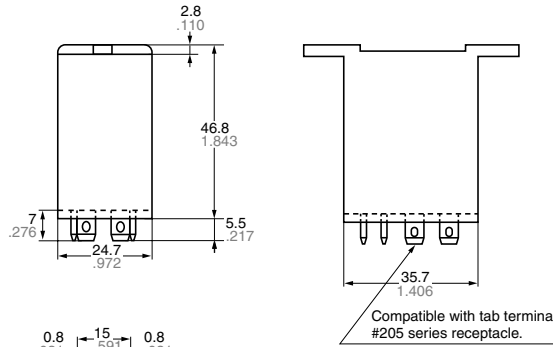

Mounting hole diagram

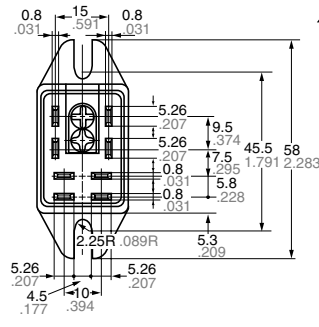
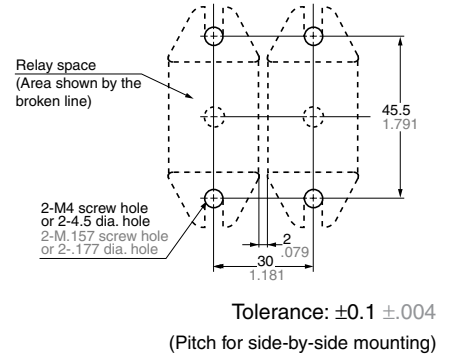

Schematic (Bottom view)

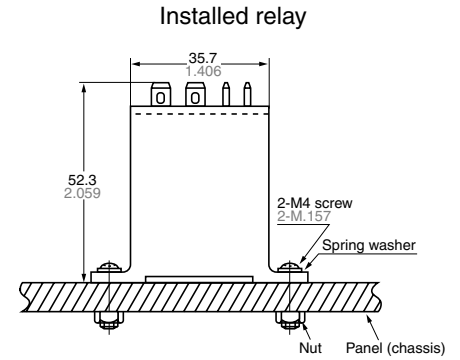
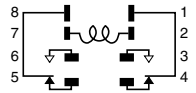

Direct mounting type
(3 Form C)



Dimension:
 Max. 2mm .079 inch:
 2 to 9mm .079 to .354 inch:
 9 to 20mm .354 to .787 inch:
 Min. 20mm .787 inch:

Tolerance
 $\pm 0.2 \pm .008$
 $\pm 0.5 \pm .020$
 $\pm 1 \pm .039$
 $\pm 1.5 \pm .059$

External dimensions

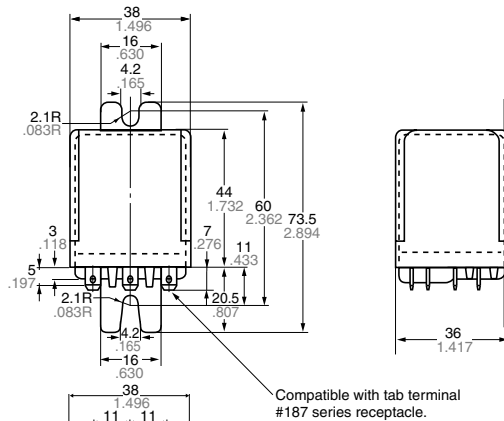

Mounting hole diagram

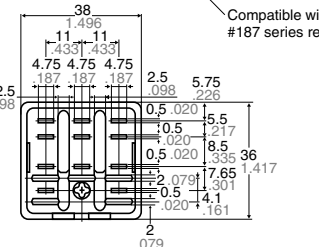
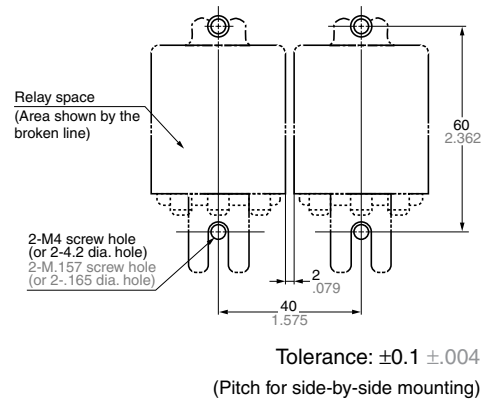

Schematic (Bottom view)

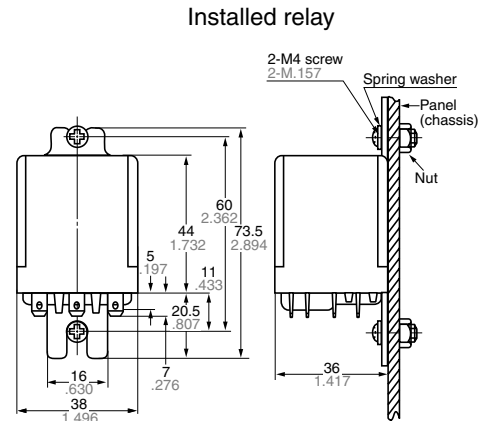
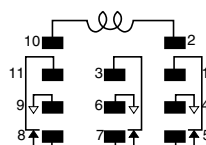

ACCESSORIES (Sockets and Terminal sockets)

HP RELAY

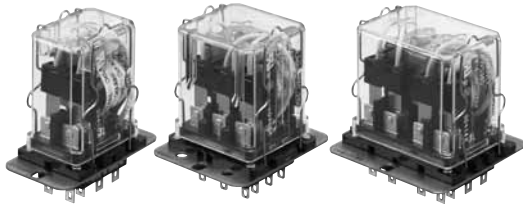

Socket for rectangular hold boring

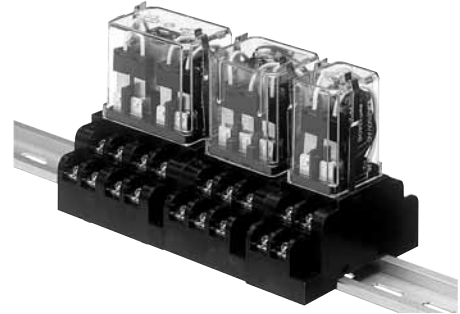

Terminal socket for DIN rail assembly

RoHS Directive compatibility information
<http://www.mew.co.jp/ac/e/environment/>

TYPES

1. For DIN rail terminal sockets, hold-down clip included.
2. For square hole sockets, powerful hold-down clip included.

| Type | No. of poles | Item | Part No. | Packing quantity | |
|--------------------------|---------------------|------------------------------|----------|------------------|----------|
| | | | | Carton | Case |
| Square hole socket | 2-pole | HP2-square hole socket | HP2-SRS | 20 pcs. | 100 pcs. |
| | 3-pole | HP3-square hole socket | HP3-SRS | 10 pcs. | 50 pcs. |
| | 4-pole | HP4-square hole socket | HP4-SRS | 10 pcs. | 50 pcs. |
| DIN rail terminal socket | 2-pole | HP2-DIN terminal socket | HP2-SFD | 10 pcs. | 50 pcs. |
| | 3-pole | HP3-DIN terminal socket | HP3-SFD | 10 pcs. | 50 pcs. |
| | 4-pole | HP4-DIN terminal socket | HP4-SFD | 5 pcs. | 25 pcs. |
| Common part | 2/3/4-pole (common) | HP-hold down clip for socket | AW5806 | — | 50 pcs. |

Note: Socket and terminal socket conform to UL, CSA as standard.

HP RELAY ACCESSORIES

DIMENSIONS^m (Unit: mm inch)

1. Socket for rectangular hold boring (hold-down clip included)

HP2-Socket (HP2-SRS)



Front surface mounting

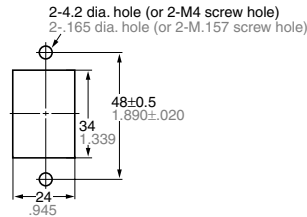

When the socket is mounted from the top of the panel (chassis).

Tolerance: $\pm 0.1 \pm .004$

Mounting dimensions

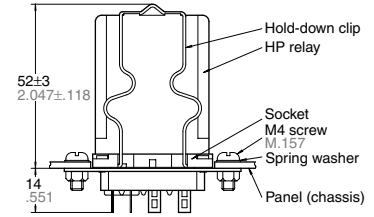

External dimensions

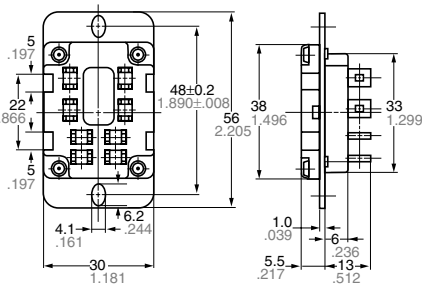

General tolerance: $\pm 0.1 \pm .004$

Rear surface mounting

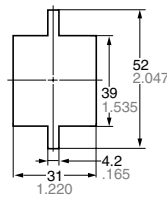

When the socket is mounted from below the panel (chassis).

Tolerance: $\pm 0.1 \pm .004$

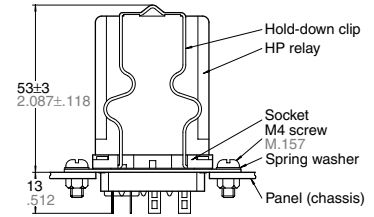

- Notes: 1. Optimum space-saving panel cut-out.
2. Can be mounted from either the front or the rear of the panel.
3. Hold-down clip is included in package.

HP3-Socket (HP3-SRS)



Front surface mounting

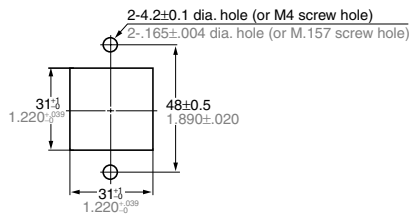

Tolerance: $\pm 0.1 \pm .004$

Mounting dimensions

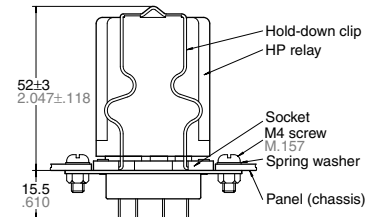

External dimensions

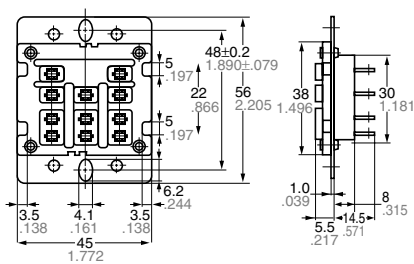

General tolerance: $\pm 0.1 \pm .004$

Rear surface mounting

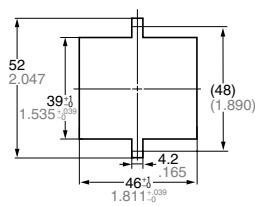

Tolerance: $\pm 0.1 \pm .004$

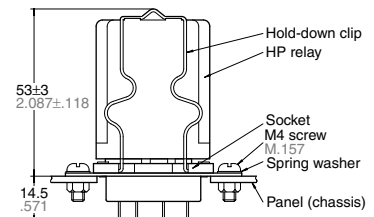

- Notes: 1. Optimum space-saving panel cut-out.
2. Can be mounted from either the front or the rear of the panel.
3. Hold-down clip is included in package.

HP RELAY ACCESSORIES

HP4- Socket (HP4-SRS)



Front surface mounting

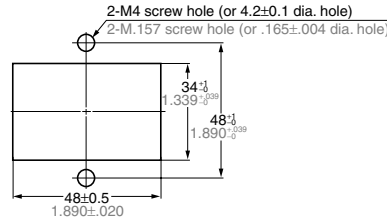

Tolerance: $\pm 0.1 \pm .004$

Mounting dimensions

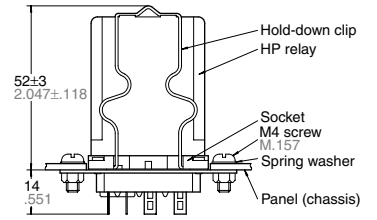

External dimensions

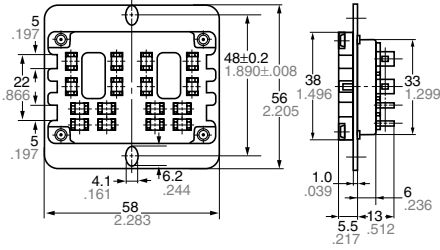

General tolerance: $\pm 0.1 \pm .004$

Rear surface mounting

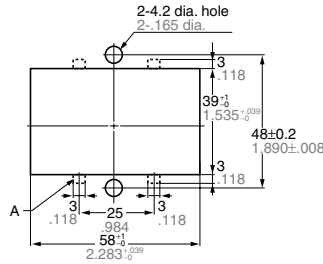

Tolerance: $\pm 0.1 \pm .004$

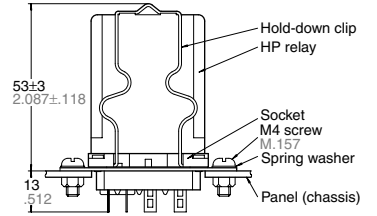

- Notes: 1. Optimum space-saving panel cut-out.
2. Can be mounted from either the front or the rear of the panel.
3. Hold-down clip is included in package.

* When using the former hold-down clip, it is necessary to cut out the A section marked by the broken line (not necessary with the powerful hold-down clip).

2. Terminal socket for DIN rail assembly (hold-down clip and installation screw included)

HP2-Terminal socket for DIN rail assembly (HP2-SFD)



External dimensions

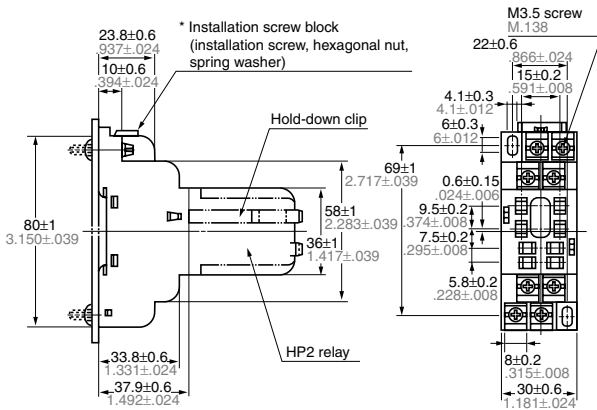

Schematic

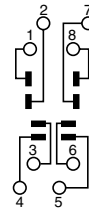

Mounting hole diagram

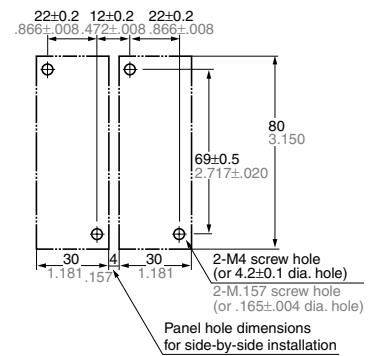

- Notes: 1. For direct mounting, use the included installation screw block.
2. A hold-down clip is included with the terminal socket.

HP RELAY ACCESSORIES

HP3-Terminal socket for DIN rail assembly (HP3-SFD)

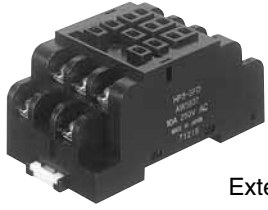

External dimensions

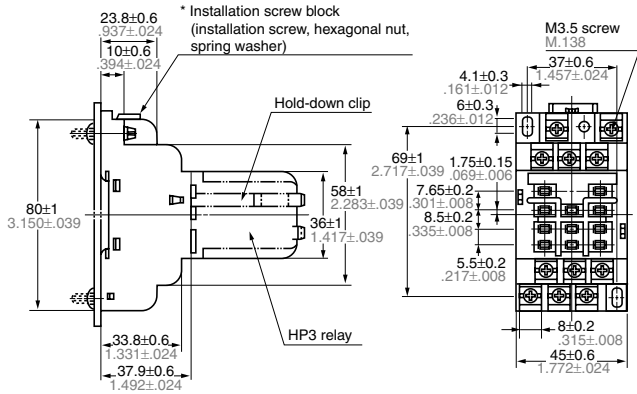

Schematic

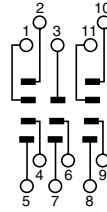

Mounting hole diagram

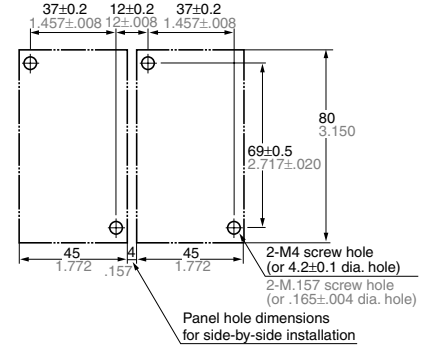

- Notes: 1. For direct mounting, use the included installation screw block.
2. A hold-down clip is included with the terminal socket.

HP4-Terminal socket for DIN rail assembly (HP4-SFD)

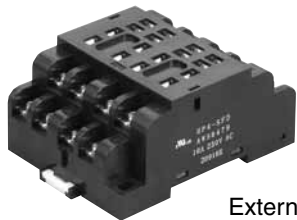

External dimensions

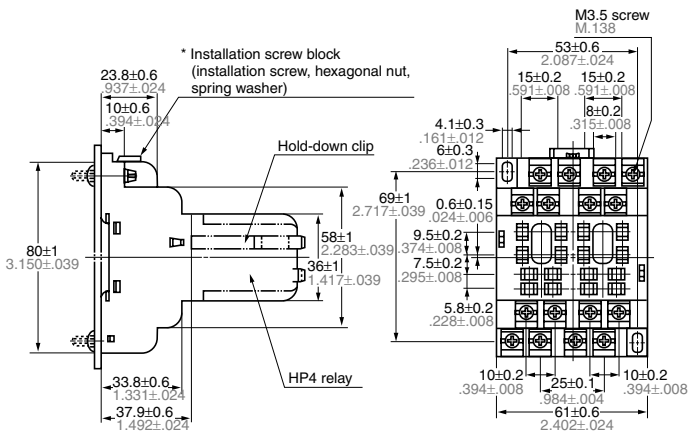

Schematic

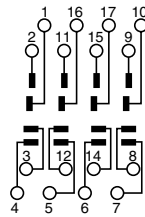

Mounting hole diagram

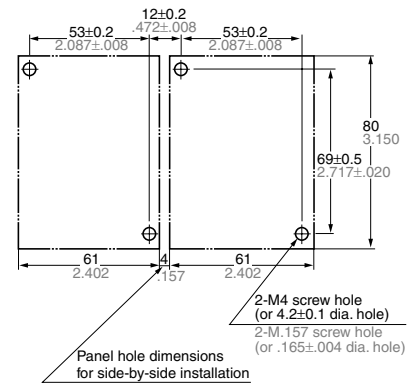

- Notes: 1. For direct mounting, use the included installation screw block.
2. A hold-down clip is included with the terminal socket.

NOTES

1. There are two types of HP relay: plug-in and direct mounting (HP2-TM and HP3-M only).

Avoid use of direct mounting types in sockets or terminal sockets.

Note: Mounting measurements for direct mounting types (HP2-TM and HP3-M) are shown in the drawing on page 146.

2. The terminals are compatible with tab terminals. Consequently, for direct mounting types, in addition to soldering, AMP terminals can be used.

| Part number | Compatible tab terminal |
|-------------|-------------------------|
| HP2 | #205 series |
| HP3 | #187 series |
| HP4 | #205 series |

3. When tightening the fixing screws of direct mounting types, use washers to prevent damage or distortion.

The optimum torque range is 0.49 to 0.69 N·m, (5 to 7 kgf·cm).

To prevent loosening of direct mounting types, terminal sockets and sockets, etc., when fixing the screws, use spring washers, etc. Moreover, wiring (soldering), should be done with care while ensuring strong connections.

4. When tightening terminal socket fixing screws, to prevent damage, the optimum torque range should be 0.784 to 0.98 N·m, (8 to 10 kgf·cm).

5. Avoid use in adverse conditions, such as where the relay will be subjected to strong vibrations or shock, where there is exposure to harmful gas, or where ambient temperatures are high (more than 40°C).

6. Use in DC load

Abnormal wear of the contacts and contact springs will occur when the switching frequency is high and there are large arcs. In particular, if high-frequency operation in hot or humid conditions is intended, use arc-suppressing circuits.

7. There is no particular specification for HP relay mounting orientation.

8. Do not insert or remove relays into or out of live circuits.

For Cautions for Use, see Relay Technical Information.