

HPI - 1KL5

The HPI - 1KL5, a silicon PIN photodiode mounted in durable, hermetically sealed TO - 18 metal can package, provides years of reliable performance even under demanding conditions such as use outdoors.

FEATURES

- TO - 18 can type with glass lens
- High speed response
- High reliability

APPLICATIONS

- Optical transmissions
- Optical switches
- Precise optical equipment

DIMENSIONS

(Unit : mm)

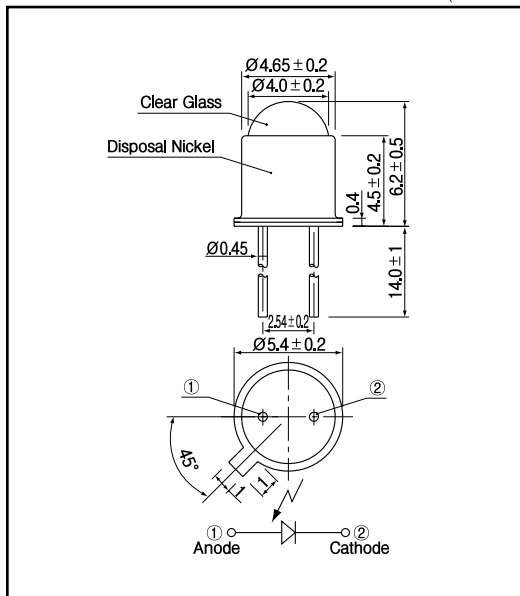

MAXIMUM RATINGS

(Ta=25)

Item	Symbol	Rating	Unit
Reverse voltage	V_R	40	V
Power dissipation	P_o	100	mW
Operating temp.	$T_{opr.}$	- 25 + 100	
Storage temp.	$T_{stg.}$	- 40 + 110	
Soldering temp.*1	$T_{sol.}$	260	

*1.For MAX.5 seconds at the position of 2 mm from the package

ELECTRO-OPTICAL CHARACTERISTICS

(Ta=25)

Item	Symbol	Conditions	Min.	Typ.	Max.	Unit.
Open circuit voltage	V_{oc}	$E_v = 1,000lx^2$		0.4		V
Short circuit current	I_{sc}	$E_v = 1,000lx^2$	65	85		μA
Curve factor	C.F.		0.55			—
Dark current	I_d	$V_R = 5V$			0.1	μA
Capacitance	C_t	$V = 0V, f = 1MHz$		10		pF
Temperature coefficient of V_{oc}	t			- 2.2		mV/
Temperature coefficient of I_{sc}	t			0.18		%/
Spectral sensitivity				450 1050		nm
Peak wavelength	ρ			920		nm
Half angle		$I_f = 20mA$		± 6		deg.

*2.Color temp.=2856K standard Tungsten lamp

PIN Photodiode

HPI - 1KL5

Light current Vs. Forward voltage

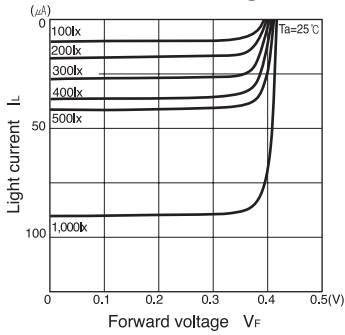

Short circuit current I_sc Vs. Illuminance E_v

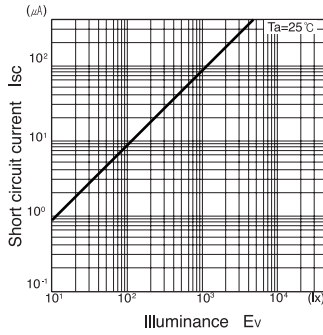

Dark current I_d Vs. Ambient temperature T_a

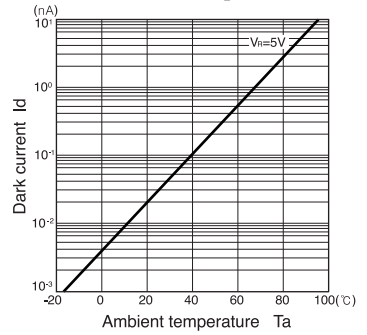

Relative sensitivity S Vs. Wavelength λ

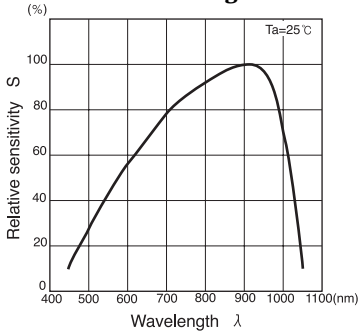

Dark current I_d Vs. Reverse voltage V_R

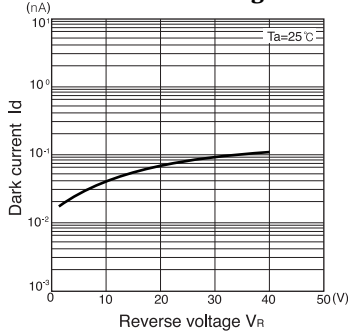

Radiant Pattern

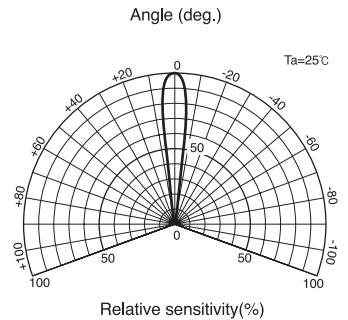

Capacitance between terminals C_t Vs. Reverse voltage V_R

