

HPI - 6FGR4

The HPI - 6FGR4 is a high - output, high - speed silicon photodiode mounted in a side - viewing plastic package with visible light cutoff filter. This photodiode is both compact and easy to mount.

FEATURES

- Compact visible ray widely cut off mold type
- High speed response

APPLICATIONS

- Optical transmission
- Optic receiver modules

DIMENSIONS

(Unit : mm)

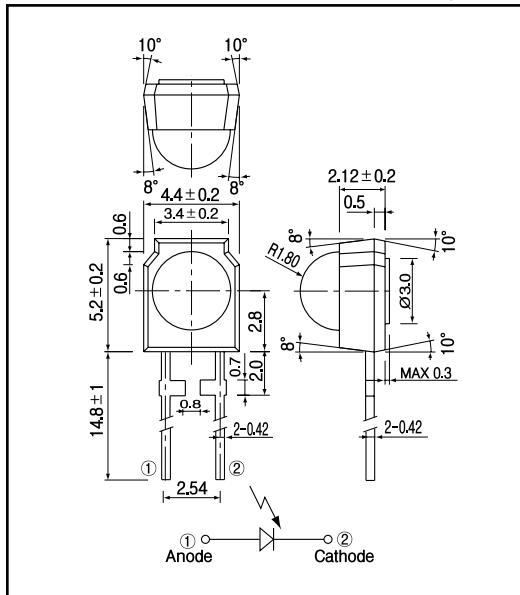

MAXIMUM RATINGS

(Ta=25)

Item	Symbol	Rating	Unit
Reverse voltage	V _r	35	V
Power dissipation	P _b	150	mW
Operating temp.	T _{opr.}	- 30 +70	
Storage temp.	T _{stg.}	- 40 +80	
Soldering temp.*1	T _{sol.}	260	

*1.For MAX.5 seconds at the position of 2 mm from the package

ELECTRO-OPTICAL CHARACTERISTICS

(Ta=25)

Item	Symbol	Conditions	Min.	Typ.	Max.	Unit.
Open circuit voltage	V _{oc}	E _v = 1,000lx ²		0.38		V
Short circuit current	I _{sc}	E _v = 1,000lx ²		24		μA
Curve factor	C.F.		0.55			—
Dark current	I _d	V _r = 10V			10	nA
Capacitance	C _t	V = 0V, f = 1MHz		24		pF
Temperature coefficient of Voc	t			- 2.2		mV/
Temperature coefficient of Isc	t			0.18		%/
Spectral sensitivity				880 1050		nm
Peak wavelength	λ			1,000		nm
Half angle				± 40		deg.

*2.Color temp.=2856K standard Tungsten lamp

PIN Photodiode

HPI - 6FGR4

Light current Vs. Forward voltage

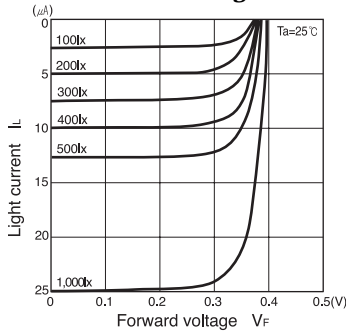

Short circuit current Vs. Illuminance

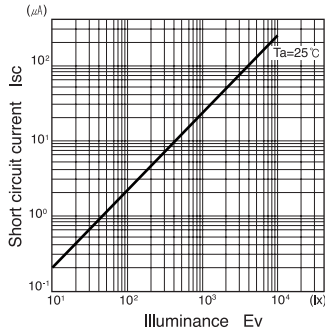

Dark current Vs. Ambient temperature

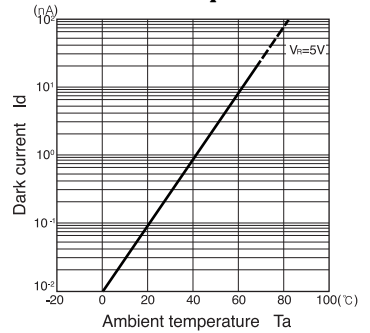

Relative sensitivity Vs. Wavelength

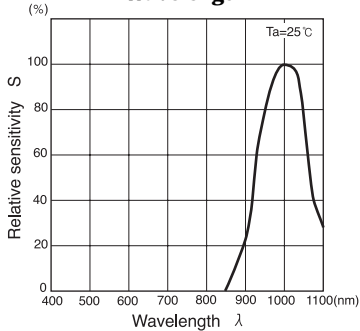

Dark current Vs. Reverse voltage

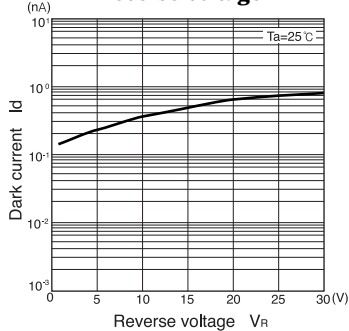

Radiant Pattern

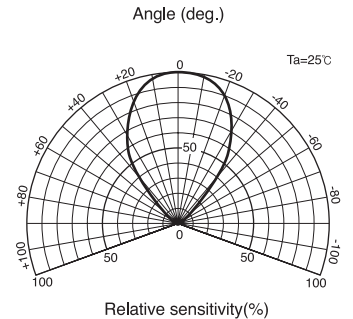

Capacitance between terminals Vs. Reverse voltage

