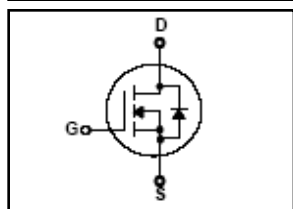
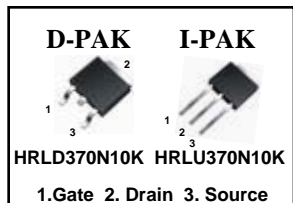


## HRLD370N10K / HRLU370N10K 100V N-Channel Trench MOSFET

$BV_{DSS} = 100\text{ V}$   
 $R_{DS(on) \text{ typ}} = 30\text{ m}\Omega$   
 $I_D = 25\text{ A}$

### FEATURES

- Originative New Design
- Superior Avalanche Rugged Technology
- Excellent Switching Characteristics
- Unrivalled Gate Charge : 53 nC (Typ.)
- Extended Safe Operating Area
- Lower  $R_{DS(ON)}$  : 30 m $\Omega$  (Typ.) @  $V_{GS}=10\text{V}$
- Lower  $R_{DS(ON)}$  : 33 m $\Omega$  (Typ.) @  $V_{GS}=4.5\text{V}$
- 100% Avalanche Tested



### Absolute Maximum Ratings $T_C=25^\circ\text{C}$ unless otherwise specified

Symbol	Parameter	Value	Units
$V_{DSS}$	Drain-Source Voltage	100	V
$I_D$	Drain Current – Continuous ( $T_C = 25^\circ\text{C}$ )	25 *	A
	Drain Current – Continuous ( $T_C = 100^\circ\text{C}$ )	17.5 *	A
$I_{DM}$	Drain Current – Pulsed (Note 1)	88 *	A
$V_{GS}$	Gate-Source Voltage	$\pm 20$	V
$E_{AS}$	Single Pulsed Avalanche Energy (Note 2)	80	mJ
$E_{AR}$	Repetitive Avalanche Energy (Note 1)	4.8	mJ
$P_D$	Power Dissipation ( $T_A = 25^\circ\text{C}$ )*	3	W
	Power Dissipation ( $T_C = 25^\circ\text{C}$ ) - Derate above $25^\circ\text{C}$	48	W
		0.32	W/ $^\circ\text{C}$
$T_J, T_{STG}$	Operating and Storage Temperature Range	-55 to +175	$^\circ\text{C}$
$T_L$	Maximum lead temperature for soldering purposes, 1/8" from case for 5 seconds	300	$^\circ\text{C}$

\* Drain current limited by maximum junction temperature

### Thermal Resistance Characteristics

Symbol	Parameter	Typ.	Max.	Units
$R_{\theta JC}$	Junction-to-Case	--	3.1	$^\circ\text{C}/\text{W}$
$R_{\theta JA}$	Junction-to-Ambient*	--	50	
$R_{\theta JA}$	Junction-to-Ambient	--	110	

\* When mounted on the minimum pad size recommended (PCB Mount)

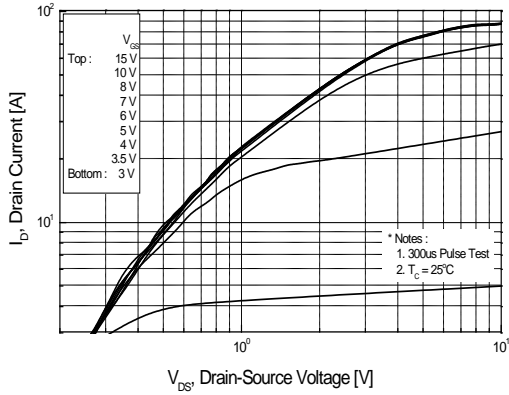
**Electrical Characteristics**  $T_J=25^\circ\text{C}$  unless otherwise specified

Symbol	Parameter	Test Conditions	Min	Typ	Max	Units
<b>On Characteristics</b>						
$V_{GS}$	Gate Threshold Voltage	$V_{DS} = V_{GS}, I_D = 250 \mu\text{A}$	1.0	--	2.4	V
$R_{DS(ON)}$	Static Drain-Source On-Resistance	$V_{GS} = 10 \text{ V}, I_D = 12 \text{ A}$	--	30	37	m $\Omega$
		$V_{GS} = 4.5 \text{ V}, I_D = 10 \text{ A}$	--	33	42	m $\Omega$
$g_{FS}$	Forward Transconductance	$V_{DS} = 15 \text{ V}, I_D = 12 \text{ A}$	--	60	--	S
<b>Off Characteristics</b>						
$BV_{DSS}$	Drain-Source Breakdown Voltage	$V_{GS} = 0 \text{ V}, I_D = 250 \mu\text{A}$	100	--	--	V
$I_{DSS}$	Zero Gate Voltage Drain Current	$V_{DS} = 80 \text{ V}, V_{GS} = 0 \text{ V}$	--	--	1	$\mu\text{A}$
		$V_{DS} = 80 \text{ V}, T_J = 125^\circ\text{C}$	--	--	100	$\mu\text{A}$
$I_{GSS}$	Gate-Body Leakage Current	$V_{GS} = \pm 20 \text{ V}, V_{DS} = 0 \text{ V}$	--	--	$\pm 100$	nA
<b>Dynamic Characteristics</b>						
$C_{iss}$	Input Capacitance	$V_{DS} = 25 \text{ V}, V_{GS} = 0 \text{ V}, f = 1.0 \text{ MHz}$	--	2500	--	pF
$C_{oss}$	Output Capacitance		--	140	--	pF
$C_{rss}$	Reverse Transfer Capacitance		--	100	--	pF
$R_g$	Gate Resistance	$V_{GS} = 0 \text{ V}, V_{DS} = 0 \text{ V}, f = 1\text{MHz}$	--	1.4	--	$\Omega$
<b>Switching Characteristics</b>						
$t_{d(on)}$	Turn-On Time	$V_{DS} = 50 \text{ V}, I_D = 12 \text{ A}, R_G = 6 \Omega$	--	24	--	ns
$t_r$	Turn-On Rise Time		--	20	--	ns
$t_{d(off)}$	Turn-Off Delay Time		--	135	--	ns
$t_f$	Turn-Off Fall Time		--	25	--	ns
$Q_g$	Total Gate Charge	$V_{DS} = 80 \text{ V}, I_D = 12 \text{ A}, V_{GS} = 10 \text{ V}$	--	53	--	nC
$Q_{gs}$	Gate-Source Charge		--	7	--	nC
$Q_{gd}$	Gate-Drain Charge		--	13	--	nC
<b>Source-Drain Diode Maximum Ratings and Characteristics</b>						
$I_S$	Continuous Source-Drain Diode Forward Current		--	--	25	A
$I_{SM}$	Pulsed Source-Drain Diode Forward Current		--	--	88	
$V_{SD}$	Source-Drain Diode Forward Voltage	$I_S = 12 \text{ A}, V_{GS} = 0 \text{ V}$	--	--	1.1	V
$t_{rr}$	Reverse Recovery Time	$I_S = 12 \text{ A}, V_{GS} = 0 \text{ V}, di_F/dt = 100 \text{ A}/\mu\text{s}$	--	50	--	ns
$Q_{rr}$	Reverse Recovery Charge		--	70	--	nC

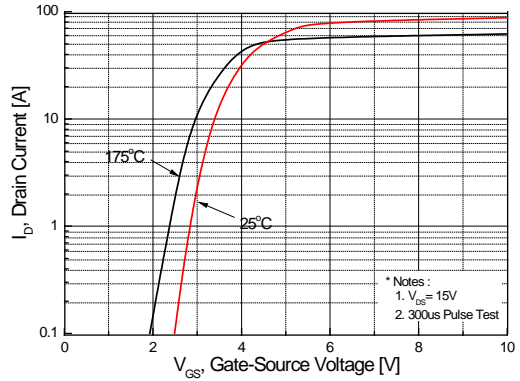
**Notes :**

1. Repetitive Rating : Pulse width limited by maximum junction temperature
2.  $L=1\text{mH}, I_{AS}=11\text{A}, V_{DD}=25\text{V}, R_G=25\Omega$ , Starting  $T_J=25^\circ\text{C}$

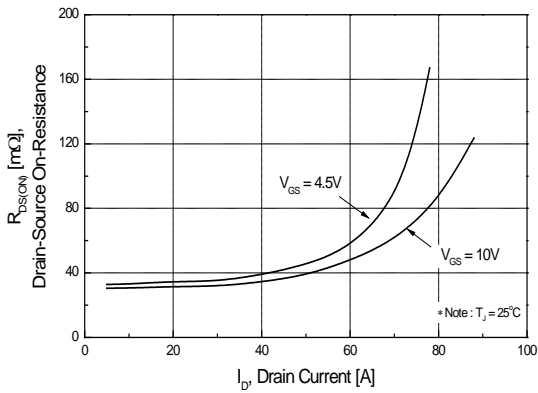
## Typical Characteristics



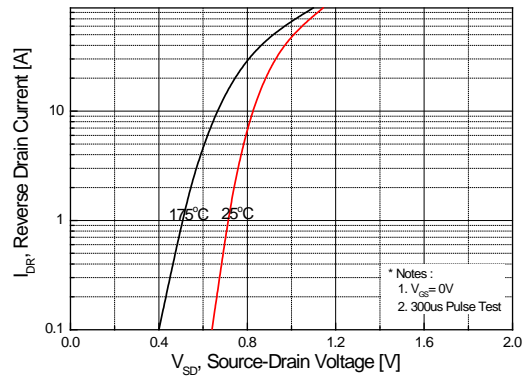
**Figure 1. On Region Characteristics**



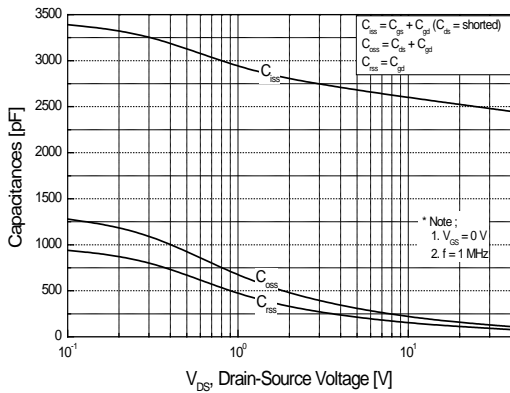
**Figure 2. Transfer Characteristics**



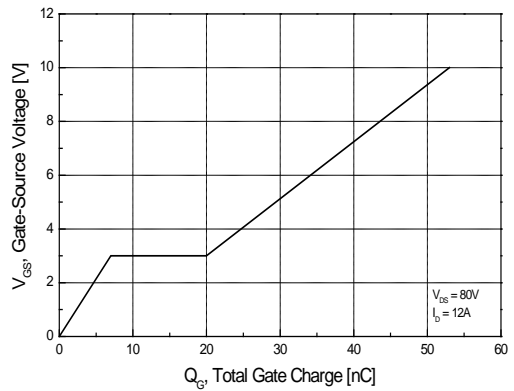
**Figure 3. On Resistance Variation vs Drain Current and Gate Voltage**



**Figure 4. Body Diode Forward Voltage Variation with Source Current and Temperature**

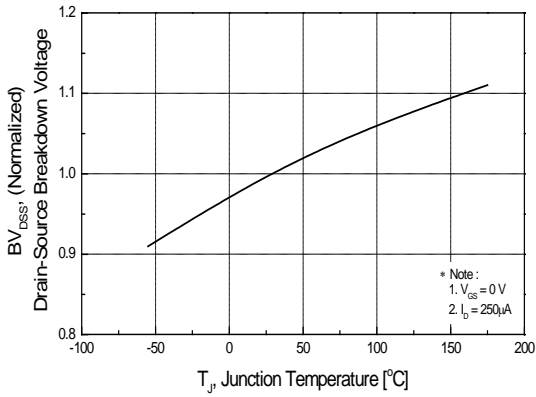


**Figure 5. Capacitance Characteristics**

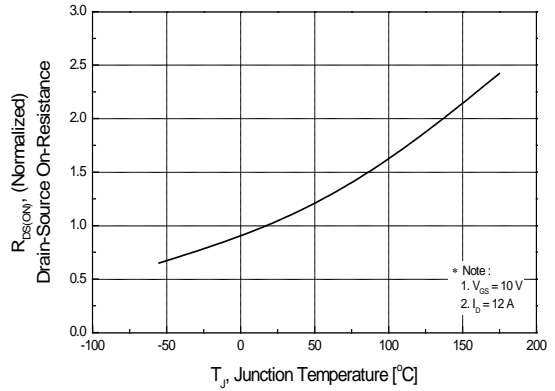


**Figure 6. Gate Charge Characteristics**

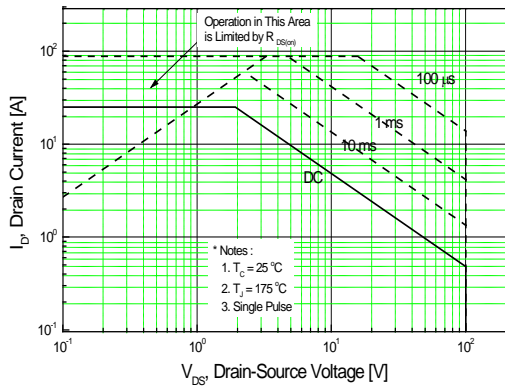
**Typical Characteristics (continued)**



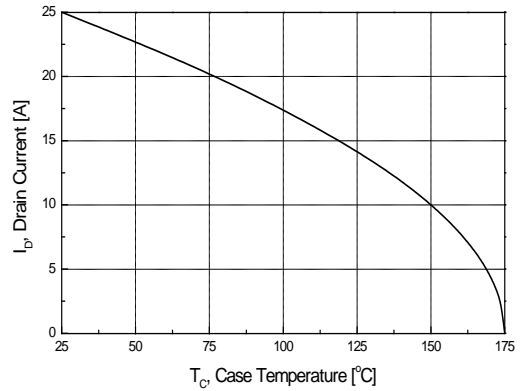
**Figure 7. Breakdown Voltage Variation vs Temperature**



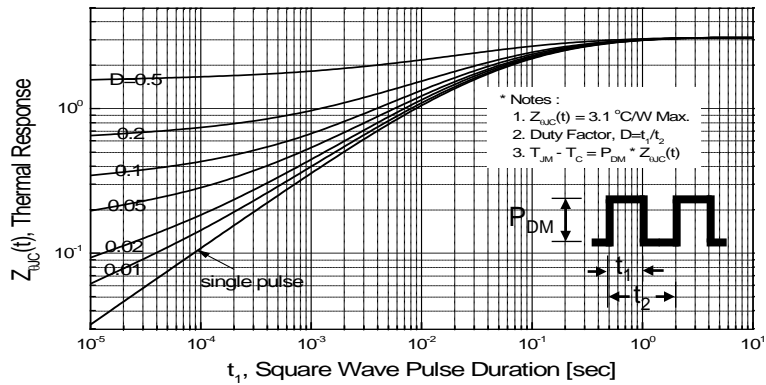
**Figure 8. On-Resistance Variation vs Temperature**



**Figure 9. Maximum Safe Operating Area**

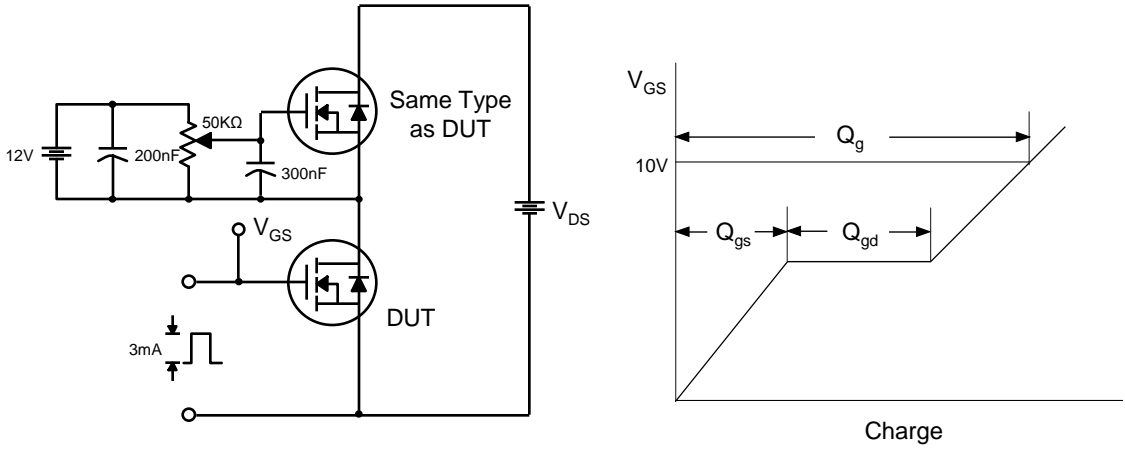


**Figure 10. Maximum Drain Current vs Case Temperature**

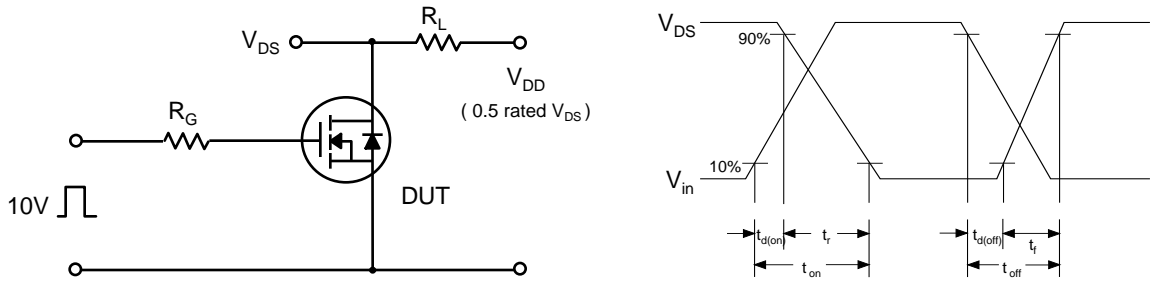


**Figure 11. Transient Thermal Response Curve**

**Fig 12. Gate Charge Test Circuit & Waveform**



**Fig 13. Resistive Switching Test Circuit & Waveforms**



**Fig 14. Unclamped Inductive Switching Test Circuit & Waveforms**

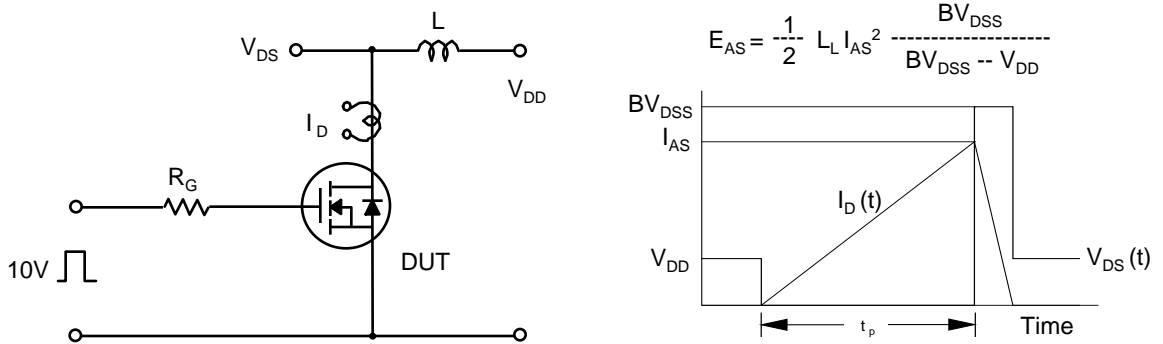
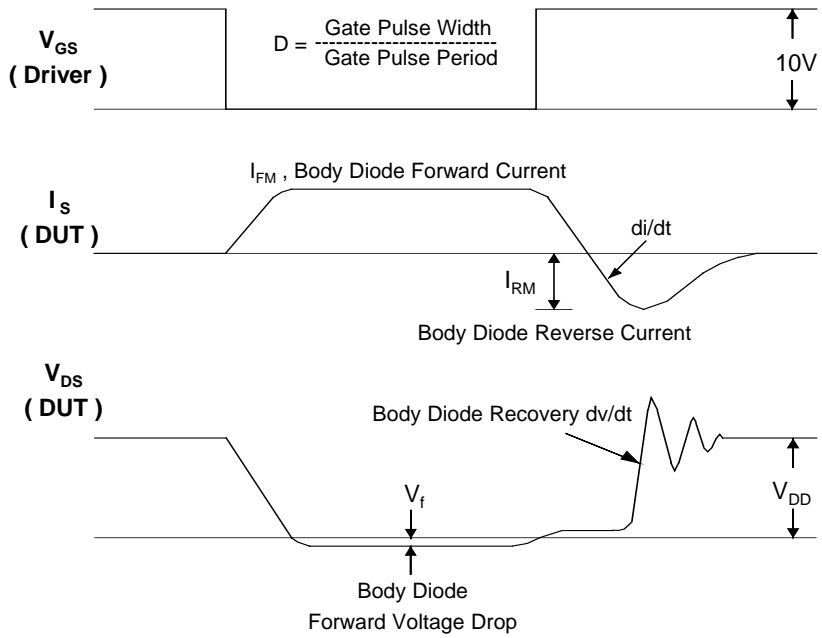
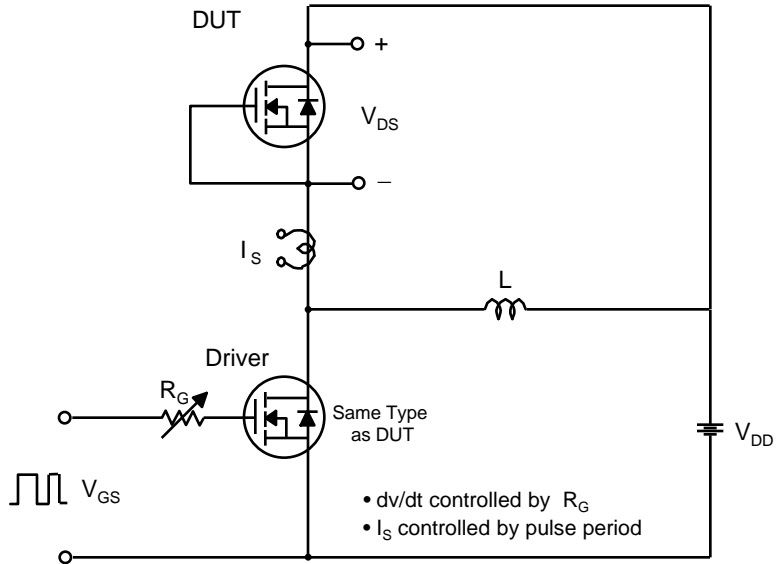


Fig 15. Peak Diode Recovery dv/dt Test Circuit & Waveforms



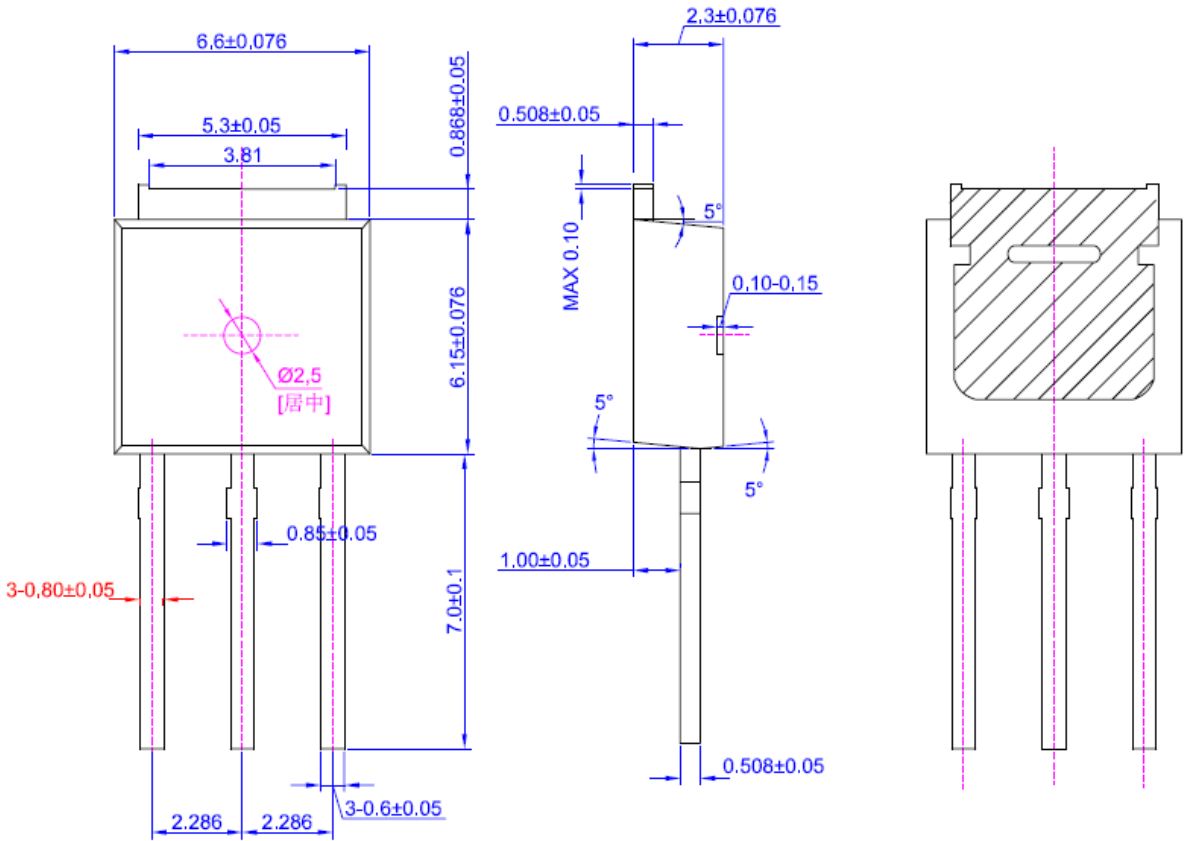
Package Dimension

TO-252  
(Ass'y GZSM)



Package Dimension

TO-251  
(Ass'y GZSM)





Package Dimension

TO-251  
(Ass'y CLD)

