

# HRLF43N06H

## 60V N-Channel Trench MOSFET

### Features

- Optimized for High Speed Switching, Logic Level
- Enhanced Body diode dv/dt capability
- Enhanced Avalanche Ruggedness
- 100% UIS Tested, 100% Rg Tested
- Lead free, Halogen Free

### Application

- Synchronous Rectification in SMPS
- Hard Switching and High Speed Circuit
- Power Tools
- UPS, Motor Control

### Key Parameters

Parameter	Value	Unit
$BV_{DSS}$	60	V
$I_D$	120	A
$R_{DS(on), typ @10V}$	3.6	m $\Omega$
$R_{DS(on), typ @4.5V}$	4.6	m $\Omega$

### Package & Internal Circuit

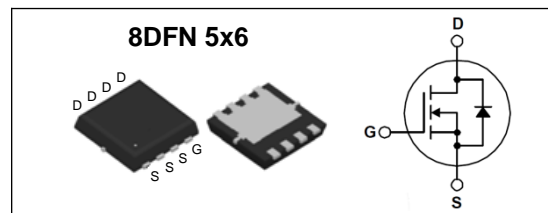

### Absolute Maximum Ratings $T_J=25^\circ\text{C}$ unless otherwise specified

Symbol	Parameter	Value	Units	
$V_{DSS}$	Drain-Source Voltage	60	V	
$V_{GS}$	Gate-Source Voltage	$\pm 20$	V	
$I_D$	Drain Current	$T_C = 25^\circ\text{C}$	120	A
		$T_C = 100^\circ\text{C}$	76	A
$I_{DM}$	Pulsed Drain Current	350	A	
$E_{AS}$	Single Pulsed Avalanche Energy	L=1mH	160	mJ
$P_D$	Power Dissipation	$T_C = 25^\circ\text{C}$	104	W
		$T_A = 25^\circ\text{C}$	2.0	W
$T_J, T_{STG}$	Operating and Storage Temperature Range	-55 to +150	$^\circ\text{C}$	

### Thermal Resistance Characteristics

Symbol	Parameter	Typ.	Max.	Units
$R_{\theta JC}$	Junction-to-Case	--	1.2	$^\circ\text{C}/\text{W}$
$R_{\theta JA}$	Junction-to-Ambient (steady state)	--	62	$^\circ\text{C}/\text{W}$

**Electrical Characteristics**  $T_J=25\text{ }^\circ\text{C}$  unless otherwise specified

Symbol	Parameter	Test Conditions	Min	Typ	Max	Units
--------	-----------	-----------------	-----	-----	-----	-------

**On Characteristics**

$V_{GS}$	Gate Threshold Voltage	$V_{DS} = V_{GS}, I_D = 250\ \mu\text{A}$	1.0	--	3.0	V
$R_{DS(ON)}$	Static Drain-Source On-Resistance	$V_{GS} = 10\ \text{V}, I_D = 20\ \text{A}$	--	3.6	4.3	m $\Omega$
		$V_{GS} = 4.5\ \text{V}, I_D = 20\ \text{A}$	--	4.6	6.0	m $\Omega$
$g_{FS}$	Forward Transconductance	$V_{DS} = 5\ \text{V}, I_D = 20\ \text{A}$	--	58	--	S

**Off Characteristics**

$BV_{DSS}$	Drain-Source Breakdown Voltage	$V_{GS} = 0\ \text{V}, I_D = 250\ \mu\text{A}$	60	--	--	V
$I_{DSS}$	Zero Gate Voltage Drain Current	$V_{DS} = 60\ \text{V}, V_{GS} = 0\ \text{V}$	--	--	1	$\mu\text{A}$
		$V_{DS} = 60\ \text{V}, T_J = 100\text{ }^\circ\text{C}$	--	--	100	$\mu\text{A}$
$I_{GSS}$	Gate-Body Leakage Current	$V_{GS} = \pm 20\ \text{V}, V_{DS} = 0\ \text{V}$	--	--	$\pm 100$	nA

**Dynamic Characteristics**

$C_{iss}$	Input Capacitance	$V_{DS} = 30\ \text{V}, V_{GS} = 0\ \text{V},$ $f = 1.0\ \text{MHz}$	--	3250	--	pF
$C_{oss}$	Output Capacitance		--	1200	--	pF
$C_{rss}$	Reverse Transfer Capacitance		--	50	--	pF
$R_g$	Gate Resistance	$V_{GS} = 0\ \text{V}, V_{DS} = 0\ \text{V}, f = 1\ \text{MHz}$	--	1.6	--	$\Omega$

**Switching Characteristics**

$t_{d(on)}$	Turn-On Time	$V_{DS} = 30\ \text{V}, I_D = 20\ \text{A},$ $R_G = 10\ \Omega$	--	12	--	ns
$t_r$	Turn-On Rise Time		--	10	--	ns
$t_{d(off)}$	Turn-Off Delay Time		--	55	--	ns
$t_f$	Turn-Off Fall Time		--	15	--	ns
$Q_{g(10V)}$	Total Gate Charge	$V_{DS} = 30\ \text{V}, I_D = 20\ \text{A},$ $V_{GS} = 10\ \text{V}$	--	49	--	nC
$Q_{g(4.5V)}$	Total Gate Charge		--	24	--	nC
$Q_{gs}$	Gate-Source Charge		--	8	--	nC
$Q_{gd}$	Gate-Drain Charge		--	9	--	nC

**Source-Drain Diode Maximum Ratings and Characteristics**

$I_S$	Continuous Source-Drain Diode Forward Current	--	--	120	A	
$I_{SM}$	Pulsed Source-Drain Diode Forward Current	--	--	350		
$V_{SD}$	Source-Drain Diode Forward Voltage	$I_S = 20\ \text{A}, V_{GS} = 0\ \text{V}$	--	0.9	1.2	V
$t_{rr}$	Reverse Recovery Time	$I_S = 20\ \text{A}, V_R = 30\ \text{V}$	--	50	--	ns
$Q_{rr}$	Reverse Recovery Charge	$di_F/dt = 300\ \text{A}/\mu\text{s}$	--	120	--	nC

# Typical Characteristics

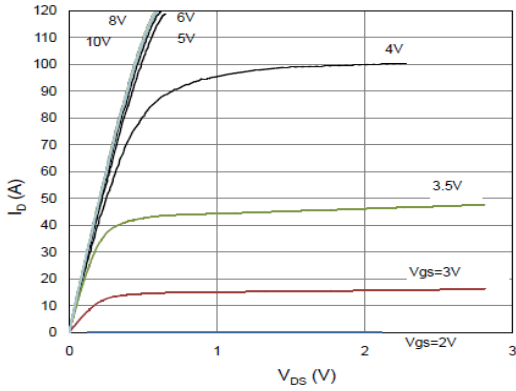

Figure 1. On Region Characteristics

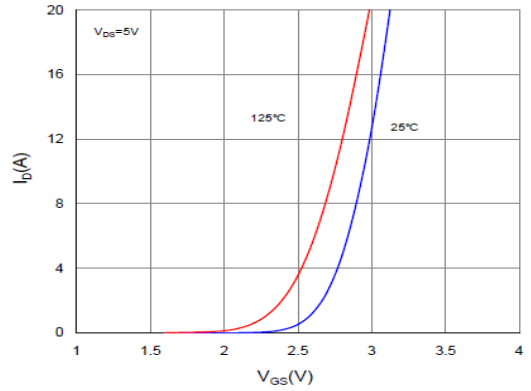

Figure 2. Transfer Characteristics

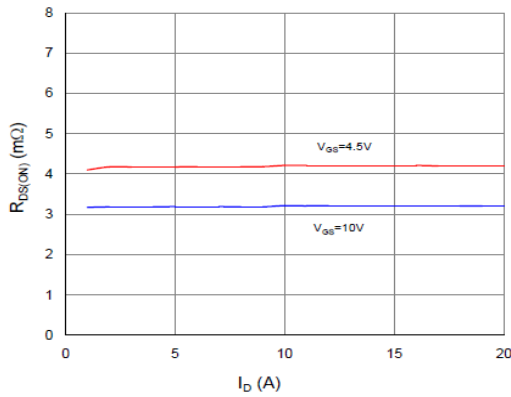

Figure 3. On Resistance Variation vs Drain Current and Gate Voltage

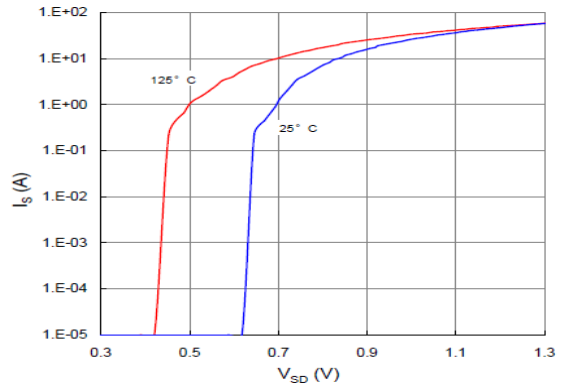

Figure 4. Body Diode Forward Voltage Variation with Source Current and Temperature

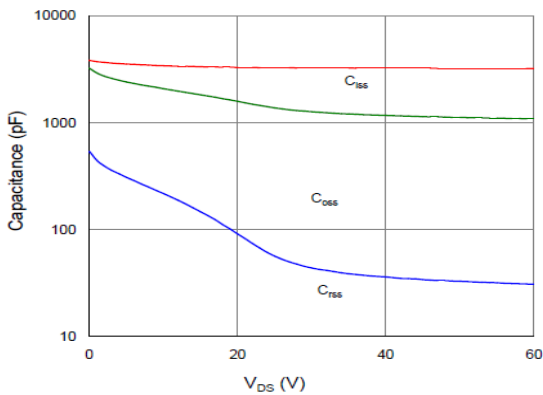

Figure 5. Capacitance Characteristics

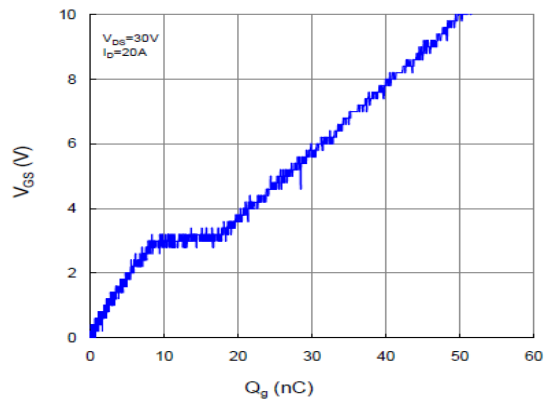
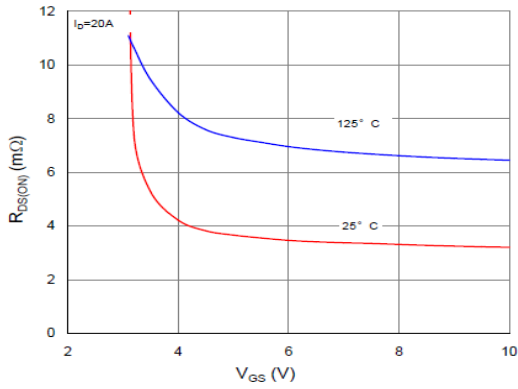
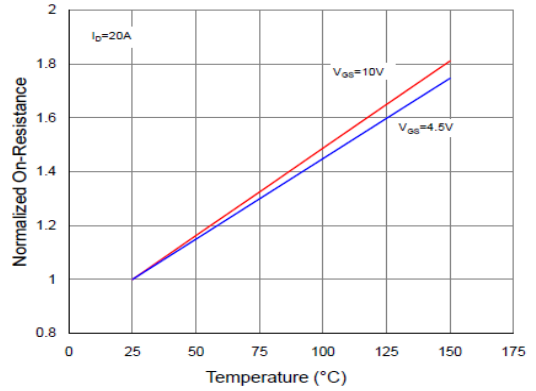

Figure 6. Gate Charge Characteristics

**Typical Characteristics (continued)**



**Figure 7. On-Resistance Variation vs Gate-Source Voltage**



**Figure 8. On-Resistance Variation vs Temperature**

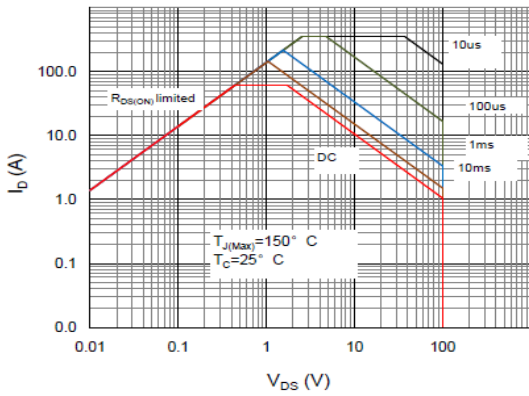

**Figure 9. Maximum Safe Operating Area**

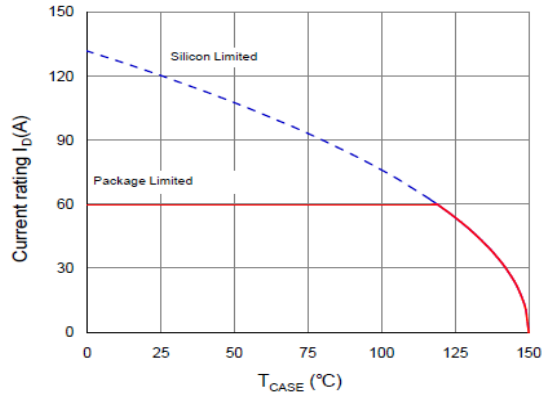

**Figure 10. Maximum Drain Current vs Case Temperature**

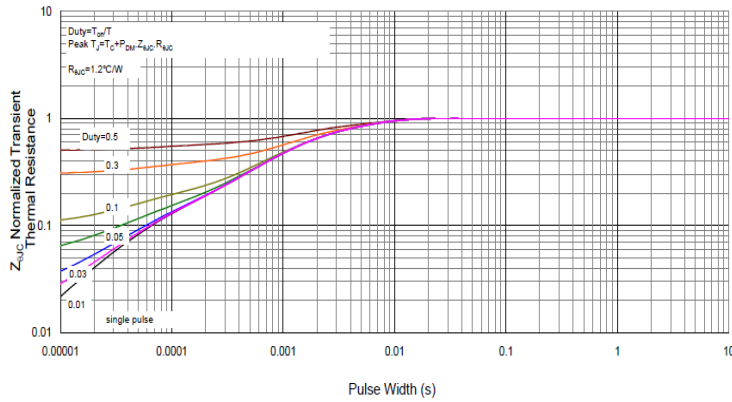

**Figure 11. Transient Thermal Response Curve**

Fig 12. Gate Charge Test Circuit & Waveform

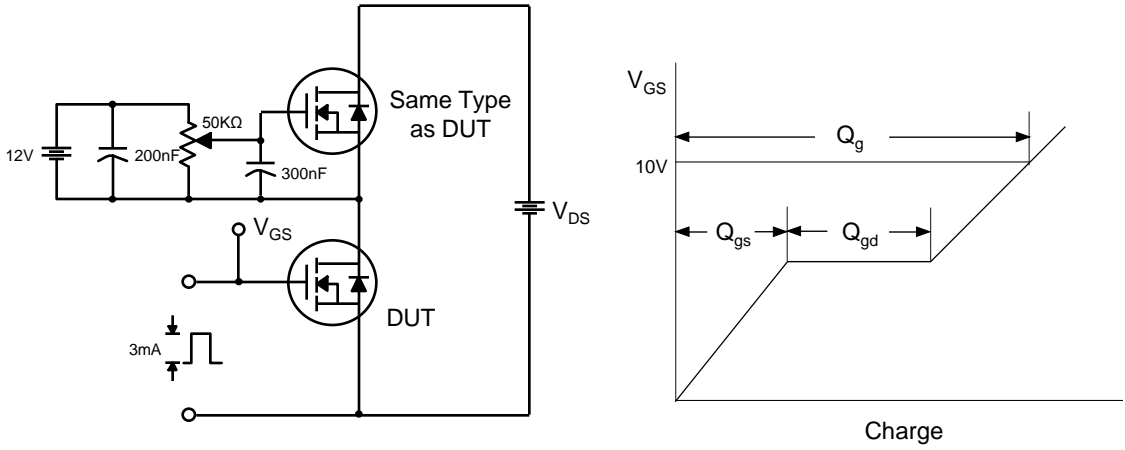

Fig 13. Resistive Switching Test Circuit & Waveforms

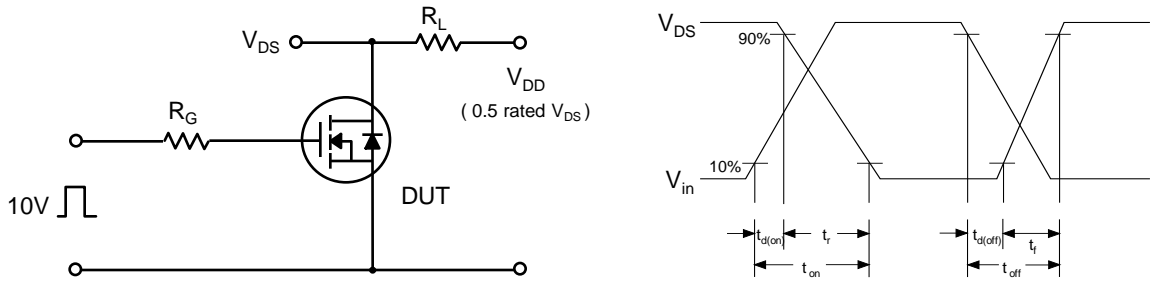

Fig 14. Unclamped Inductive Switching Test Circuit & Waveforms

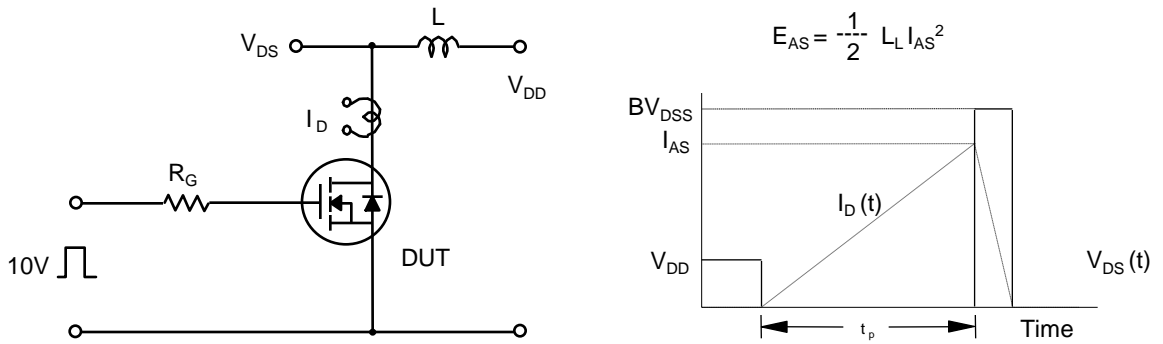
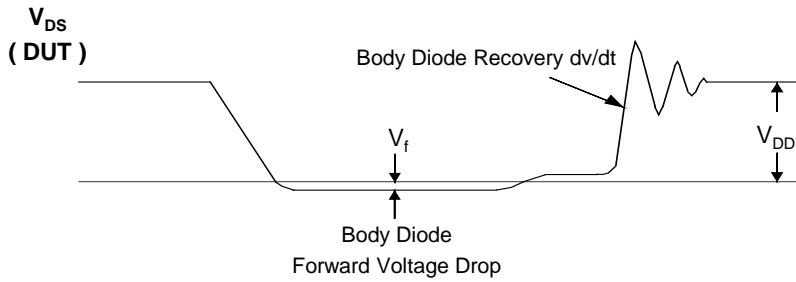
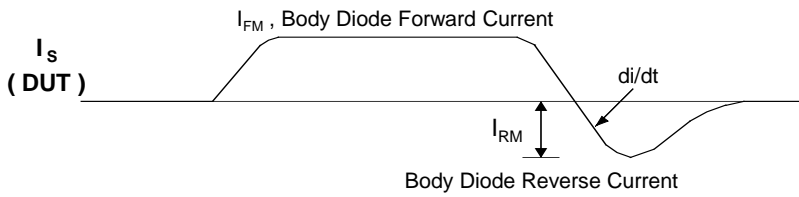
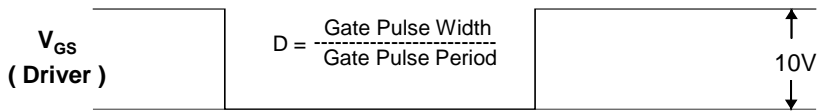
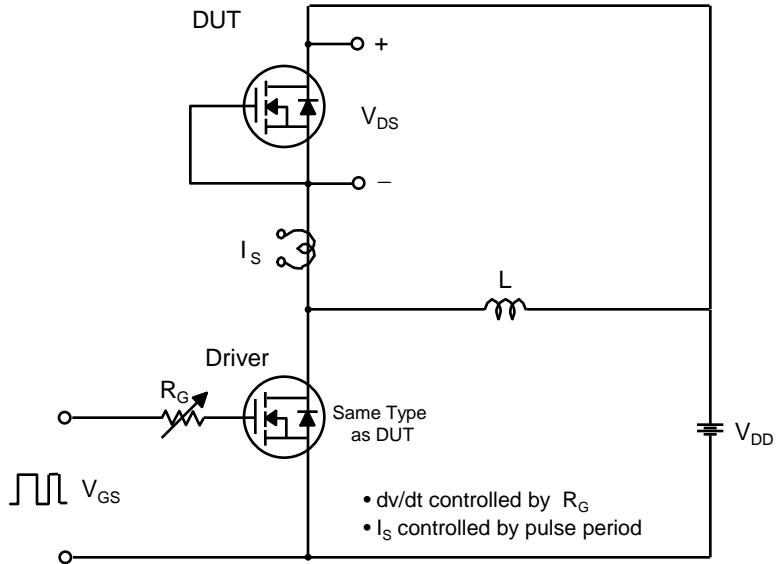
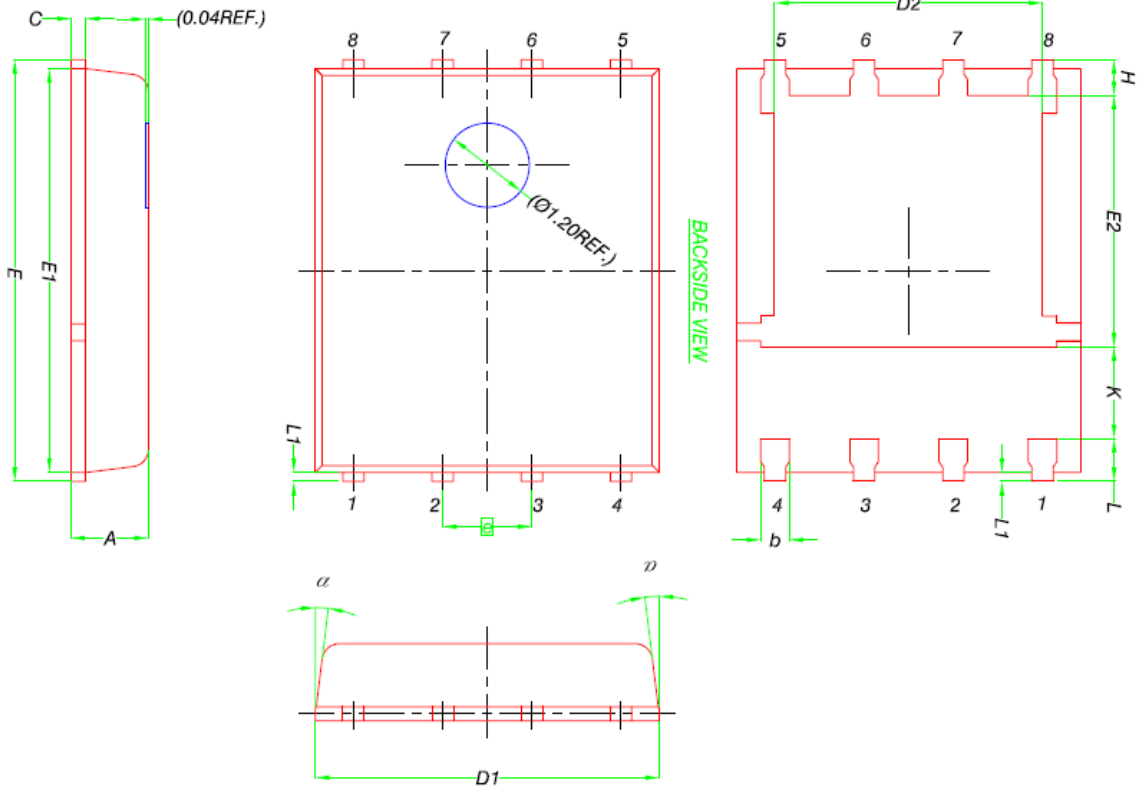

Fig 15. Peak Diode Recovery dv/dt Test Circuit & Waveforms



Package Dimension

8DFN 5x6



DIM.	MILLIMETERS		
	MIN.	NOM.	MAX.
A	0.90	1.00	1.10
b	0.33	0.41	0.51
C	0.20	0.25	0.30
D1	4.80	4.90	5.00
D2	3.61	3.81	3.96
E	5.90	6.00	6.10
E1	5.70	5.75	5.80
E2	3.38	3.58	3.78
$\square$ e	1.27 BSC		
H	0.41	0.51	0.61
K	1.10	-	-
L	0.51	0.61	0.71
L1	0.06	0.13	0.20
$\alpha$	0°	-	12°

