

# HRP35N04K

## 40V N-Channel Trench MOSFET

### FEATURES

- Originative New Design
- Superior Avalanche Rugged Technology
- Excellent Switching Characteristics
- Unrivalled Gate Charge : 110 nC (Typ.)
- Extended Safe Operating Area
- Lower  $R_{DS(ON)}$  : 2.9 mΩ (Typ.) @  $V_{GS}=10V$
- 100% Avalanche Tested

$$BV_{DSS} = 40 V$$

$$R_{DS(on) typ} = 2.9m\Omega$$

$$I_D = 150 A$$

TO-220



1.Gate 2. Drain 3. Source

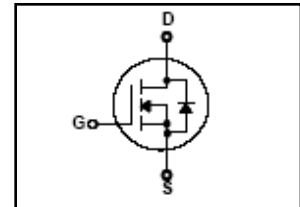

### Absolute Maximum Ratings $T_C=25^\circ C$ unless otherwise specified

Symbol	Parameter	Value	Units
$V_{DSS}$	Drain-Source Voltage	40	V
$I_D$	Drain Current – Continuous ( $T_C = 25^\circ C$ )	150	A
	Drain Current – Continuous ( $T_C = 100^\circ C$ )	105	A
$I_{DM}$	Drain Current – Pulsed (Note 1)	525	A
$V_{GS}$	Gate-Source Voltage	$\pm 20$	V
$E_{AS}$	Single Pulsed Avalanche Energy (Note 2)	3600	mJ
$E_{AR}$	Repetitive Avalanche Energy (Note 1)	13.6	mJ
$P_D$	Power Dissipation ( $T_C = 25^\circ C$ ) - Derate above $25^\circ C$	136	W
		0.9	W/ $^\circ C$
$T_J, T_{STG}$	Operating and Storage Temperature Range	-55 to +175	$^\circ C$
$T_L$	Maximum lead temperature for soldering purposes, 1/8" from case for 5 seconds	300	$^\circ C$

### Thermal Resistance Characteristics

Symbol	Parameter	Typ.	Max.	Units
$R_{\theta JC}$	Junction-to-Case	--	1.1	$^\circ C/W$
$R_{\theta CS}$	Case-to-Sink	0.5	--	
$R_{\theta JA}$	Junction-to-Ambient	--	62.5	

**Electrical Characteristics**  $T_J=25^\circ\text{C}$  unless otherwise specified

Symbol	Parameter	Test Conditions	Min	Typ	Max	Units
<b>On Characteristics</b>						
$V_{GS}$	Gate Threshold Voltage	$V_{DS} = V_{GS}, I_D = 250 \mu\text{A}$	2.0	--	3.6	V
$R_{DS(ON)}$	Static Drain-Source On-Resistance	$V_{GS} = 10 \text{ V}, I_D = 40 \text{ A}$	--	2.9	3.5	m $\Omega$
$g_{FS}$	Forward Transconductance	$V_{DS} = 20, I_D = 40 \text{ A}$	--	80	--	S
<b>Off Characteristics</b>						
$BV_{DSS}$	Drain-Source Breakdown Voltage	$V_{GS} = 0 \text{ V}, I_D = 250 \mu\text{A}$	40	--	--	V
$I_{DSS}$	Zero Gate Voltage Drain Current	$V_{DS} = 32 \text{ V}, V_{GS} = 0 \text{ V}$	--	--	1	$\mu\text{A}$
		$V_{DS} = 32 \text{ V}, T_J = 125^\circ\text{C}$	--	--	100	$\mu\text{A}$
$I_{GSS}$	Gate-Body Leakage Current	$V_{GS} = \pm 20 \text{ V}, V_{DS} = 0 \text{ V}$	--	--	$\pm 100$	nA
<b>Dynamic Characteristics</b>						
$C_{iss}$	Input Capacitance	$V_{DS} = 25 \text{ V}, V_{GS} = 0 \text{ V},$ $f = 1.0 \text{ MHz}$	--	4600	--	pF
$C_{oss}$	Output Capacitance		--	1000	--	pF
$C_{riss}$	Reverse Transfer Capacitance		--	700	--	pF
$R_g$	Gate Resistance	$V_{GS} = 0 \text{ V}, V_{DS} = 0 \text{ V}, f = 1\text{MHz}$	--	1.7	--	$\Omega$
<b>Switching Characteristics</b>						
$t_{d(on)}$	Turn-On Time	$V_{DS} = 20 \text{ V}, I_D = 30 \text{ A},$ $R_G = 6 \Omega$	--	70	--	ns
$t_r$	Turn-On Rise Time		--	110	--	ns
$t_{d(off)}$	Turn-Off Delay Time		--	150	--	ns
$t_f$	Turn-Off Fall Time		--	90	--	ns
$Q_g$	Total Gate Charge	$V_{DS} = 32 \text{ V}, I_D = 30 \text{ A},$ $V_{GS} = 10 \text{ V}$	--	110	--	nC
$Q_{gs}$	Gate-Source Charge		--	20	--	nC
$Q_{gd}$	Gate-Drain Charge		--	45	--	nC
<b>Source-Drain Diode Maximum Ratings and Characteristics</b>						
$I_S$	Continuous Source-Drain Diode Forward Current		--	--	150	A
$I_{SM}$	Pulsed Source-Drain Diode Forward Current		--	--	525	
$V_{SD}$	Source-Drain Diode Forward Voltage	$I_S = 30 \text{ A}, V_{GS} = 0 \text{ V}$	--	--	1.3	V
$t_{rr}$	Reverse Recovery Time	$I_S = 25 \text{ A}, V_{GS} = 0 \text{ V}$ $di_F/dt = 50 \text{ A}/\mu\text{s}$	--	90	--	ns
$Q_{rr}$	Reverse Recovery Charge		--	50	--	nC

**Notes :**

1. Repetitive Rating : Pulse width limited by maximum junction temperature
2.  $L=1\text{mH}, I_{AS}=30\text{A}, V_{DD}=35\text{V}, R_G=25\Omega,$  Starting  $T_J=25^\circ\text{C}$

# Typical Characteristics

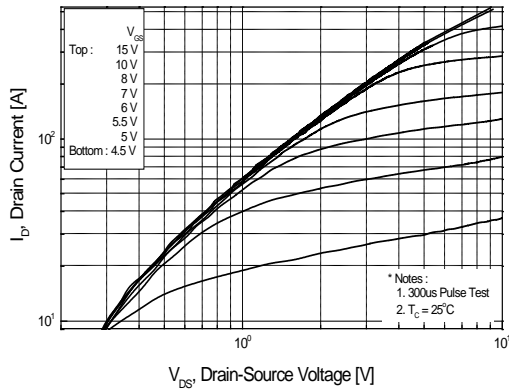

Figure 1. On Region Characteristics

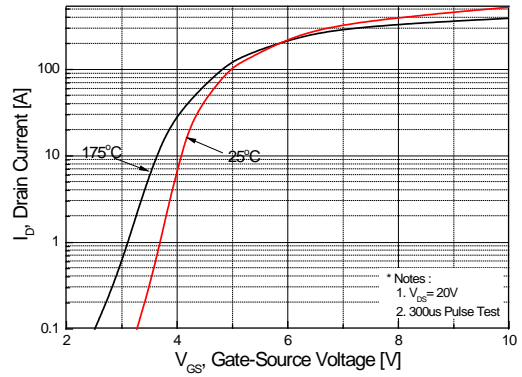

Figure 2. Transfer Characteristics

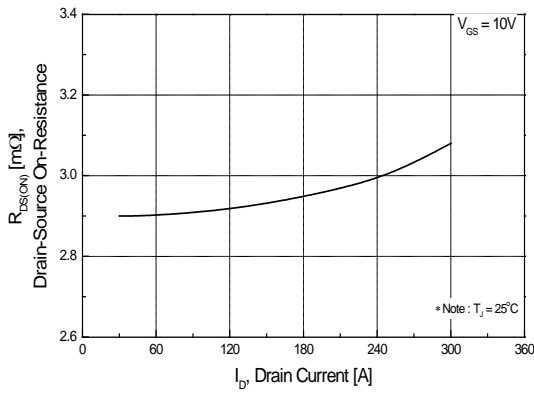

Figure 3. On Resistance Variation vs Drain Current and Gate Voltage

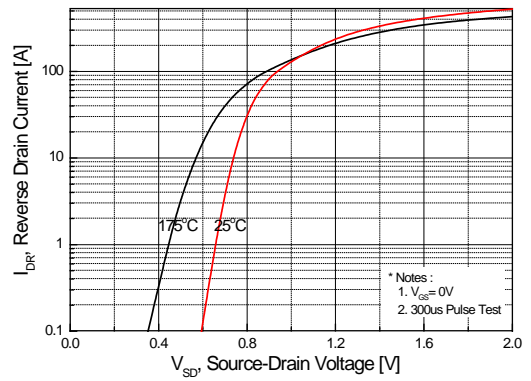

Figure 4. Body Diode Forward Voltage Variation with Source Current and Temperature

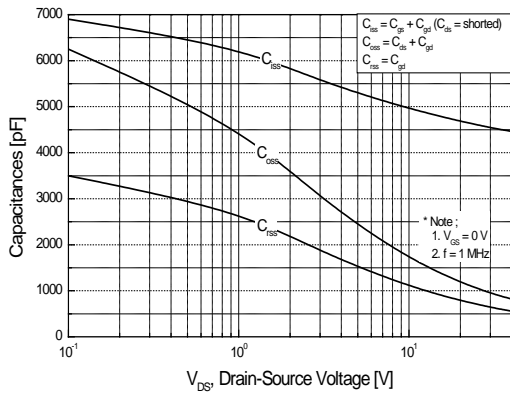

Figure 5. Capacitance Characteristics

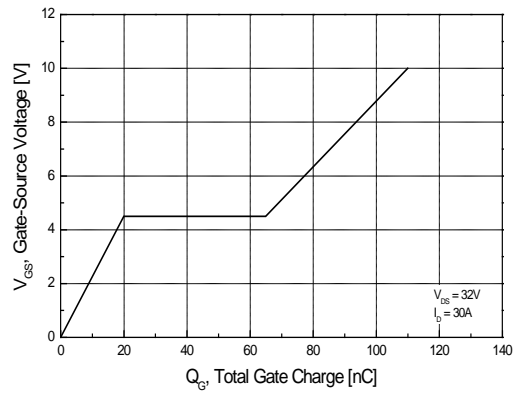

Figure 6. Gate Charge Characteristics

Typical Characteristics (continued)

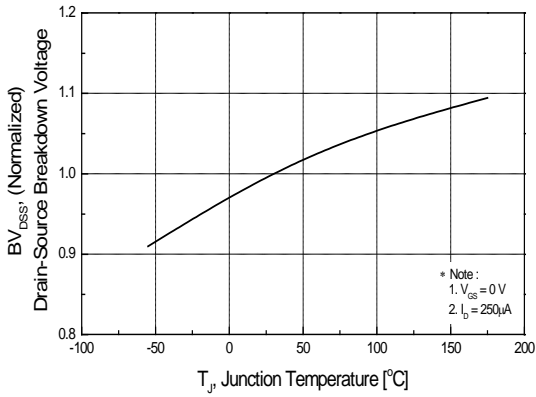

Figure 7. Breakdown Voltage Variation vs Temperature

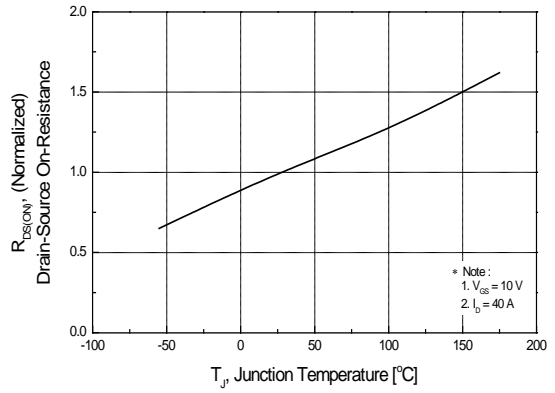

Figure 8. On-Resistance Variation vs Temperature

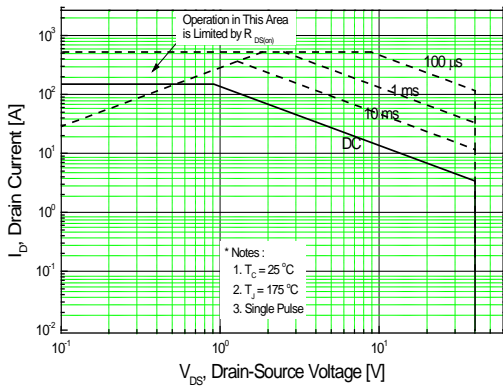

Figure 9. Maximum Safe Operating Area

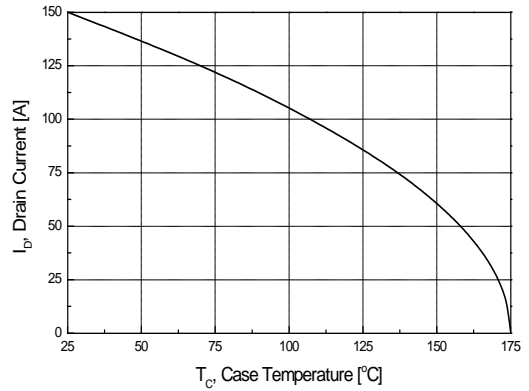

Figure 10. Maximum Drain Current vs Case Temperature

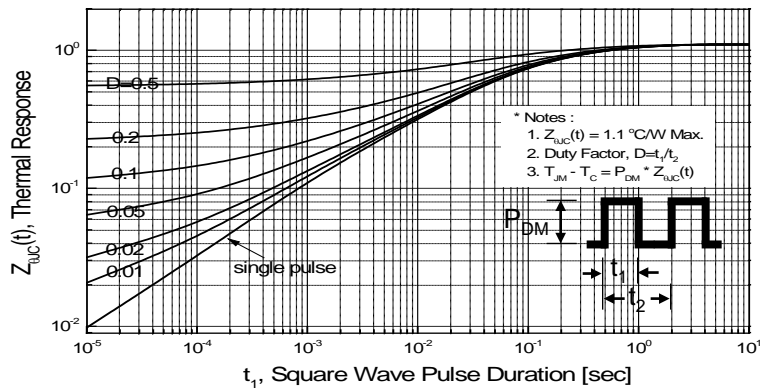

Figure 11. Transient Thermal Response Curve

Fig 12. Gate Charge Test Circuit & Waveform

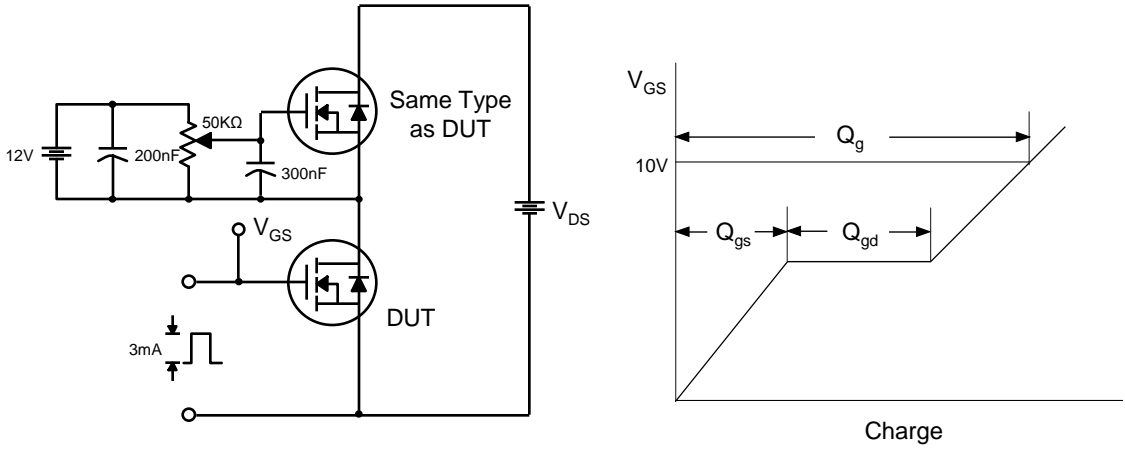

Fig 13. Resistive Switching Test Circuit & Waveforms

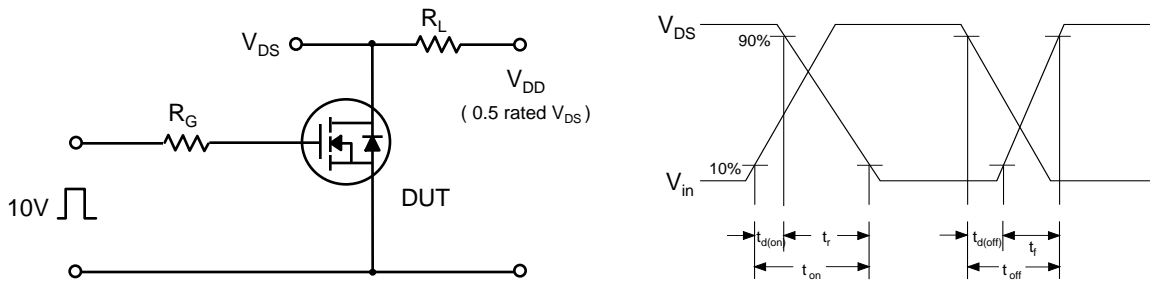

Fig 14. Unclamped Inductive Switching Test Circuit & Waveforms

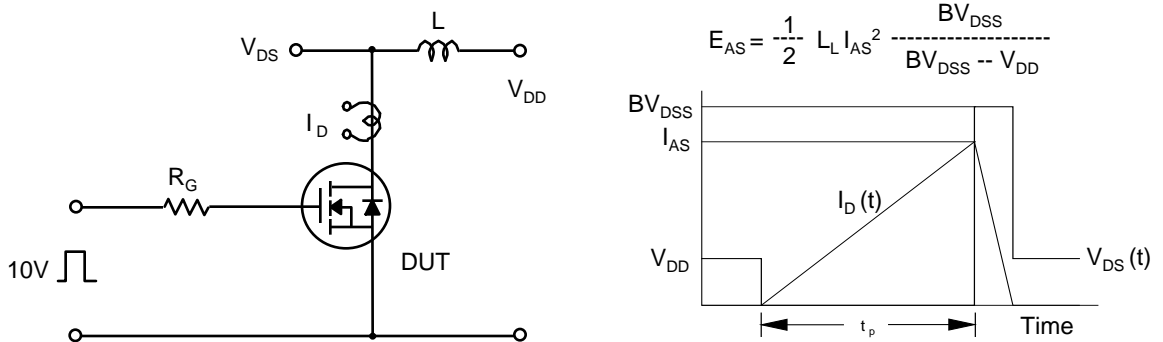
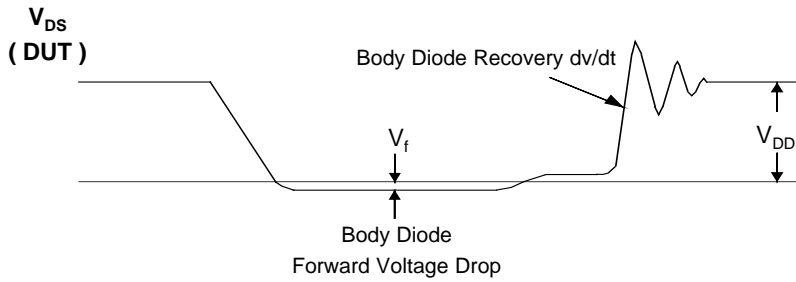
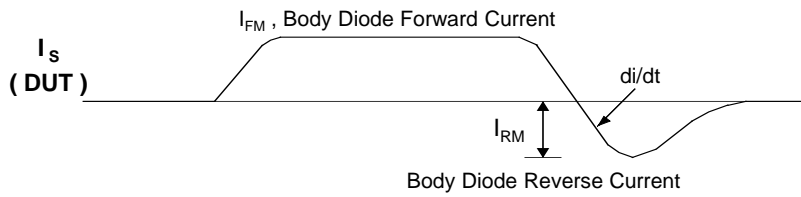
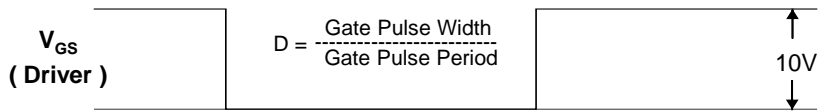
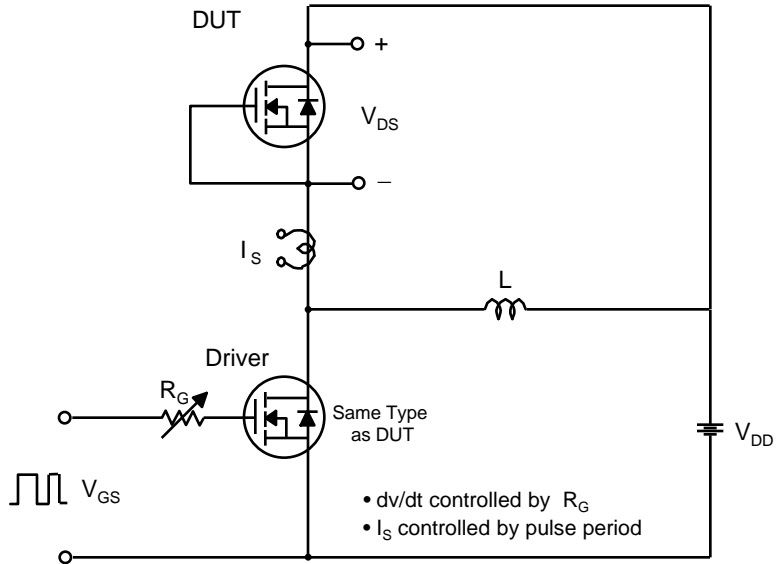

Fig 15. Peak Diode Recovery dv/dt Test Circuit & Waveforms



Package Dimension

TO-220 (A)



Package Dimension

TO-220 (B)

