

# HRS75N75V

## 70V N-Channel Trench MOSFET

$BV_{DSS} = 70\text{ V}$   
 $R_{DS(on) \text{ typ}} = 6\text{ m}\Omega$   
 $I_D = 48\text{ A}$

### FEATURES

- Originative New Design
- Superior Avalanche Rugged Technology
- Excellent Switching Characteristics
- Unrivalled Gate Charge : 80 nC (Typ.)
- Extended Safe Operating Area
- Lower  $R_{DS(ON)}$  : 6.0 m $\Omega$  (Typ.) @  $V_{GS}=10\text{V}$
- 100% Avalanche Tested

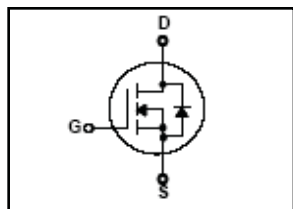

### Absolute Maximum Ratings $T_C=25^\circ\text{C}$ unless otherwise specified

Symbol	Parameter	Value	Units
$V_{DSS}$	Drain-Source Voltage	70	V
$I_D$	Drain Current – Continuous ( $T_C = 25^\circ\text{C}$ )	48*	A
	Drain Current – Continuous ( $T_C = 100^\circ\text{C}$ )	30*	A
$I_{DM}$	Drain Current – Pulsed (Note 1)	192*	A
$V_{GS}$	Gate-Source Voltage	$\pm 25$	V
$E_{AS}$	Single Pulsed Avalanche Energy (Note 2)	810	mJ
$I_{AR}$	Avalanche Current (Note 1)	48	A
$E_{AR}$	Repetitive Avalanche Energy (Note 1)	4.8	mJ
dv/dt	Peak Diode Recovery dv/dt	15	V/ns
$P_D$	Power Dissipation ( $T_C = 25^\circ\text{C}$ ) - Derate above $25^\circ\text{C}$	38	W
		0.3	W/ $^\circ\text{C}$
$T_J, T_{STG}$	Operating and Storage Temperature Range	-55 to +150	$^\circ\text{C}$
$T_L$	Maximum lead temperature for soldering purposes, 1/8" from case for 5 seconds	300	$^\circ\text{C}$

\* Drain current limited by maximum junction temperature

### Thermal Resistance Characteristics

Symbol	Parameter	Typ.	Max.	Units
$R_{\theta JC}$	Junction-to-Case	--	3.3	$^\circ\text{C}/\text{W}$
$R_{\theta JA}$	Junction-to-Ambient	--	62.5	

## Package Marking and Odering Information

Device Marking	Week Marking	Package	Packing	Quantity	RoHS Status
HRS75N75V	YWWX	TO-220F	Tube	50	Pb Free
HRS75N75V	YWWXg	TO-220F	Tube	50	Halogen Free

## Electrical Characteristics $T_C=25\text{ }^\circ\text{C}$ unless otherwise specified

Symbol	Parameter	Test Conditions	Min	Typ	Max	Units
--------	-----------	-----------------	-----	-----	-----	-------

### On Characteristics

$V_{GS}$	Gate Threshold Voltage	$V_{DS} = V_{GS}, I_D = 250\ \mu\text{A}$	2.0	--	4.0	V
$R_{DS(ON)}$	Static Drain-Source On-Resistance	$V_{GS} = 10\ \text{V}, I_D = 24\ \text{A}$	--	6.0	7.5	m $\Omega$

### Off Characteristics

$BV_{DSS}$	Drain-Source Breakdown Voltage	$V_{GS} = 0\ \text{V}, I_D = 250\ \mu\text{A}$	70	--	--	V
$I_{DSS}$	Zero Gate Voltage Drain Current	$V_{DS} = 70\ \text{V}, V_{GS} = 0\ \text{V}$	--	--	1	$\mu\text{A}$
		$V_{DS} = 56\ \text{V}, T_C = 150\text{ }^\circ\text{C}$	--	--	10	$\mu\text{A}$
$I_{GSS}$	Gate-Body Leakage Current	$V_{GS} = \pm 20\ \text{V}, V_{DS} = 0\ \text{V}$	--	--	$\pm 100$	nA

### Dynamic Characteristics

$C_{iss}$	Input Capacitance	$V_{DS} = 25\ \text{V}, V_{GS} = 0\ \text{V},$ $f = 1.0\ \text{MHz}$	--	4000	5200	pF
$C_{oss}$	Output Capacitance		--	350	455	pF
$C_{rss}$	Reverse Transfer Capacitance		--	250	325	pF

### Switching Characteristics

$t_{d(on)}$	Turn-On Time	$V_{DS} = 35\ \text{V}, I_D = 40\ \text{A},$ $R_G = 25\ \Omega$	--	75	160	ns	
$t_r$	Turn-On Rise Time		--	150	310	ns	
$t_{d(off)}$	Turn-Off Delay Time		(Note 4,5)	--	150	310	ns
$t_f$	Turn-Off Fall Time			--	60	130	ns
$Q_g$	Total Gate Charge	$V_{DS} = 56\ \text{V}, I_D = 40\ \text{A},$ $V_{GS} = 10\ \text{V}$	--	80	105	nC	
$Q_{gs}$	Gate-Source Charge		(Note 3,4)	--	20	--	nC
$Q_{gd}$	Gate-Drain Charge			--	30	--	nC

### Source-Drain Diode Maximum Ratings and Characteristics

$I_S$	Continuous Source-Drain Diode Forward Current	--	--	48	A	
$I_{SM}$	Pulsed Source-Drain Diode Forward Current	--	--	192		
$V_{SD}$	Source-Drain Diode Forward Voltage	$I_S = 48\ \text{A}, V_{GS} = 0\ \text{V}$	--	--	1.2	V
$t_{rr}$	Reverse Recovery Time	$I_S = 48\ \text{A}, V_{GS} = 0\ \text{V}$ $di_f/dt = 100\ \text{A}/\mu\text{s}$ (Note 3)	--	80	--	ns
$Q_{rr}$	Reverse Recovery Charge		--	180	--	nC

#### Notes ;

1. Repetitive Rating : Pulse width limited by maximum junction temperature
2.  $L=450\ \mu\text{H}, I_{AS}=48\ \text{A}, V_{DD}=25\ \text{V}, R_G=25\ \Omega,$  Starting  $T_J=25\text{ }^\circ\text{C}$
3.  $I_{SD}\leq 48\ \text{A}, di/dt\leq 200\ \text{A}/\mu\text{s}, V_{DD}\leq BV_{DSS},$  Starting  $T_J=25\text{ }^\circ\text{C}$
4. Pulse Test : Pulse Width  $\leq 300\ \mu\text{s},$  Duty Cycle  $\leq 2\%$
5. Essentially Independent of Operating Temperature

Typical Characteristics

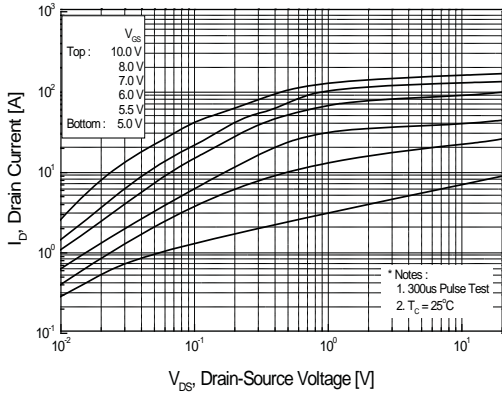

Figure 1. On Region Characteristics

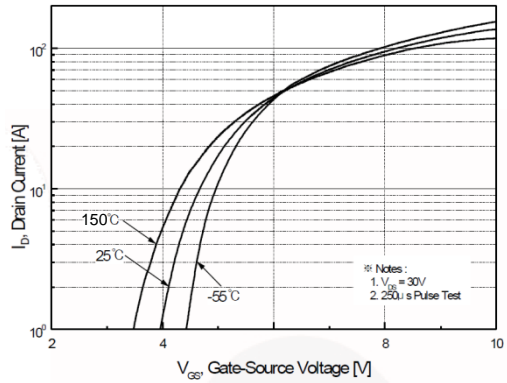

Figure 2. Transfer Characteristics

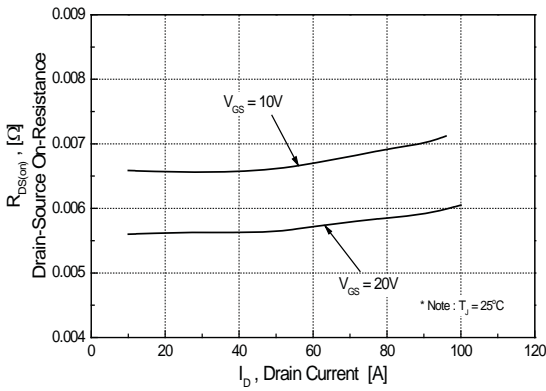

Figure 3. On Resistance Variation vs Drain Current and Gate Voltage

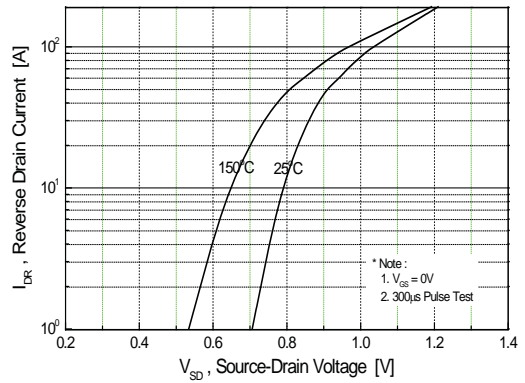

Figure 4. Body Diode Forward Voltage Variation with Source Current and Temperature

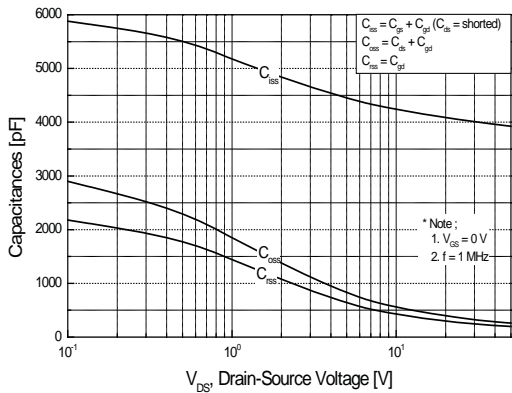

Figure 5. Capacitance Characteristics

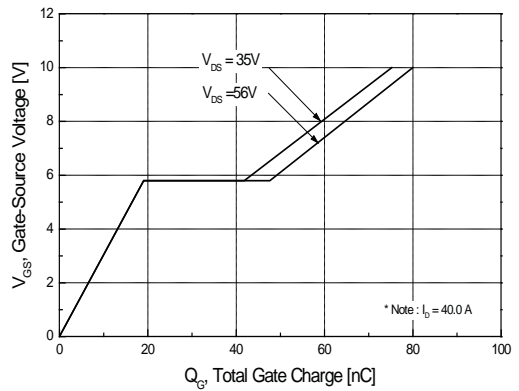

Figure 6. Gate Charge Characteristics

Typical Characteristics

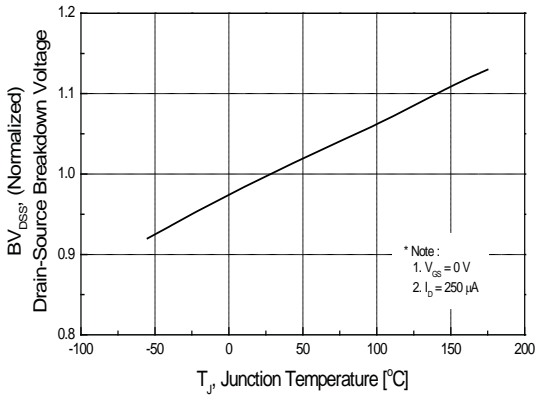

Figure 7. Breakdown Voltage Variation vs Temperature

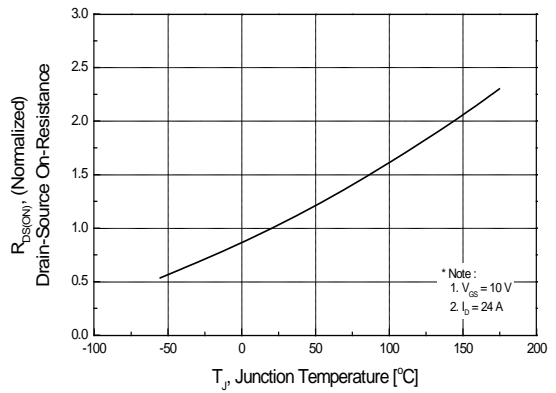

Figure 8. On-Resistance Variation vs Temperature

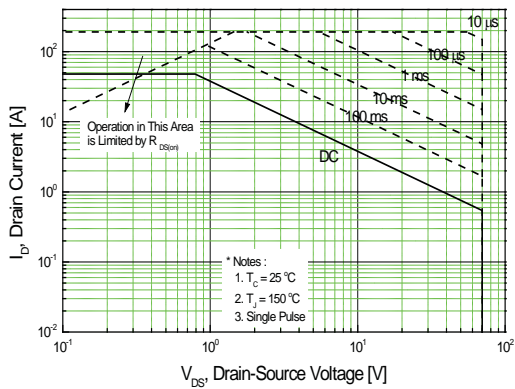

Figure 9. Maximum Safe Operating Area

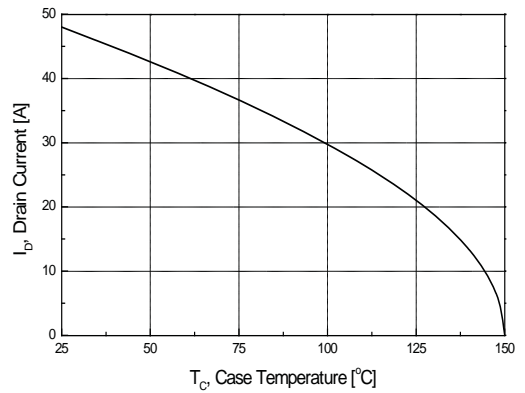

Figure 10. Maximum Drain Current vs Case Temperature

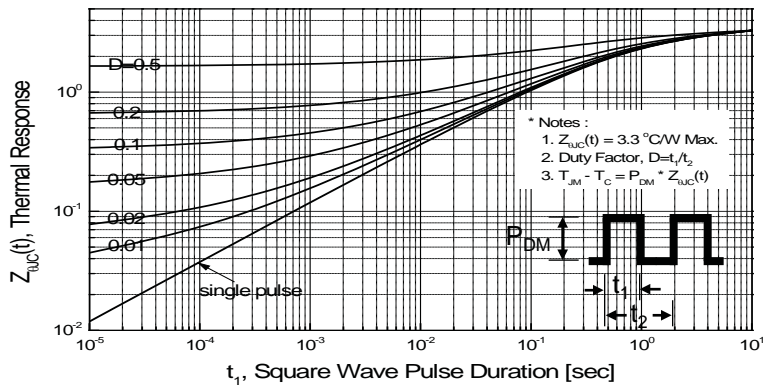

Figure 11. Transient Thermal Response Curve

Fig 12. Gate Charge Test Circuit & Waveform

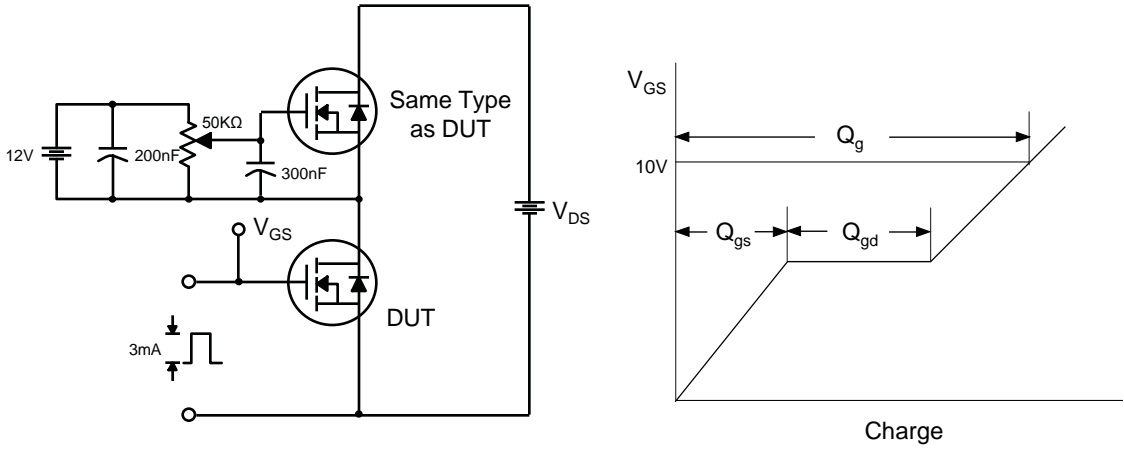

Fig 13. Resistive Switching Test Circuit & Waveforms

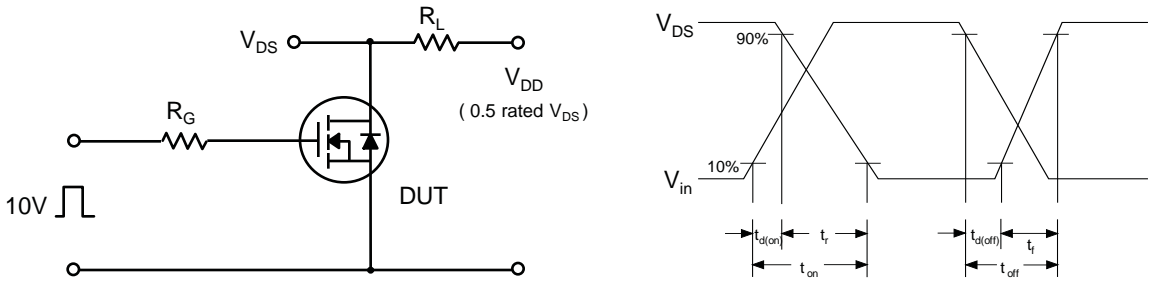

Fig 14. Unclamped Inductive Switching Test Circuit & Waveforms

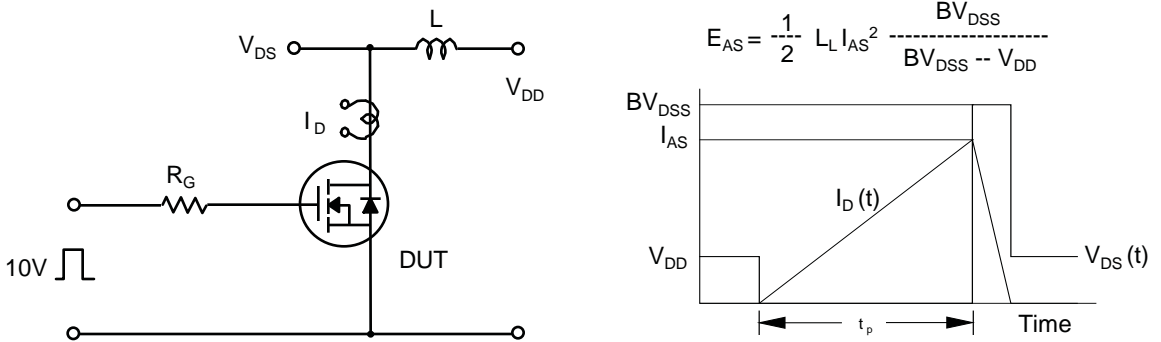
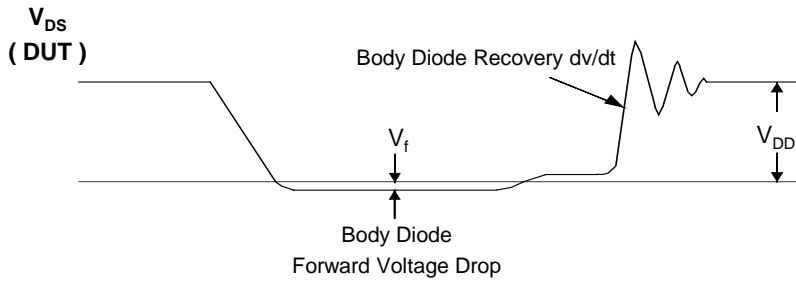
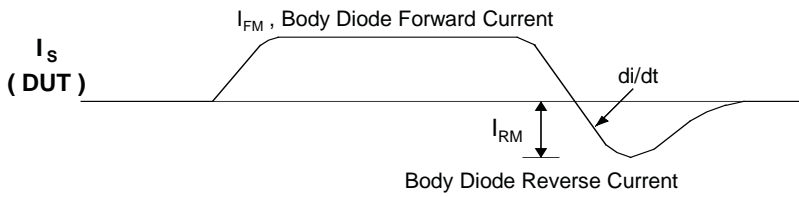
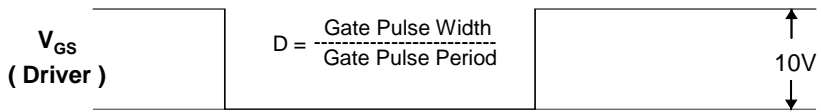
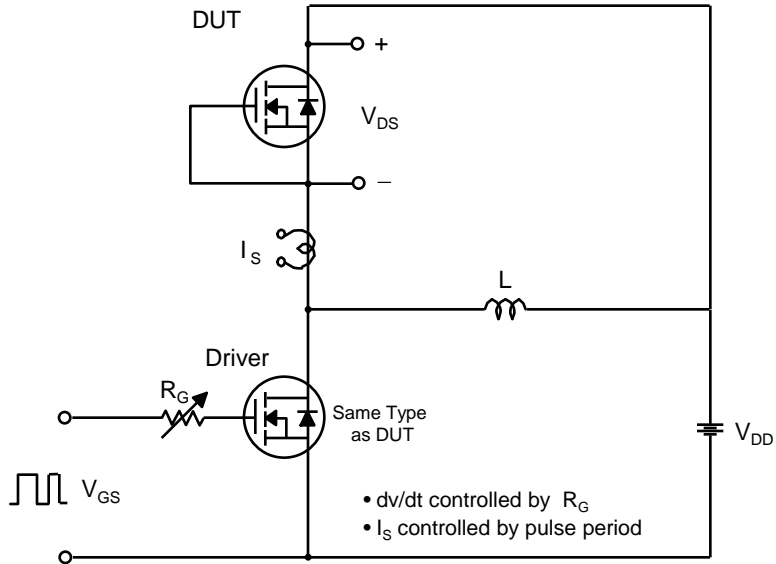

Fig 15. Peak Diode Recovery dv/dt Test Circuit & Waveforms



Package Dimension

TO-220F

