

**Radiation Hardened Uncompensated, High Slew Rate Operational Amplifier**

The HS-2520RH is a radiation hardened monolithic operational amplifier which delivers an unsurpassed combination of specifications for slew rate, bandwidth and settling time. This dielectrically isolated amplifier is designed for closed loop gains of 3 or greater without external compensation. In addition, this high performance component also provides low offset current and high input impedance.

The 100V/μs (Min) slew rate and fast settling time of this amplifier makes it an ideal component for pulse amplification and data acquisition designs. To insure compliance with slew rate and transient response specifications, all devices are 100% tested for AC performance characteristics over full temperature. This device is a valuable component for RF and video circuitry requiring wideband operation. For accurate signal conditioning designs, the HS-2520RH superior dynamic specifications are complemented by 25nA (Max) offset current and offset voltage trim capability.

**Specifications for Rad Hard QML devices are controlled by the Defense Supply Center in Columbus (DSCC). The SMD numbers listed here must be used when ordering.**

Detailed Electrical Specifications for these devices are contained in SMD 5962-95685. A "hot-link" is provided on our homepage for downloading. [www.intersil.com/spacedefense/space.asp](http://www.intersil.com/spacedefense/space.asp)

**Features**

- Electrically Screened to SMD # 5962-95685
- QML Qualified per MIL-PRF-38535 Requirements
- High Slew Rate. . . . . 100V/μs Min, 120V/μs (Typ)
- Wide Power Bandwidth . . . . . 1.5MHz (Min)
- Wide Gain Bandwidth . . . . . 10MHz Min, 20MHz (Typ)
- High Input Impedance . . . . . 50MΩ Min, 100MΩ (Typ)
- Low Offset Current . . . . . 25nA Min, 10nA (Typ)
- Fast Settling (0.1% of 10V Step) . . . . . 200ns (Typ)
- Low Quiescent Supply Current. . . . . 6mA (Max)
- Gamma Dose . . . . . 1 x 10<sup>4</sup>RAD(Si)

**Applications**

- Data Acquisition Systems
- RF Amplifiers
- Video Amplifiers
- Signal Generators
- Pulse Amplifiers

**Ordering Information**

ORDERING NUMBER	INTERNAL MKT. NUMBER	TEMP. RANGE (°C)
HS0-2520RH-Q	HS0-2520RH-Q	25
5962D9568501VGA	HS2-2520RH-Q	-55 to 125
5962D9568501VPA	HS7-2520RH-Q	-55 to 125
5962D9568501VPC	HS7B-2520RH-Q	-55 to 125

**Pinouts**

HS7-2520RH (CERDIP) GDIP1-T8  
OR  
HS7B-2520RH (SBDIP) CDIP2-T8  
TOP VIEW

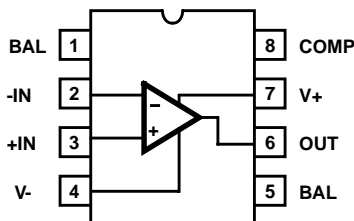

HS2-2520RH (CAN) MACY1-X8  
TOP VIEW

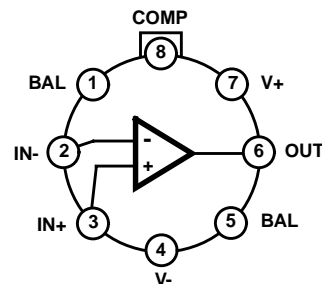

Timing Waveforms

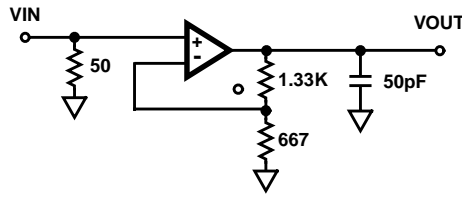

FIGURE 1. SIMPLIFIED TEST CIRCUIT

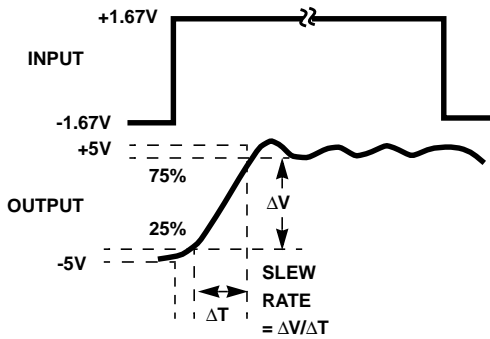

FIGURE 2. SLEW RATE WAVEFORM

NOTE: Measured on both positive and negative transitions. Capacitance at Compensation pin should be minimized.

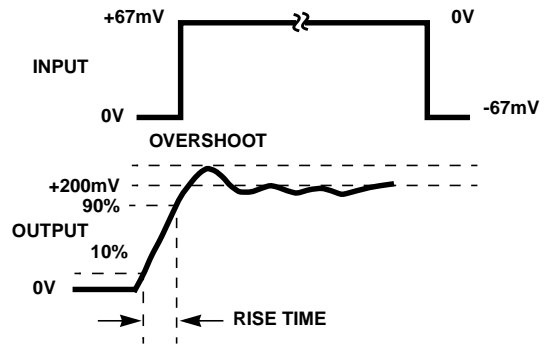

FIGURE 3. TRANSIENT RESPONSE WAVEFORM

Typical Performance Curves  $T_A = 25^\circ\text{C}$ ,  $V_{\text{SUPPLY}} = \pm 15\text{V}$ , Unless Otherwise Specified

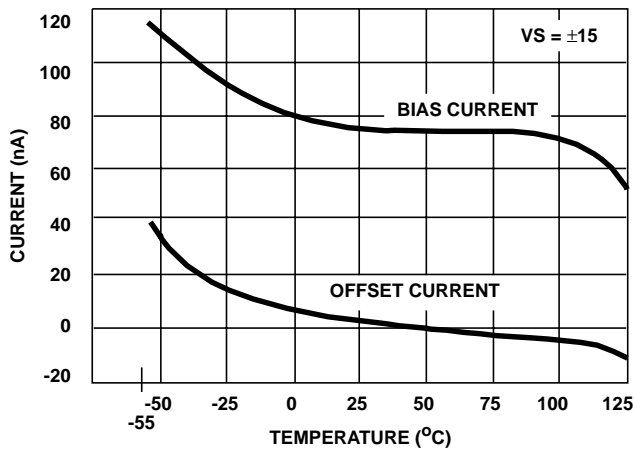

FIGURE 4. INPUT BIAS AND OFFSET CURRENT vs TEMPERATURE

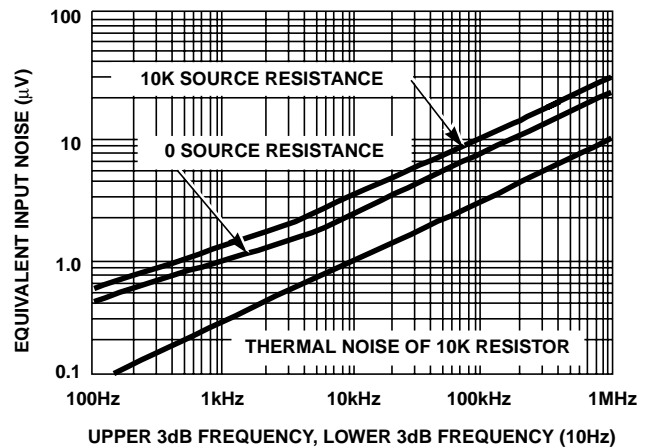

FIGURE 5. EQUIVALENT INPUT NOISE vs BANDWIDTH

Typical Performance Curves  $T_A = 25^\circ\text{C}$ ,  $V_{\text{SUPPLY}} = \pm 15\text{V}$ , Unless Otherwise Specified (Continued)

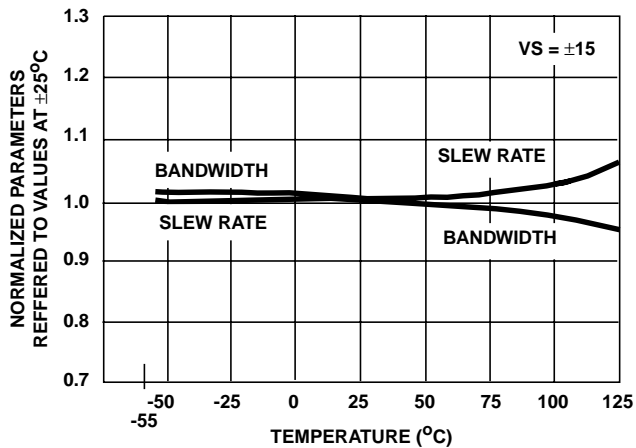

FIGURE 6. NORMALIZED AC PARAMETERS vs TEMPERATURE

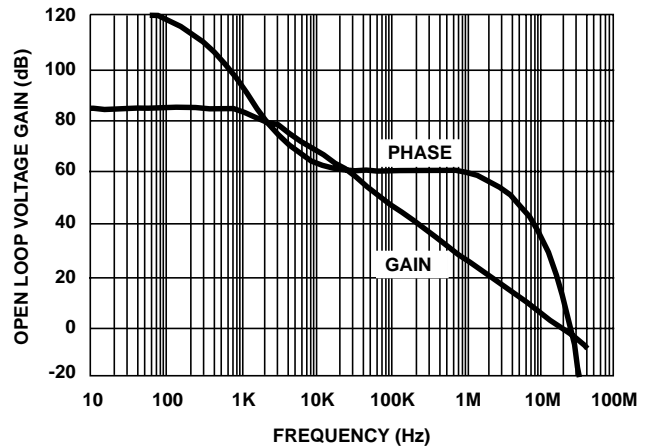

FIGURE 7. OPEN-LOOP FREQUENCY AND PHASE RESPONSE

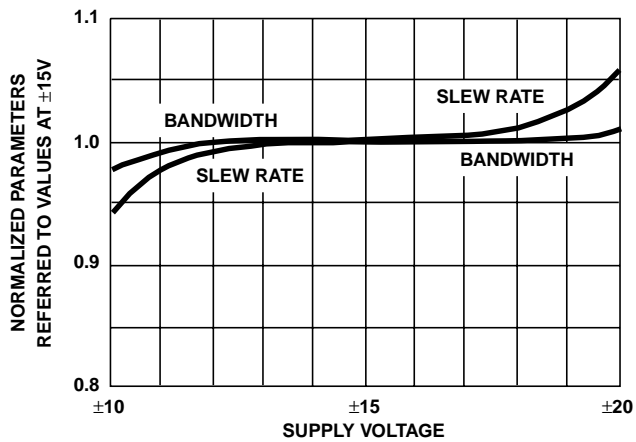

FIGURE 8. NORMALIZED AC PARAMETERS vs SUPPLY VOLTAGE AT  $25^\circ\text{C}$

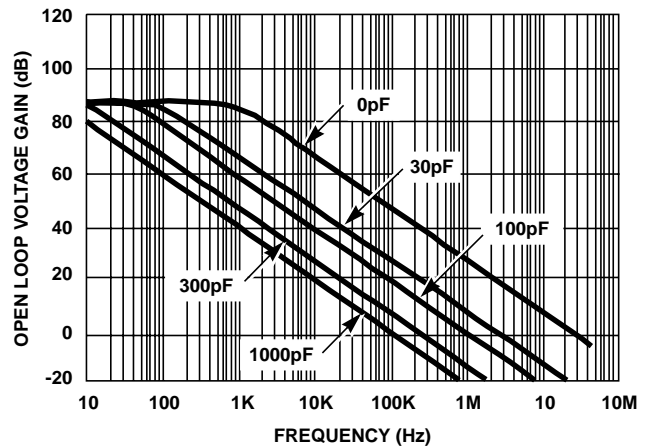

FIGURE 9. OPEN-LOOP FREQUENCY RESPONSE FOR VARIOUS VALUES OF CAPACITORS FROM BANDWIDTH CONTROL PIN TO GROUND

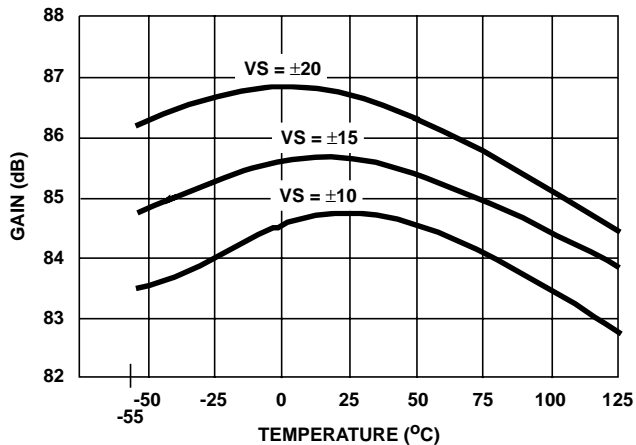

FIGURE 10. OPEN-LOOP VOLTAGE GAIN vs TEMPERATURE

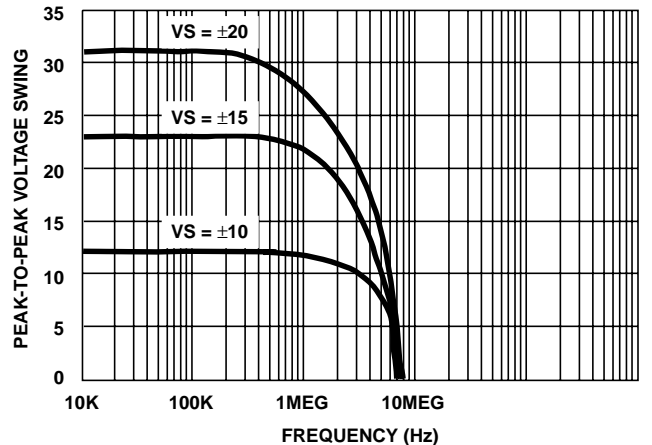

FIGURE 11. OUTPUT VOLTAGE SWING vs FREQUENCY AT  $25^\circ\text{C}$

**Typical Performance Curves**  $T_A = 25^\circ\text{C}$ ,  $V_{\text{SUPPLY}} = \pm 15\text{V}$ , Unless Otherwise Specified (Continued)

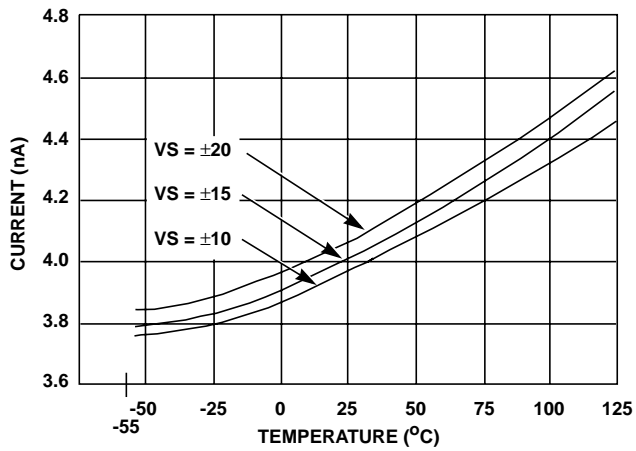

FIGURE 12. POWER SUPPLY CURRENT vs TEMPERATURE

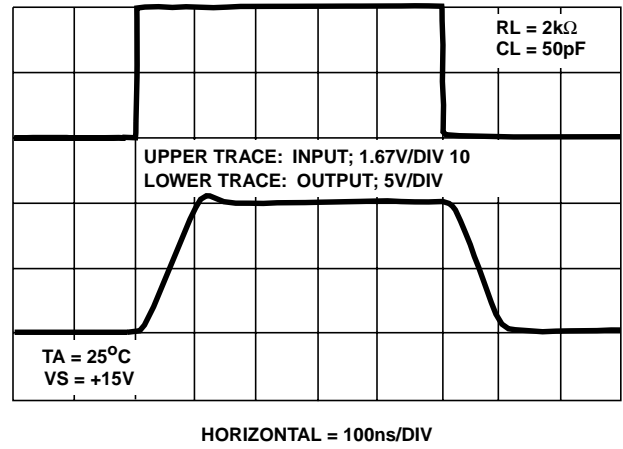

FIGURE 13. VOLTAGE FOLLOWER PULSE RESPONSE

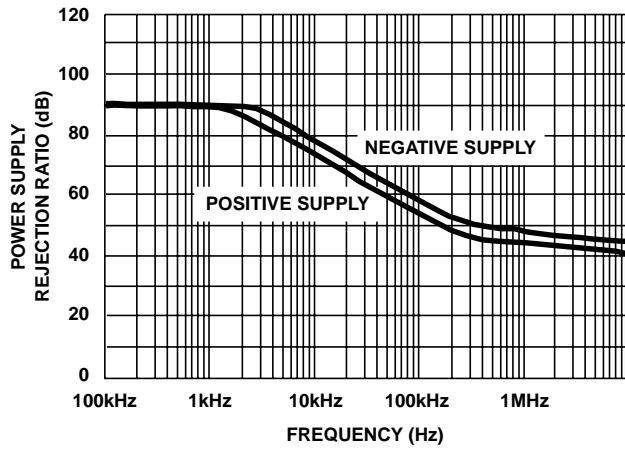

FIGURE 14. POWER SUPPLY REJECTION RATIO vs FREQUENCY

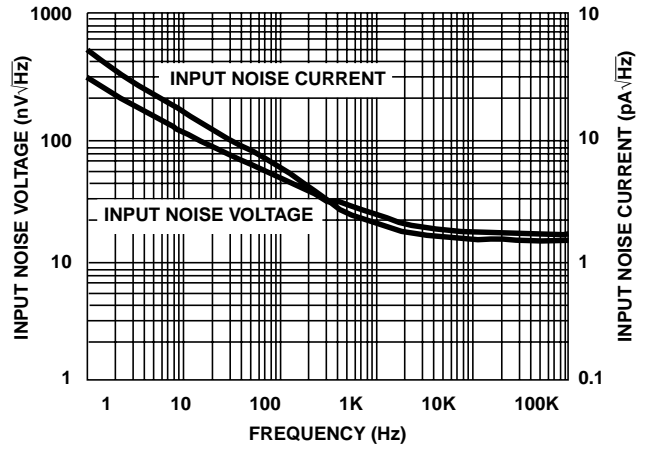
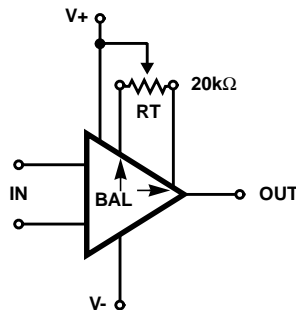

FIGURE 15. INPUT NOISE DENSITY vs FREQUENCY

**Suggested VOS Adjustment**



NOTE: Tested offset adjustment range is  $|VOS + 1\text{mV}|$  minimum referred to output. Typical range is  $+20\text{mV}$  to  $-18\text{mV}$  with  $R_T = 20\text{k}\Omega$ .

**Burn-In Circuits**

HS7-2520 CERDIP

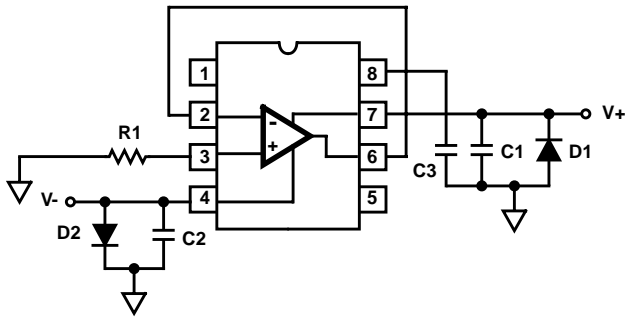

NOTES:

1. R1 = 1M $\Omega$ ,  $\pm$ 5%, 1/4W (Min)
2. C1 = C2 = 0.01 $\mu$ F/Socket (Min) or 0.1 $\mu$ F/Row (Min)
3. C3 = 0.01 $\mu$ F ( $\pm$ 10%)/Socket
4. D1 = D2 = 1N4002 or equivalent (per board)
5. |(V+) - (V-)| = 31V

HS2-2520 METAL CAN

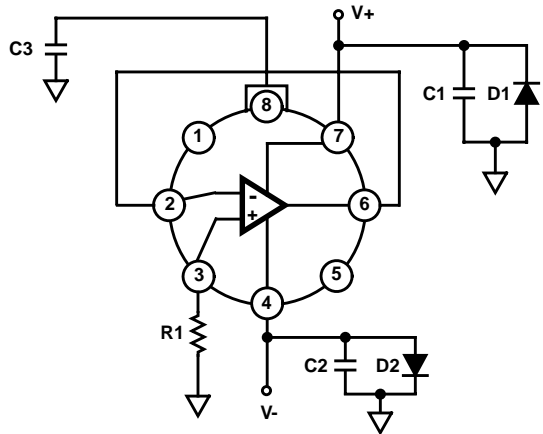

NOTES:

6. R1 = 1M $\Omega$ ,  $\pm$ 5%, 1/4W (Min)
7. C1 = C2 = 0.01 $\mu$ F/Socket (Min) or 0.1 $\mu$ F/Row (Min)
8. C3 = 0.01 $\mu$ F ( $\pm$ 10%)/Socket
9. D1 = D2 = 1N4002 or equivalent (per board)
10. |(V+) - (V-)| = 31V

**Irradiation Circuits**

IRRADIATION CIRCUIT

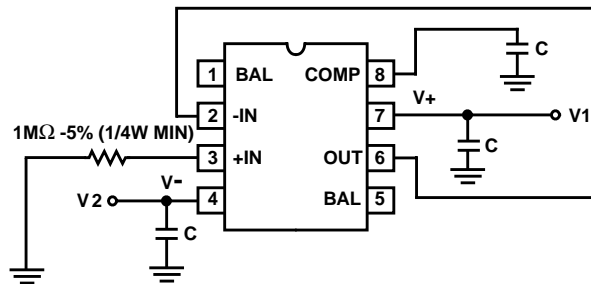

NOTES:

11. V1 = +15V  $\pm$ 10%
12. V2 = -15V  $\pm$ 10%
13. C = 0.1 $\mu$ F  $\pm$ 10%

Schematic Diagram

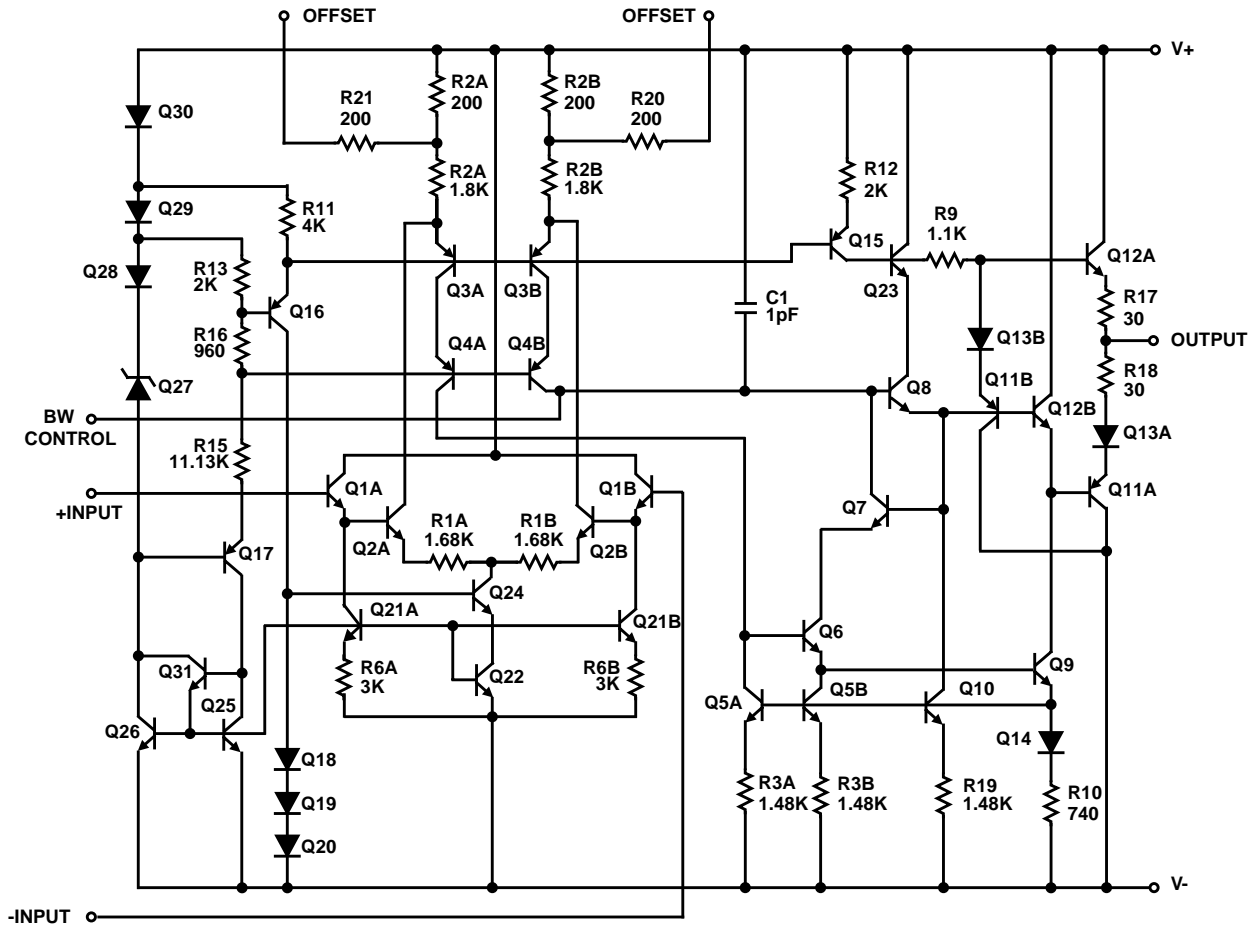

**Die Characteristics**

**DIE DIMENSIONS:**

65 mils x 50 mils x 19 mils  
(1660µm x 1270µm x 483µm)

**INTERFACE MATERIALS:**

**Glassivation:**

Type: Nitride  
Thickness: 7kÅ ±0.7kÅ

**Top Metallization:**

Type: Aluminum  
Thickness: 16kÅ ±2kÅ

**Substrate:**

Linear Bipolar, DI

**Backside Finish:**

Silicon

**ASSEMBLY RELATED INFORMATION:**

**Substrate Potential (Powered Up):**  
Unbiased

**ADDITIONAL INFORMATION:**

**Worst Case Current Density:**  
<math>2 \times 10^5 \text{ A/cm}^2</math>

**Transistor Count:**  
40

**Metallization Mask Layout**

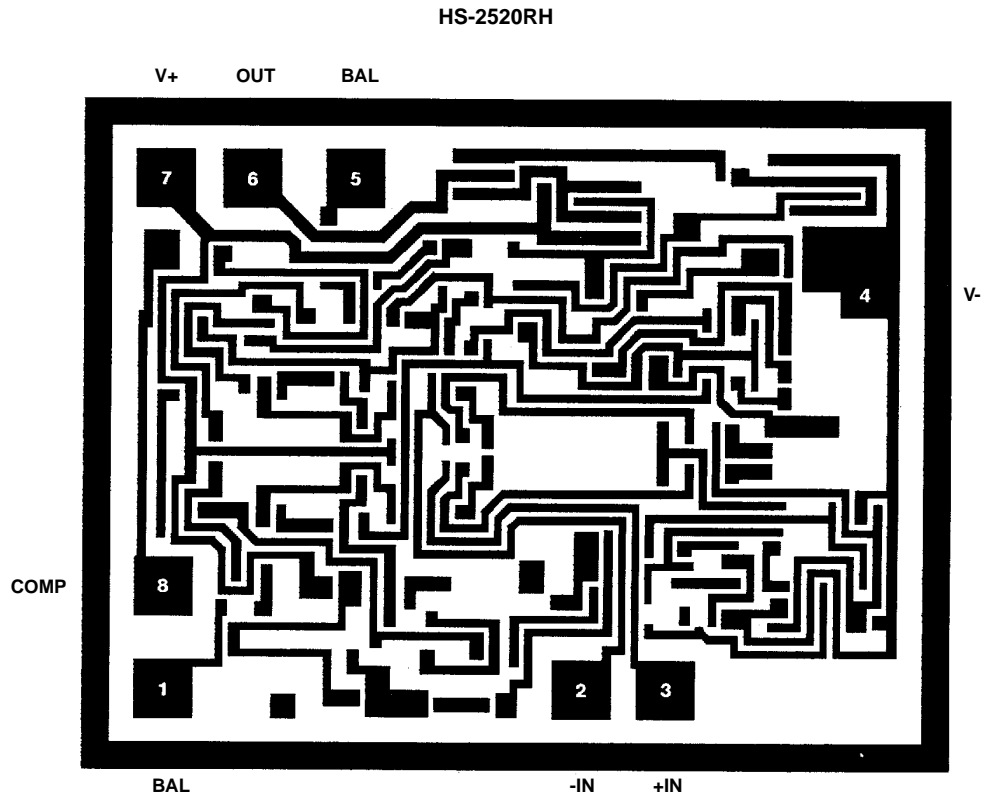

All Intersil semiconductor products are manufactured, assembled and tested under **ISO9000** quality systems certification.

*Intersil semiconductor products are sold by description only. Intersil Corporation reserves the right to make changes in circuit design and/or specifications at any time without notice. Accordingly, the reader is cautioned to verify that data sheets are current before placing orders. Information furnished by Intersil is believed to be accurate and reliable. However, no responsibility is assumed by Intersil or its subsidiaries for its use; nor for any infringements of patents or other rights of third parties which may result from its use. No license is granted by implication or otherwise under any patent or patent rights of Intersil or its subsidiaries.*

For information regarding Intersil Corporation and its products, see web site <http://www.intersil.com>