



Beam Lead Schottky Diodes for Mixers and Detectors (1–26 GHz)

Technical Data

HSCH-5300 Series

Features

- **Platinum Tri-Metal System**
High Temperature Stability
- **Silicon Nitride Passivation**
Stable, Reliable Performance
- **Low Noise Figure**
Guaranteed 7.5 dB at 26 GHz
- **High Uniformity**
Tightly Controlled Process
Insures Uniform RF Characteristics
- **Rugged Construction**
4 Grams Minimum Lead Pull
- **Low Capacitance**
0.10 pF Max. at 0 V
- **Polyimide Scratch Protection**

Description

These beam lead diodes are constructed using a metal-semiconductor Schottky barrier junction. Advanced epitaxial techniques and precise process control insure uniformity and repeatability of this planar passivated microwave semiconductor. A nitride passivation layer provides immunity from contaminants which could otherwise lead to I_R drift.

The Agilent beam lead process allows for large beam anchor pads for rugged construction (typical 6 gram pull strength) without degrading capacitance.

Outline 07

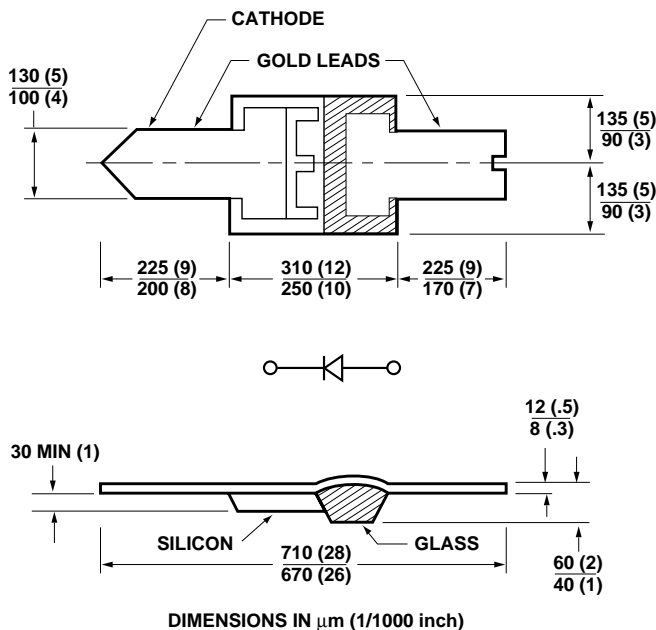

Maximum Ratings

Pulse Power Incident at $T_A = 25^\circ\text{C}$	1 W
Pulse Width = 1 μs , $D_u = 0.001$	
CW Power Dissipation at $T_A = 25^\circ\text{C}$	150 mW
<i>Measured in an infinite heat sink derated linearly to zero at maximum rated temperature</i>	
T_{OPR} – Operating Temperature Range	-65°C to $+175^\circ\text{C}$
T_{STG} – Storage Temperature Range	-65°C to $+200^\circ\text{C}$
Minimum Lead Strength	4 grams pull on any lead
Diode Mounting Temperature	$+350^\circ\text{C}$ for 10 sec. max.

These diodes are ESD sensitive. Handle with care to avoid static discharge through the diode.

Applications

The beam lead diode is ideally suited for use in stripline or microstrip circuits. Its small physical size and uniform dimensions give it low parasitics and repeatable RF characteristics through K-band.

The basic medium barrier devices in this family are DC tested HSCH-5310, -5312, and -5316. A batch matched version is available as the HSCH-5317. Equivalent low barrier devices are HSCH-5330, -5332, and -5336. Batch matched

versions are available as HSCH-5331 and -5333.

For applications requiring guaranteed RF-tested performance up to 26 GHz, the HSCH-5340 is selected with batch match units available as the HSCH-5341. The HSCH-5318 is selected for 6.2 dB maximum noise figure at 9.375 GHz; with RF batch match units available as the HSCH-5319. The HSCH-5314 is rated at 7.2 dB maximum noise figure at 16 GHz with RF batch match units available as the HSCH-5315.

Assembly Techniques

Thermocompression bonding is recommended. Welding or conductive epoxy may also be used. For additional information see Application Note 979, "The Handling and Bonding of Beam Lead Devices Made Easy," or Application Note 993, "Beam Lead Device Bonding to Soft Substrates."

Table IA. Electrical Specifications for RF Tested Diodes at $T_A = 25^\circ\text{C}$

Part Number HSCH-	Batch* Matched HSCH-	Barrier	Max. Noise Figure NF (dB)	I_F Impedance Z_{IF} (Ω)		Max. SWR	Min. Break- down Voltage V_{BR} (V)	Max. Dynamic Resis- tance R_D (Ω)	Max. Total Capaci- tance C_T (pF)	Max. Forward Voltage V_F (mV)	Max. Leakage Current I_R (nA)
				Min.	Max.						
5318	5319	Medium	6.2 at 9.375 GHz	200	400	1.5:1	4	12	0.25	500	100
5314	5315		7.2 at 16 GHz					16			
5340	5341	Low	7.5 at 26 GHz	150	350	1.5:1	4	20	0.10	375	400
Test Conditions	$\Delta NF \leq$ 0.3 dB $\Delta Z_{IF} \leq$ 25 Ω		DC Load Resistance - 0 Ω LO Power = 1 mW $I_F = 30$ MHz, 1.5 dB NF				$I_R \leq 10$ μA	$I_F = 5$ mA	$V_R = 0$ V $f = 1$ MHz	$I_F = 1$ mA	$V_R = 1$ V

*Minimum batch size 20 units.

Note:

1. $C_T = C_J + 0.02$ pF (fringing cap).

Table IB. Electrical Specifications for DC Tested Diodes at $T_A = 25^\circ\text{C}$

Part Number HSCH-	Batch* Matched HSCH-	Barrier	Minimum Breakdown Voltage V_{BR} (V)	Maximum Dynamic Resistance R_D (Ω)	Maximum Total Capacitance C_T (pF)	Maximum Forward Voltage V_F (mV)	Maximum Leakage Current I_R (nA)
5316 5312 5310	5317	Medium	4	12 16 20	0.25 0.15 0.10	500	100
5336 5332 5330	5333 5331	Low	4	12 16 20	0.25 0.15 0.10	375	400
Test Conditions	$\Delta V_F \leq 15$ mV @ 5 mA		$I_R \leq 10$ μA	$I_F = 5$ mA	$V_R = 0$ V $f = 1$ MHz	$I_F = 1$ mA	$V_R = 1$ V

*Minimum batch size 20 units.

Typical Detector Characteristics at $T_A = 25^\circ\text{C}$ **Medium Barrier and Low Barrier (DC Bias)**

Parameter	Symbol	Typical Value	Units	Test Conditions
Tangential Sensitivity	TSS	-54	dBm	20 μA Bias, $R_L = 100$ K Ω Video Bandwidth = 2 MHz $f = 10$ GHz
Voltage Sensitivity	γ	6.6	mV/ μW	
Video Resistance	R_V	1400	Ω	

Low Barrier (Zero Bias)

Parameter	Symbol	Typical Value	Units	Test Conditions
Tangential Sensitivity	TSS	-44	dBm	Zero Bias, $R_L = 10$ M Ω Video Bandwidth = 2 MHz $f = 10$ GHz
Voltage Sensitivity	γ	10	mV/ μW	
Video Resistance	R_V	1.8	M Ω	

SPICE Parameters

Parameter	Units	HSCH-5316 HSCH-5318	HSCH-5312 HSCH-5314	HSCH-5310	HSCH-5330 HSCH-5340	HSCH-5332	HSCH-5336
B_V	V	5	5	5	5	5	5
C_{J0}	pF	0.2	0.13	0.09	0.09	0.13	0.20
E_G	eV	0.69	0.69	0.69	0.69	0.69	0.69
I_{BV}	A	10E-5	10E-5	10E-5	10E-5	10E-5	10E-5
I_S	A	3 x 10E-10	3 x 10E-10	3 x 10E-10	4 x 10E-10	4 x 10E-8	4 x 10E-8
N		1.08	1.08	1.08	1.08	1.08	1.08
R_S	Ω	5	9	13	13	9	6
P_B	V	0.65	0.65	0.65	0.5	0.5	0.5
P_T		2	2	2	2	2	2
M		0.5	0.5	0.5	0.5	0.5	0.5

Typical Parameters

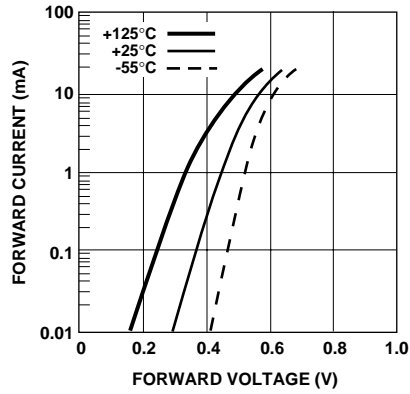

Figure 1. Typical Forward Characteristics for Medium Barrier Beam Lead Diodes. HSCH-5310 Series.

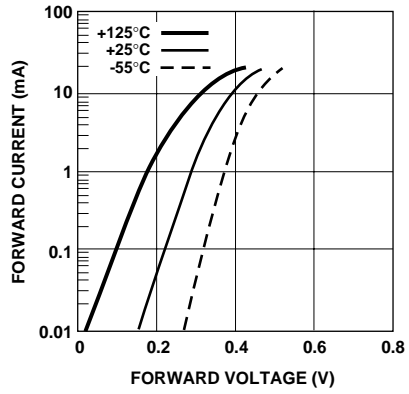

Figure 2. Typical Forward Characteristics for Low Barrier Beam Lead Diodes. HSCH-5330, -5340 Series.

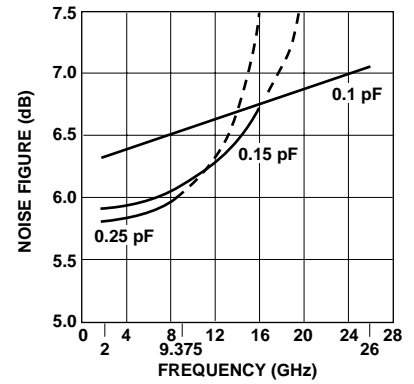

Figure 3. Typical Noise Figure vs. Frequency.

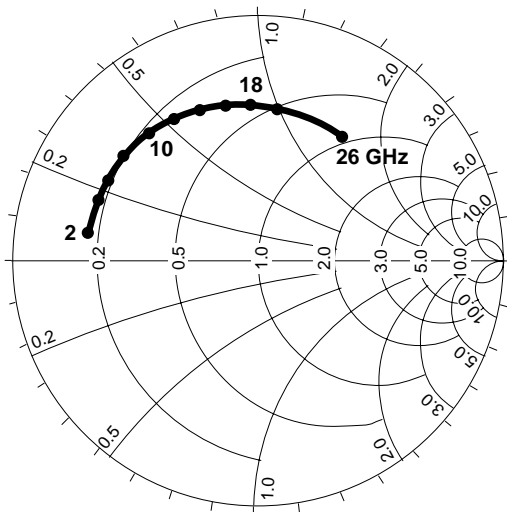

Figure 4. Typical Admittance Characteristics with 1 mA Self Bias. HSCH-5340 and -5341.

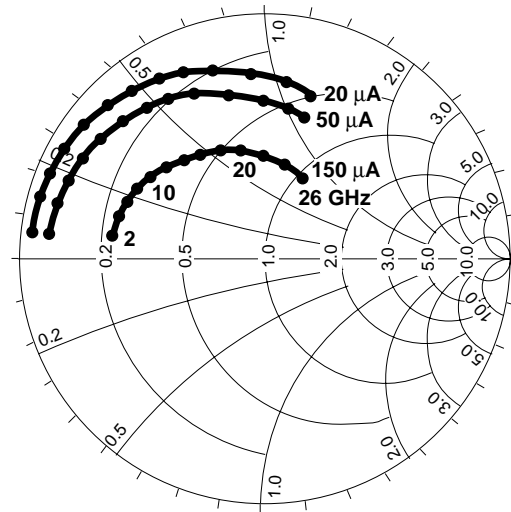

Figure 5. Typical Admittance Characteristics with External Bias. HSCH-5340 and -5341.

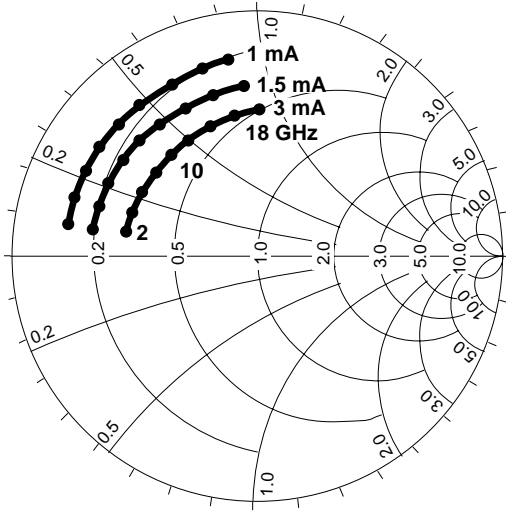

Figure 6. Typical Admittance Characteristics with Self Bias. HSCCH-5314 and -5315.

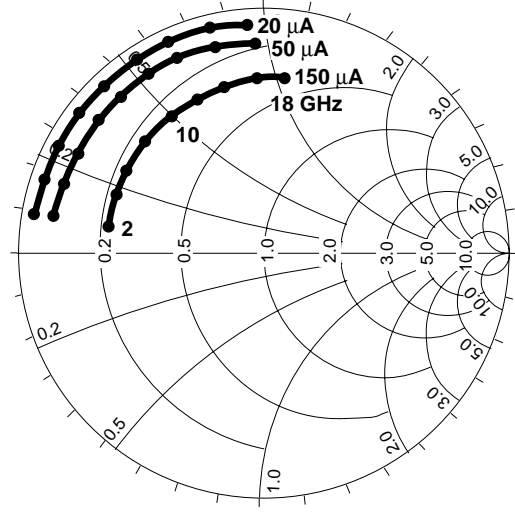

Figure 7. Typical Admittance Characteristics with External Bias. HSCCH-5314 and -5315.

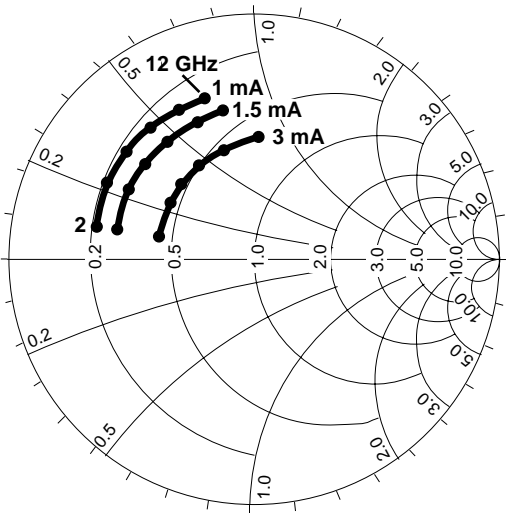

Figure 8. Typical Admittance Characteristics with Self Bias. HSCCH-5318 and -5319.

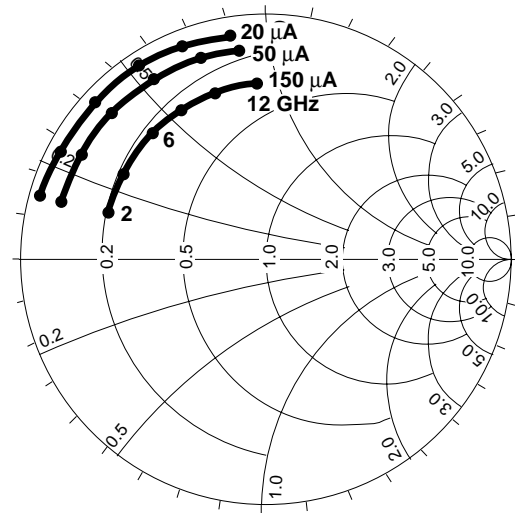
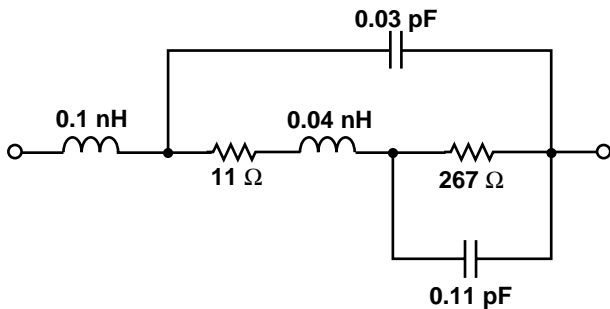

Figure 9. Typical Admittance Characteristics with External Bias. HSCCH-5318 and -5319.

Models for Each Beam Lead Schottky Diode

HSCCH-5340, -5341
1 mA Self Bias





**Other HSCH-53XX
Self Bias**

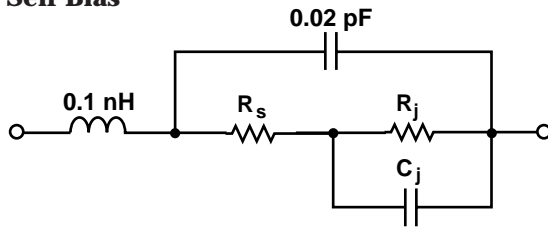

Part Numbers	1.0 mA Self Bias			1.5 mA Self Bias			3.0 mA Self Bias		
	R _S (Ω)	R _J (Ω)	C _J (pF)	R _S (Ω)	R _J (Ω)	C _J (pF)	R _S (Ω)	R _J (Ω)	C _J (pF)
HSCH-5314, -5315	5.0	393	0.11	5.2	232	0.11	5.0	150	0.12
HSCH-5318, -5319	5.1	244	0.16	5.0	178	0.16	5.0	109	0.19

**HSCH-5340, -5341
External Bias**

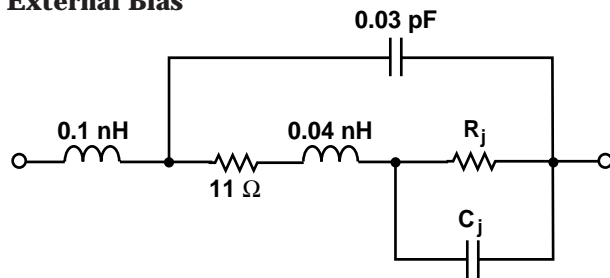

Part Numbers	20 μA DC Bias		50 μA DC Bias		150 μA DC Bias	
	R _J (Ω)	C _J (pF)	R _J (Ω)	C _J (pF)	R _J (Ω)	C _J (pF)
HSCH-5340, -5341	1300	0.09	560	0.09	187	0.10

**Other HSCH-53XX
External Bias**

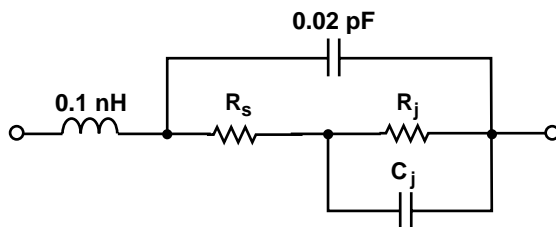

Part Numbers	20 μADC Bias			50 μADC Bias			150 μADC Bias		
	R _S (Ω)	R _J (Ω)	C _J (pF)	R _S (Ω)	R _J (Ω)	C _J (pF)	R _S (Ω)	R _J (Ω)	C _J (pF)
HSCH-5314, -5315	2.8	1300	0.11	4.7	520	0.12	2.7	180	0.13
HSCH-5318, -5319	5.1	1300	0.18	3.9	520	0.19	4.7	180	0.20