

HSMF-C146

Side View SMT ChipLED

Data Sheet



Feature:

- LED with AlInGaP and InGaN die
- Bicolor right angle chipLED
- Compatible with reflow soldering
- Tape in 8mm carrier tape on a 7 inch diameter reel

Application:

- Backlighting
- Status indicator
- Front panel indicator
- Office automation, home appliances, industrial equipment

Package Dimension

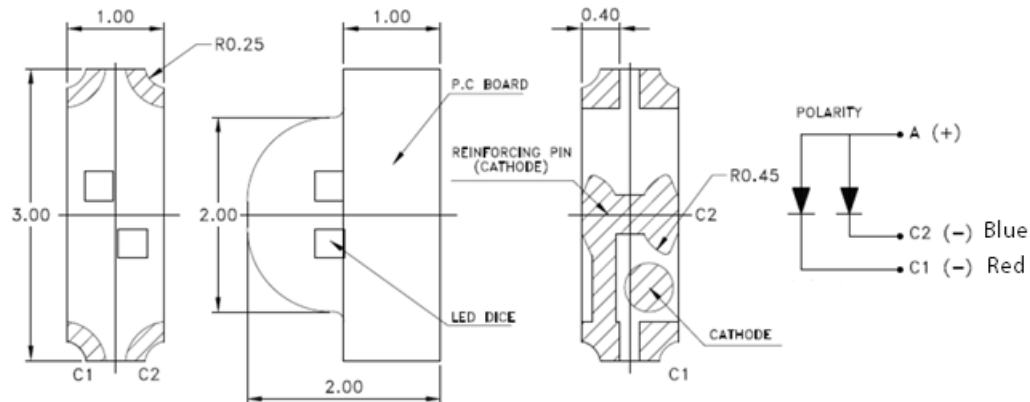

Note:

- All dimensions are in mm.
- Tolerance ± 0.1 mm unless otherwise specified.

Caution: LEDs are class 1A ESD sensitive per ANSI/ESDA/JEDEC JS-001. Please observe appropriate precautions during handling and processing. Refer to Application Note AN-1142 for additional details.

Absolute Maximum Value at T_A = 25°C

Parameter	AlInGaP Red	InGaN Blue	Unit
Forward current ¹	30	20	mA
Power dissipation	72	78	mW
Operating temperature	-30 to 85		°C
Storage temperature	-40 to 85		°C

Note:

1. Derate as shown in Figure 5.

Optical Characteristics at T_A = 25°C, I_F = 20mA

Color	Luminous Intensity (mcd) ¹		Peak Wavelength (nm)	Dominant Wavelength (nm) ²	Viewing Angle (°) ³
	Min	Typ	Typ	Typ	Typ
Red	18.0	79.0	644	632	110
Blue	28.5	75.0	459	464	110

Note:

1. The luminous intensity is measured at the mechanical axis of the lamp package which may not be aligned with the peak of the spatial radiation pattern.
2. The dominant wavelength is derived from the CIE Chromaticity Diagram and represents the perceived color of the device.
3. $\Theta_{1/2}$ is the off axis angle where the luminous intensity is 1/2 the peak intensity.

Electrical Characteristics at T_A = 25°C

Color	Forward Voltage (V) ¹		Reverse Voltage (V) ² at 100μA	Thermal Resistance R _{θj-p} (°C/W)
	Min	Max	Min	Typ
Red	1.6	2.9	5	400
Blue	2.9	3.9	5	300

Note:

1. Forward voltage tolerance is ±0.1V.
2. Reverse voltage Indicates product final testing, long terms reverse bias is not recommended.

Luminous Intensity Bin

Bin	Min (mcd)	Max (mcd)
M	18.0	28.5
N	28.5	45.0
P	45.0	71.5
Q	71.5	112.5
R	112.5	180.0

Tolerance for each bin limit is $\pm 15\%$

Red Color Bin

Bin	Min (nm)	Max (nm)
-	620	635

Tolerance for each bin limit is $\pm 1\text{nm}$

Blue Color Bin

Bin	Min (nm)	Max (nm)
A	460	465
B	465	470
C	470	475
D	475	480

Tolerance for each bin limit is $\pm 0.5\text{nm}$

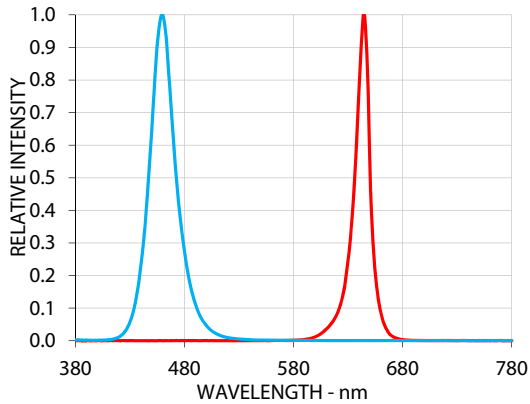

Figure 1. Spectrum

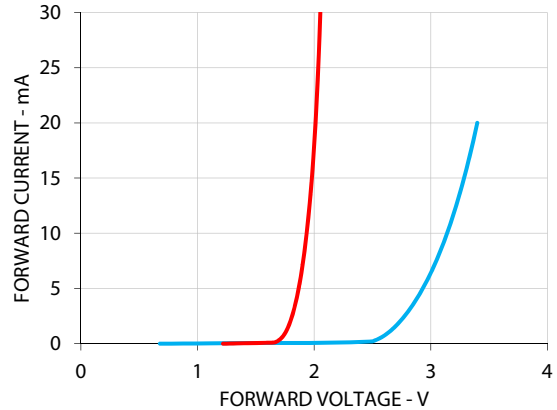

Figure 2. Forward current vs Forward voltage

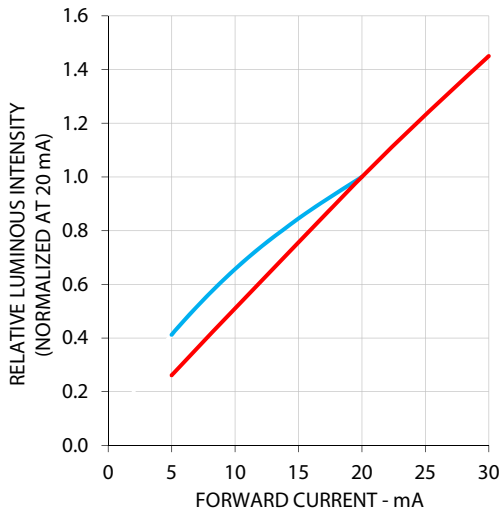

Figure 3. Relative intensity vs Forward current

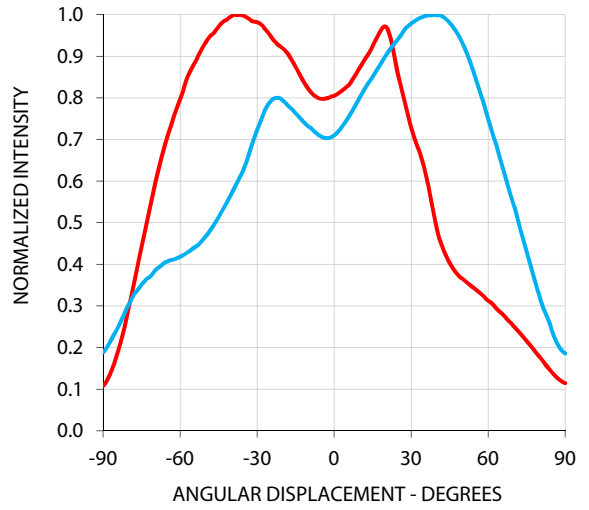

Figure 4. Radiation pattern

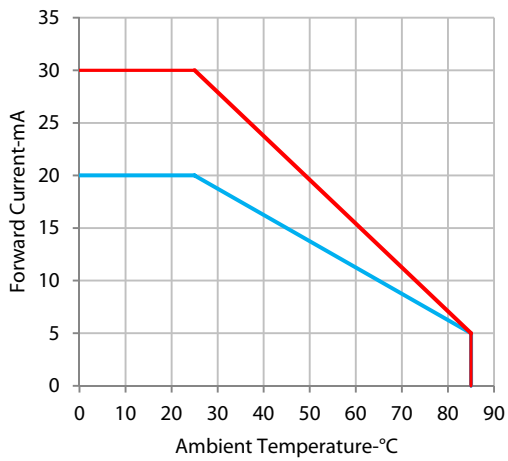

Figure 5. Derating curve

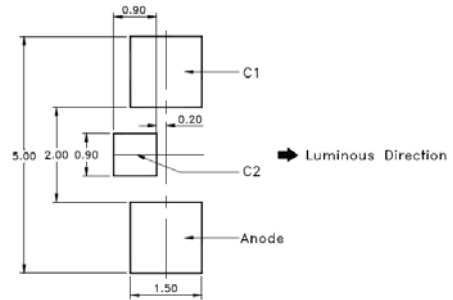

Figure 6. Recommended solder pad

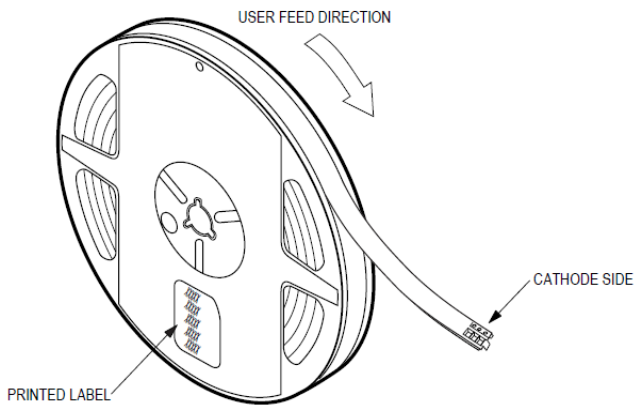

Figure 7. Reel orientation

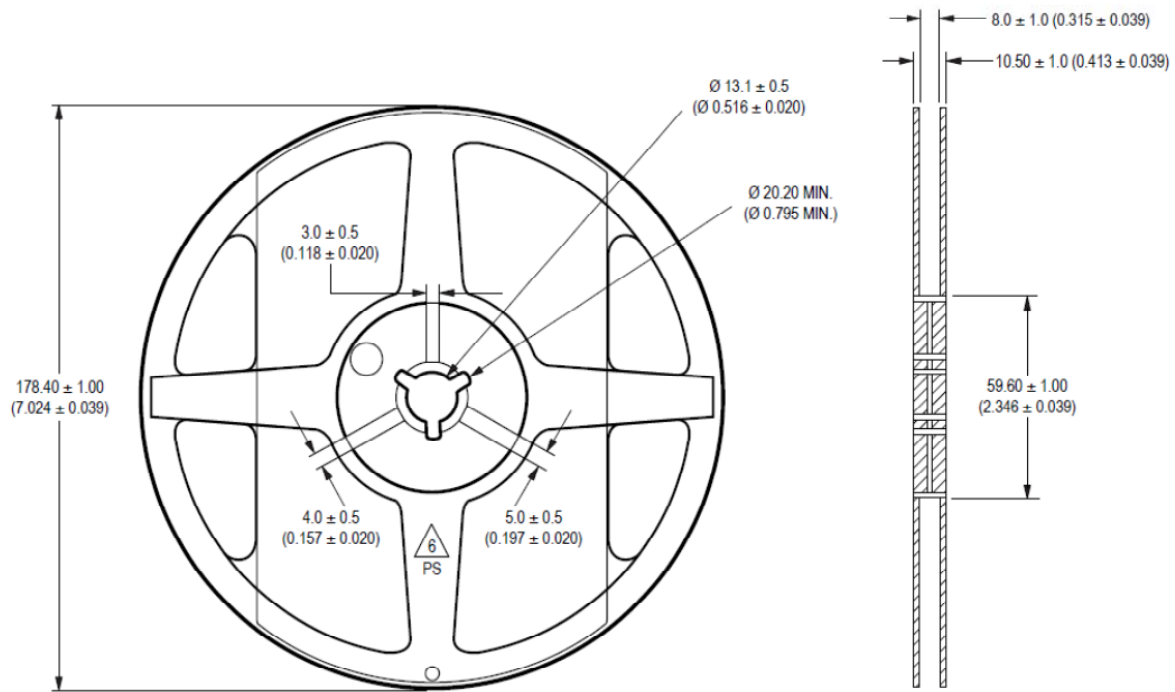

Figure 8. Reel dimension

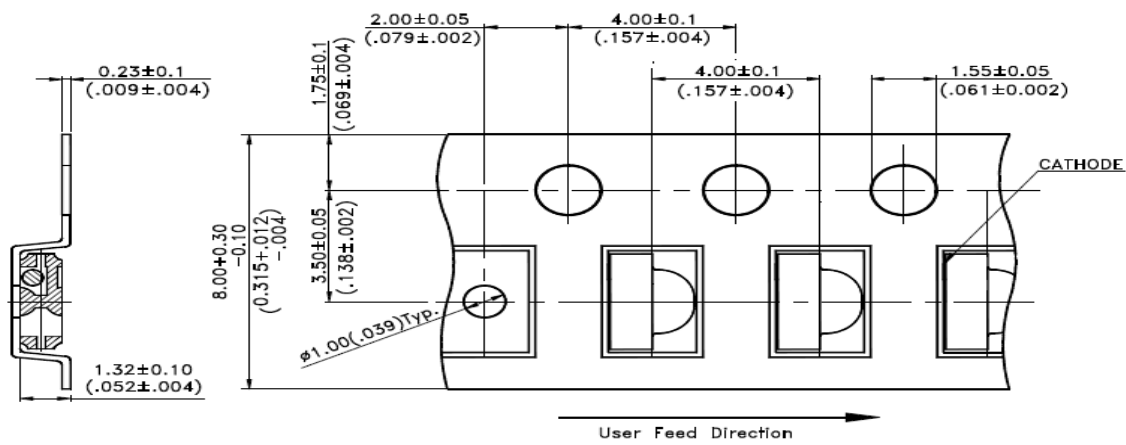
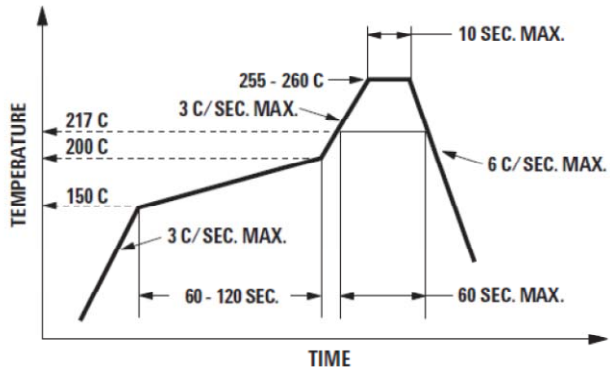

Figure 9. Tape dimension

Soldering

Recommended reflow soldering condition:



- (a) Reflow soldering must not be done more than 2 times. Do observe necessary precautions of handling moisture sensitive device as stated in below section.
- (b) Do not apply any pressure or force on the LED during reflow and after reflow when the LED is still hot.
- (c) It is preferred to use reflow soldering to solder the LED. But if unavoidable (such as rework), manual hand soldering can be used but must be strictly controlled to condition below:
 - Soldering iron tip temperature = 310°C max
 - Soldering duration = 2sec max
 - Number of cycle = 1 only
 - Power of soldering iron = 50W max
- (d) Do not touch the LED package body with the soldering iron except for the soldering terminals as it may cause damage to the LED.
- (e) User is advised to confirm beforehand whether the functionality and performance of the LED is affected by hand soldering.

PRECAUTIONARY NOTES

1. Handling of moisture sensitive device

This product has a Moisture Sensitive Level 2a rating per JEDEC J-STD-020. Refer to Avago Application Note AN5305, *Handling of Moisture Sensitive Surface Mount Devices*, for additional details and a review of proper handling procedures.

(a) Before use

- An unopened moisture barrier bag (MBB) can be stored at <40°C/90%RH for 12 months. If the actual shelf life has exceeded 12 months and the humidity Indicator Card (HIC) indicates that baking is not required, then it is safe to reflow the LEDs per the original MSL rating.
- It is recommended that the MBB not be opened prior to assembly (e.g. for IQC).

(b) Control after opening the MBB

- The humidity indicator card (HIC) shall be read immediately upon opening of MBB.
- The LEDs must be kept at <30°C / 60%RH at all times and all high temperature related processes including soldering, curing or rework need to be completed within 672 hours.

(c) Control for unfinished reel

- Unused LEDs must be stored in a sealed MBB with desiccant or desiccator at <5%RH.

(d) Control of assembled boards

- If the PCB soldered with the LEDs is to be subjected to other high temperature processes, the PCB need to be stored in sealed MBB with desiccant or desiccator at <5%RH to ensure that all LEDs have not exceeded their floor life of 672 hours.

(e) Baking is required if:

- The HIC indicator is not blue at 10% and is pink at 5%.
- The LEDs are exposed to condition of >30°C / 60% RH at any time.
- The LED floor life exceeded 672hrs.

The recommended baking condition is: 60±5°C for 20hrs

Baking should only be done once.

Disclaimer

Avago's products are not specifically designed, manufactured or authorized for sale as parts, components or assemblies for the planning, construction, maintenance or direct operation of a nuclear facility or for use in medical devices or applications. Customer is solely responsible, and waives all rights to make claims against Avago or its suppliers, for all loss, damage, expense or liability in connection with such use.

For product information and a complete list of distributors, please go to our website: www.avagotech.com

Avago, Avago Technologies, and the A logo are trademarks of Avago Technologies in the United States and other countries. Data subject to change. Copyright © 2005-2014 Avago Technologies. All rights reserved.