

# HSMP-386D

## PIN Diode Diversity Switch



### Data Sheet

#### Description

The HSMP-386D is a low cost and high linearity diversity switch designed to operate from 50MHz to 6GHz. HSMP-386D is built with unique 4 PIN diode configuration, and it is housed in a industrial standard low cost miniature SOT-143 package, which will allow board space saving for space constraint application.

HSMP-386D is equipped with -0.35dB IL and -25.40dB ISO @ 900MHz. On the other hand, HSMP-386D is also featuring with 56.83dBm IIP3 and 47.41dBm IP1dB performance @ 900MHz. HSMP-386D is suitable for wireless application that required low distortion diversity switch, such as dect phone, wireless LAN and WiMAX.

#### Features

- Unique configurations in Surface Mount SOT-143
  - Increase Flexibility
  - Save Board Space
  - Reduce Cost
- Switching
  - Low Distortion Switching
  - Low Capacitance
- Low Failure In Time (FIT) Rate <sup>[1]</sup>
- Specifications at 900MHz; IF=10mA (Typ.)
  - Low IL, 0.35dB
  - High ISO, 25.40dB
  - High power handling, IP1dB, 47.41dBm
  - High Linearity, IIP3, 56.83dBm

#### Pin Connections and Package Marking, SOT-143

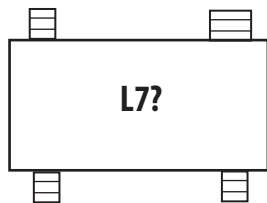
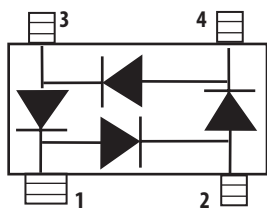

#### Notes:

L7 = Device Code

? = Month code indicates the month of manufacture

**Table 1. Absolute Maximum Rating<sup>[1]</sup> T<sub>c</sub> = +25°C**

Symbol	Parameter	Units	Absolute Max.
I <sub>F</sub>	Forward Current (1μs Pulse)	Amp	1
P <sub>IV</sub>	Peak Inverse Voltage	V	50
T <sub>J</sub>	Junction temperature	°C	150
T <sub>STG</sub>	Storage Temperature	°C	-65 to 150
θ <sub>JC</sub>	Thermal Resistance <sup>[2]</sup>	°C/W	500

Notes:

1. Operation in excess of anyone of these conditions may result in permanent damage to the device.
2. T<sub>c</sub> = 25°C, T<sub>c</sub> where is defined to be the temperature at the package pins where contacts is made to the circuit board.

**Table 2. Electrical Specifications, T<sub>c</sub> = +25°C, each diode**

Symbol	Parameter and Test Condition	Units	Min.	Typ	Max.
V <sub>BR</sub>	Breakdown Voltage @ I <sub>R</sub> = 10μA	V	–	55	–
V <sub>F</sub>	Forward Voltage @ I <sub>F</sub> = 30mA	V	–	0.88	–
V <sub>F</sub>	Forward Voltage @ I <sub>F</sub> = 100mA	V	–	0.96	1.15
R <sub>S</sub>	Typical Series Resistance @ Freq = 100MHz & I <sub>F</sub> = 1mA	Ohm	–	17.0	–
R <sub>S</sub>	Typical Series Resistance @ Freq = 100MHz & I <sub>F</sub> = 10mA	Ohm	–	2.6	–
R <sub>S</sub>	Typical Series Resistance @ Freq = 100MHz & I <sub>F</sub> = 100mA	Ohm	–	1.2	–
C <sub>T</sub>	Typical Total Capacitance @ Freq = 1MHz & V <sub>R</sub> = 0V	pF	–	0.35	0.55
T	Carrier Lifetime @ I <sub>F</sub> = 50mA & I <sub>R</sub> = 250mA	ns	–	500	–
T <sub>rr</sub>	Reverse Recovery Time @ V <sub>R</sub> = 10V, I <sub>F</sub> = 20mA & 90% Recovery	ns	–	75	–

**Table 3. Performance Table at Nominal Operating Conditions, T<sub>c</sub> = +25°C, I<sub>F</sub> = 10mA, each diode**

IIP3 <sup>[1, 4]</sup>	Input 3rd order Intercept Point @ freq = 0.9GHz	dBm	–	56.83	–
IIP3 <sup>[2, 4]</sup>	Input 3rd order Intercept Point @ freq = 1.9GHz	dBm	–	57.93	–
IIP3 <sup>[3, 4]</sup>	Input 3rd order Intercept Point @ freq = 2.4GHz	dBm	–	59.26	–
IP1dB <sup>[4]</sup>	Input 1dB Compressed Power @ freq = 0.9GHz	dBm	–	47.41	–
IP1dB <sup>[4]</sup>	Input 1dB Compressed Power @ freq = 1.9GHz	dBm	–	48.11	–
IP1dB <sup>[4]</sup>	Input 1dB Compressed Power @ freq = 2.4GHz	dBm	–	48.45	–

Notes:

1. 0.9 GHz OIP3 Test Condition : F1 = 0.9 GHz & F2 = 0.905 GHz, Pin = 30 dBm
2. 1.9 GHz OIP3 Test Condition : F1 = 1.9 GHz & F2 = 1.905 GHz, Pin = 30 dBm
3. 2.4 GHz OIP3 Test Condition : F1 = 2.4 GHz & F2 = 2.405 GHz, Pin = 30 dBm
4. Measurement obtained using the demoboard described in Figure 7 & 8.

**HSMP-386D Typical Performance,  $T_c = +25^\circ\text{C}$ , each diode**

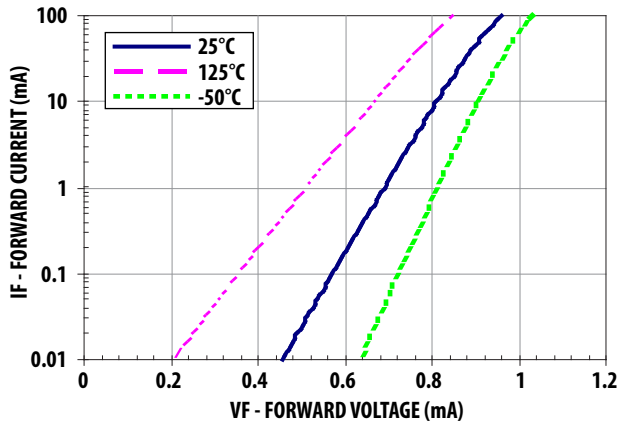

Figure 1. Forward Current vs. Forward Voltage

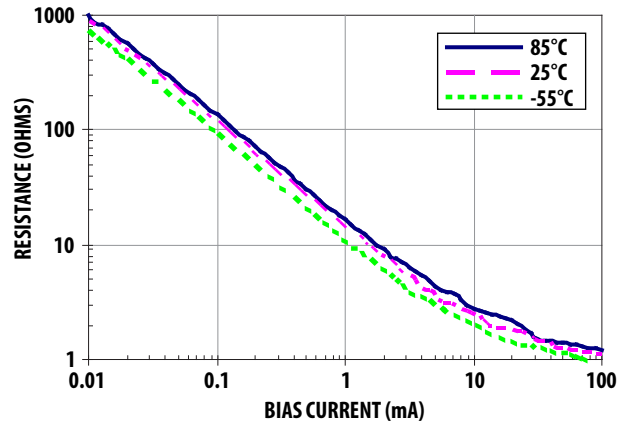

Figure 2. Typical RF Resistance vs. Forward Bias Current

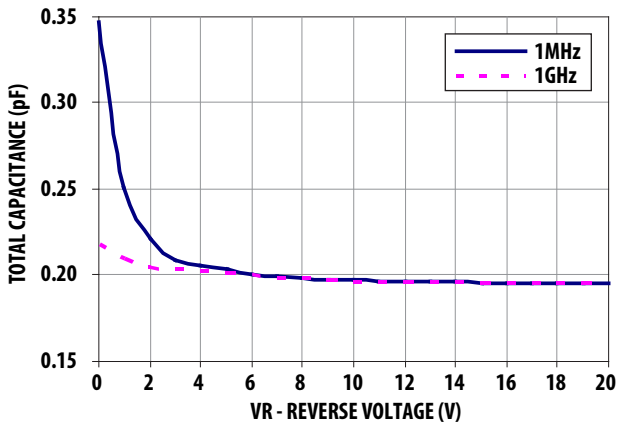

Figure 3. Total Capacitance vs. Reverse Voltage

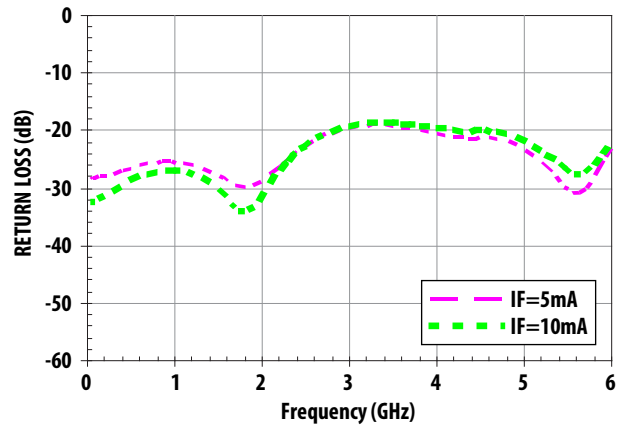

Figure 4. Return Loss vs. Frequency (Pin = 0dBm)

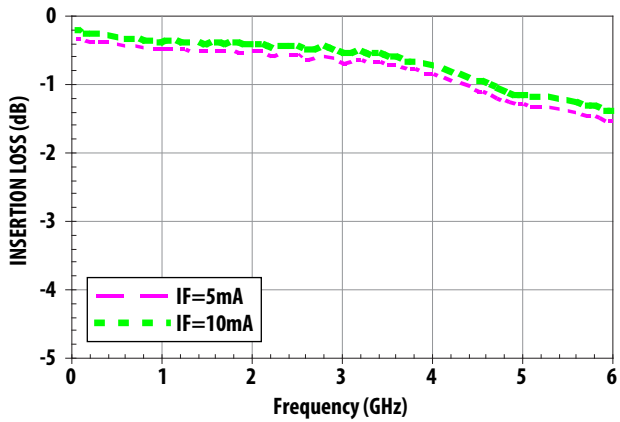

Figure 5. Insertion Loss vs. Frequency (Pin = 0dBm)

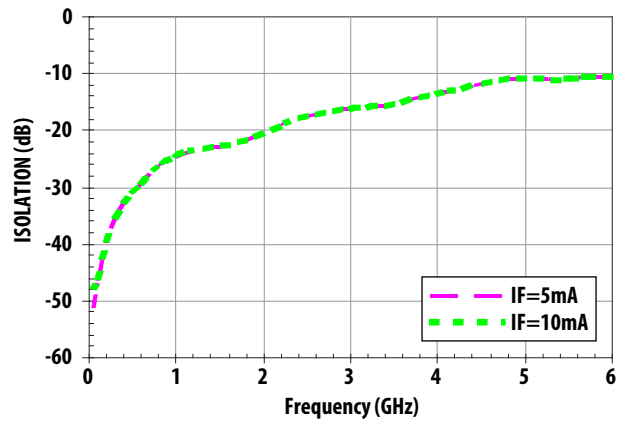

Figure 6. Isolation vs. Frequency (Pin = 0dBm)

### Truth Table

CTR1 (V)	CTR2 (V)	Low Loss paths
$V_F$	0	RF4-RF3 RF1-RF2
0	$V_F$	RF3-RF1 RF2-RF4

### APLAC Model Parameters for PIN Diode

Parameter	Units	PIN Diode
$R_{MAX}$	$K\Omega$	5
$I_S$	A	1.42 E-9
N		1.99
TT	ns	500
C	pF	0.20
A		0.0276
K		0.9018
$R_{MIN}$	$\Omega$	1.10
L	nH	2

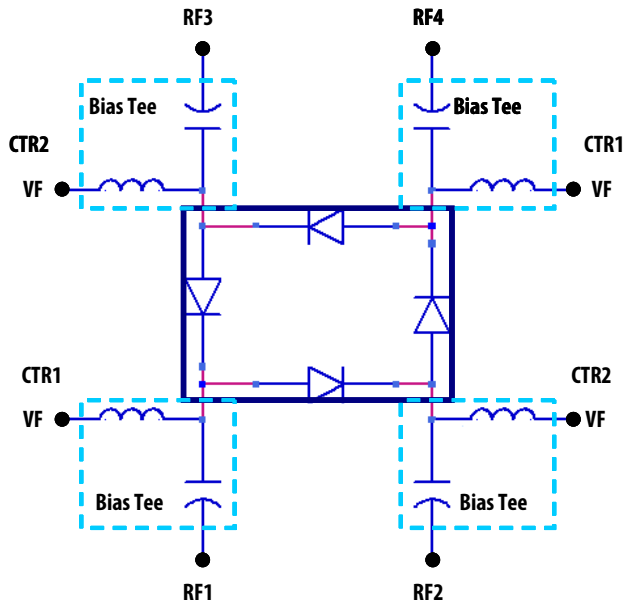

Figure 7. A diagram showing the application circuit for Diversity Switch using HSMF-386D.

This set-up is applicable for measurement shown in Figure 4 – 6.

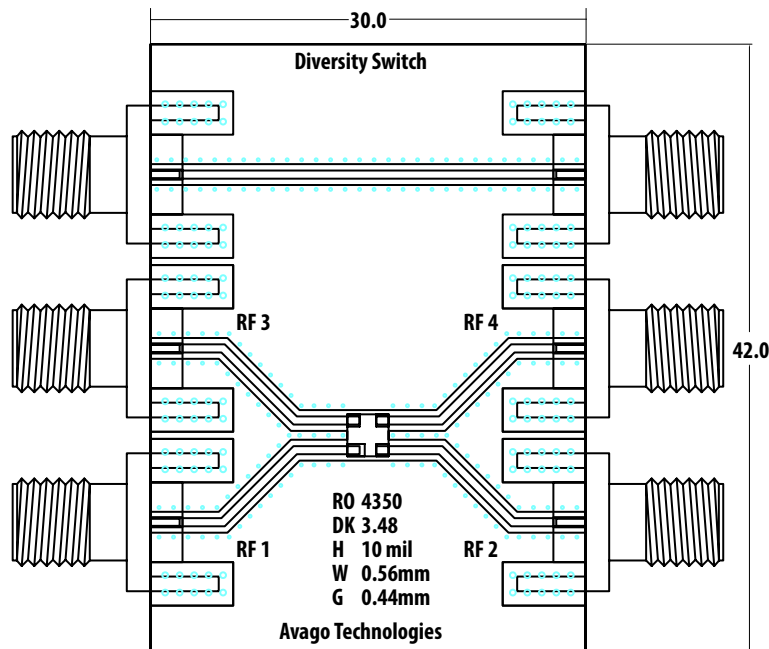
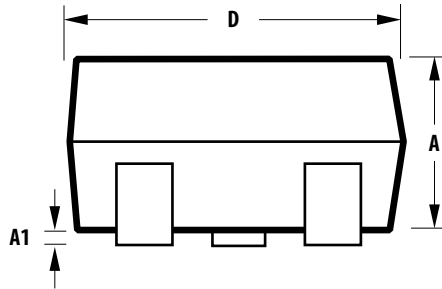
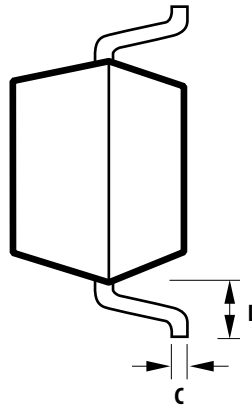
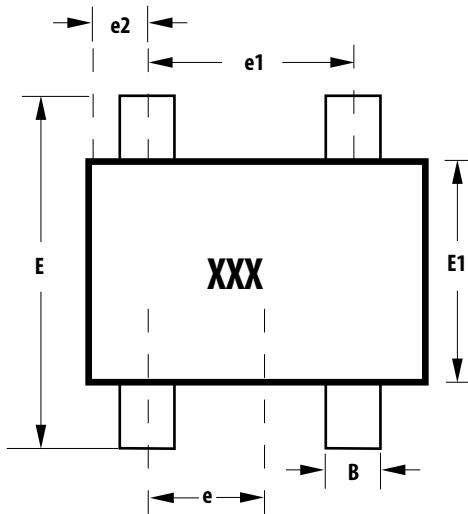

Figure 8. Evaluation Board for Diversity Switch

## Package Outline, SOT-143



**Notes:**

XXX-package marking

Drawings are not to scale

SYMBOL	DIMENSIONS (mm)	
	MIN.	MAX.
A	0.79	1.097
A1	0.013	0.10
B	0.36	0.54
B1	0.76	0.92
C	0.086	0.152
D	2.80	3.06
E1	1.20	1.40
e	0.89	1.02
e1	1.78	2.01
e2	0.45	0.60
E	2.10	2.65
L	0.45	0.69

## Part Number Ordering Information

Part Number	No. of Devices	Container
HSMP-386D-BLK	100	Bulk, per Antistatic bag
HSMP-386D-TR1	3000	Tape & Reel, per 7" Reel
HSMP-386D-TR2	10000	Tape & Reel, per 13" Reel

Tape and Reeling conforms to Electronic Industries RS-481, "Taping of Surface Mounted Components for Automated Placement".

For lead-free option, the part number will have the character "G" at the end, eg. -TR2G for a 10K pc lead-free reel.

## Recommended PCB Pad Layout for AVAGO's SOT-143 Products

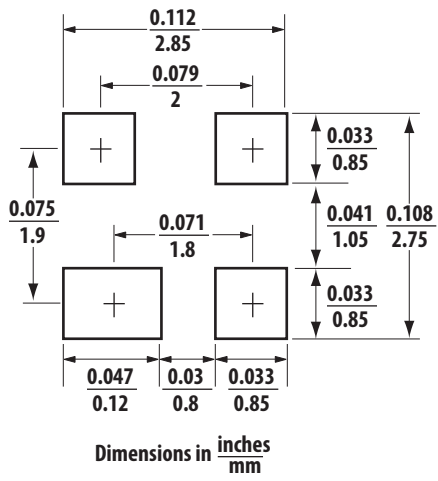

## Device Orientation

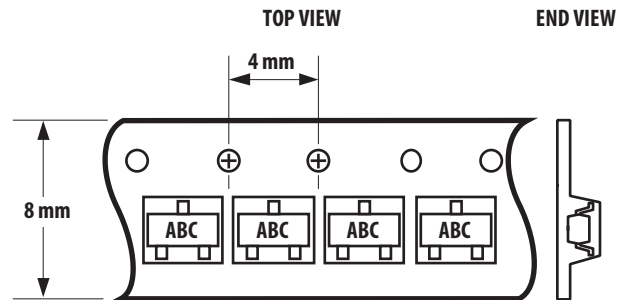
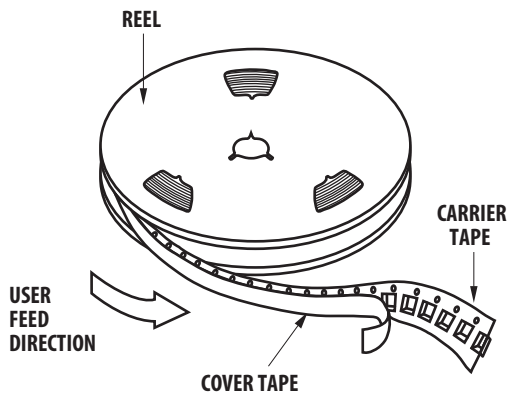

Note: "AB" represents package marking code.  
"C" represents date code.

## Tape Dimensions and Product Orientation

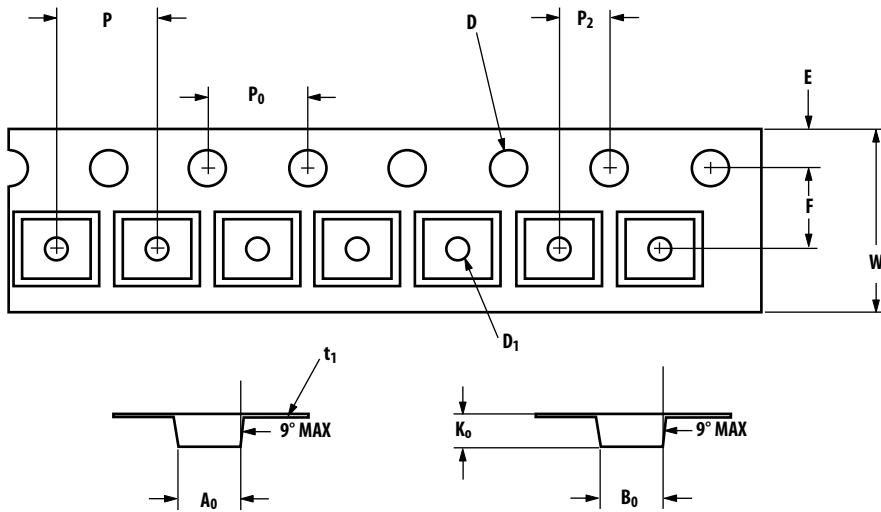

DESCRIPTION		SYMBOL	SIZE (mm)	SIZE (INCHES)
CAVITY	LENGTH	$A_0$	$3.19 \pm 0.10$	$0.126 \pm 0.004$
	WIDTH	$B_0$	$2.80 \pm 0.10$	$0.110 \pm 0.004$
	DEPTH	$K_0$	$1031 \pm 0.10$	$0.052 \pm 0.004$
	PITCH	$P$	$4.00 \pm 0.10$	$0.157 \pm 0.004$
	BOTTOM HOLE DIAMETER	$D_1$	$1.00 \pm 0.25$	$0.039 \pm 0.010$
PERFORATION	DIAMETER	$D$	$1.50 \pm 0.10$	$0.059 \pm 0.004$
	PITCH	$P_0$	$4.00 \pm 0.10$	$0.157 \pm 0.004$
	POSITION	$E$	$1.75 \pm 0.10$	$0.069 \pm 0.004$
CARRIER TAPE	WIDTH	$W$	$8.00 + 0.30 - 0.10$	$0.315 + 0.012 - 0.004$
	THICKNESS	$t_1$	$0.254 \pm 0.013$	$0.0100 \pm 0.0005$
DISTANCE	CAVITY TO PERFORATION (WIDTH DIRECTION)	$F$	$3.50 \pm 0.05$	$0.138 \pm 0.002$
	CAVITY TO PERFORATION (LENGTH DIRECTION)	$P_2$	$2.00 \pm 0.05$	$0.079 \pm 0.002$

For product information and a complete list of distributors, please go to our web site: [www.avagotech.com](http://www.avagotech.com)

Avago, Avago Technologies, and the A logo are trademarks of Avago Technologies in the United States and other countries. Data subject to change. Copyright © 2005-2009 Avago Technologies. All rights reserved.  
AV02-1689EN - January 13, 2009

**AVAGO**  
TECHNOLOGIES